



# Azeer Home Ventilation



HOSPITAL    HOMECARE    DIAGNOSTICS

EN Instructions for use for devices of type WM 100 TD



**prisma20C**  
**prisma20A**  
**prismaCR**  
**prisma25S**

**prisma25S-C**  
**prisma25ST**  
**prismaLAB**  
**prisma30ST**

Sleep therapy devices

**LÖWENSTEIN**  
medical

# Contents

<b>1</b>	<b>Introduction</b>	<b>4</b>
1.1	Intended use .....	4
1.2	Function .....	4
1.3	User qualifications .....	5
1.4	Indications .....	5
1.5	Contraindications .....	6
1.6	Side effects .....	6
<b>2</b>	<b>Safety</b>	<b>7</b>
2.1	Safety information .....	7
2.2	General information .....	10
2.3	Warnings in this document .....	11
<b>3</b>	<b>Product description</b>	<b>12</b>
3.1	Therapy device overview .....	12
3.2	Display .....	13
3.3	Accessories .....	18
<b>4</b>	<b>Preparation</b>	<b>19</b>
4.1	Setting up the therapy device .....	19
4.2	Connecting up the power supply .....	19
<b>5</b>	<b>Operation</b>	<b>23</b>
5.1	Navigating the menu .....	23
5.2	Switching on the therapy device .....	23
5.3	Switching off the therapy device .....	25
5.4	Starting the therapy .....	25
5.5	Ending the therapy .....	26
5.6	Performing a mask test .....	27
5.7	Switching softSTART on/off .....	28
5.8	Setting the respiratory air humidifier .....	29
5.9	Setting the alarm .....	31
5.10	Viewing therapy data and device information .....	32
5.11	Using the SD card .....	35

<b>6</b>	<b>Settings in the menu</b>	<b>38</b>
6.1	Setting comfort parameters .....	38
6.2	Setting accessories parameters .....	39
6.3	Setting time parameters .....	40
6.4	Setting device parameters .....	40
<b>7</b>	<b>Hygienic preparation</b>	<b>42</b>
7.1	General information .....	42
7.2	Cleaning intervals .....	42
7.3	Hygienic preparation of the therapy device .....	43
7.4	Hygienic preparation of the respiration hose .....	45
<b>8</b>	<b>Function check</b>	<b>46</b>
8.1	Intervals .....	46
8.2	Checking the therapy device .....	46
<b>9</b>	<b>Alarms and error messages</b>	<b>47</b>
9.1	Alarms .....	47
9.2	Faults in the therapy device .....	49
9.3	Display messages .....	50
<b>10</b>	<b>Maintenance</b>	<b>51</b>
<b>11</b>	<b>Transport and storage</b>	<b>51</b>
<b>12</b>	<b>Disposal</b>	<b>51</b>
<b>13</b>	<b>Appendix</b>	<b>52</b>
13.1	Technical Data .....	52
13.2	Emission of electromagnetic interference .....	61
13.3	Electromagnetic interference immunity .....	61
13.4	Electromagnetic interference immunity for ME equipment and ME systems .....	63
13.5	Labels and symbols .....	64
13.6	Scope of supply .....	66
13.7	Warranty .....	67
13.8	Declaration of conformity .....	67

# 1 Introduction

## 1.1 Intended use

The WM 100 TD devices are pressure-controlled, non-invasive, non-life-sustaining therapy devices for the treatment of sleep disordered breathing (SDB) or intermittent treatment of respiratory insufficiency by means of a mask.

The devices can be used on persons weighing above 30 kg. The CPAP mode can be used on persons above the age of 3 years. The device may only be used on the instruction of a physician.

The WM 100 TD devices are used in clinical facilities and in domestic situations. In domestic situations, the devices are also taken on trips.

## 1.2 Function

The fan in the therapy device sucks ambient air in through a filter, compresses it, and routes it to the device outlet.

From here, the air flows through the hose system and the mask to the patient. The exhalation system in front of the mask, or optionally integrated in the mask, prevents CO<sub>2</sub>-enriched exhaled air from collecting in the hose system.

The therapy device determines and analyzes the pressure and respiratory flow signal. This allows respiratory events to be recognized.

The device can function with one pressure level (CPAP) or with two or three pressure levels (BiLevel or inspiratory pressure, expiratory pressure, and end-expiratory pressure). Depending on the version employed, the pressure levels can be set automatically by the device within preset limits, or they can be set manually. Depending on the mode, the pressure can be continually applied at one level, or triggered by the patient, or applied with time controls. Pressure signals, respiratory flow signals, and respiratory events can be saved and/or can be output in analog form on a PSG system.

The therapy data are saved in the device and on an SD card for therapy monitoring.

The device is operated via an On/Off button and a touchscreen.

The device can be remotely controlled using the prismaTS therapy software.

In the case of a power failure, the settings are retained and the therapy is continued once the power supply is restored.

## 1.3 User qualifications

The person operating the device is referred to in these instructions for use as the "user". In contrast, a "patient" is the person receiving the therapy. Always perform all the operating steps in accordance with these instructions for use.

## 1.4 Indications

### **prisma20C**

CPAP therapy device for the treatment of patients with obstructive sleep apnea with a constant pressure requirement.

### **prisma20A**

APAP therapy device for the treatment of patients with obstructive sleep apnea with a variable pressure requirement. The therapy pressure adjusts automatically to suit the patient's pressure requirement.

### **prismaCR**

Therapy device for the treatment of patients with periodic breathing or Cheyne-Stokes respiration (e.g., in cases of heart failure) as well as with central, mixed, or complex sleep apnea. The therapy device adjusts the ventilation automatically and continually to the changing requirements of the patient.

### **prisma25S**

BiLevel therapy device for the treatment of patients with obstructive, mixed, or complex sleep apnea, and a high and/or fluctuating pressure requirement, poor CPAP compliance. The device has different pressure levels during inspiration and expiration.

### **prisma25S-C**

BiLevel therapy device for the treatment of patients with obstructive, mixed, or complex sleep apnea and a high pressure requirement, poor CPAP compliance. The device has different pressure levels during inspiration and expiration.

### **prisma25ST**

BiLevel therapy device for the treatment of patients with obstructive, mixed, or complex sleep apnea and a high and/or fluctuating pressure requirement, poor CPAP compliance, central apneas, sleep-related or position-dependent hypoventilation (e.g., OHS), respiratory insufficiency, coprevalent respiratory insufficiency (e.g., COPD/overlap). The device has different pressure levels during inspiration and expiration and a backup frequency for the treatment of central events.

**prisma30ST**

BiLevel therapy device for the treatment of patients with obstructive, mixed, or complex sleep apnea and/or chronically reduced respiratory drive (e.g., sleep-related or position-dependent hypoventilation or chronically stable OHS), respiratory insufficiency, e.g., COPD.

**1.5 Contraindications**

The following contraindications are known – the physician in charge is responsible for deciding whether to use the therapy device in each individual case.

Acute cardiac decompensation, severe arrhythmia, severe hypotension, particularly in combination with intravascular volume depletion, severe epistaxis, high risk of a barotrauma, severe chronic/decompensated pulmonary conditions, pneumothorax or pneumomediastinum, pneumocephalus, cranial trauma, status following brain surgery or surgical intervention on the pituitary gland or the middle/inner ear, acute sinus infection (sinusitis), middle ear infection (otitis media) or perforated eardrum, dehydration.

**prismaCR**

Symptomatic chronic systolic heart failure (NYHA 2-4) with reduced left ventricular ejection fraction (LVEF  $\leq$  45%) and moderate to severe predominant central sleep apnea (AHI 15/h, CAHI/AHI 50% and CAI 10/h)

**1.6 Side effects**

The following undesirable side effects may occur when using the therapy device for short or long periods of time: pressure marks from the respiratory mask and the forehead cushion on the face, flush of the facial skin, nasal congestion, dry nose, morning xerostomia (dry mouth), sensation of pressure in the sinuses, irritated conjunctiva, gastrointestinal air insufflation ("bloating"), epistaxis.

These side effects are general side effects associated with therapy using a sleep therapy device and are not specially linked to the use of WM 100 TD devices.

## 2 Safety

Please read these instructions for use carefully. They form part of the devices described, and must be available at all times.

Use the unit for the designated purpose only (see "1.1 Intended use", page 4).

For your own safety and that of your patients, and in accordance with the requirements of Directive 93/42/EEC, please observe the following safety instructions.

### 2.1 Safety information

#### 2.1.1 Safe use of the therapy device, components, and accessories

**WARNING**

***Risk of injury due to device or component malfunction!***

A damaged device or damaged components may result in injury to the patient, user or bystanders.

- ⇒ Only operate the device and components if they are externally undamaged.
- ⇒ Only operate the device and components if the function check has been successfully completed.
- ⇒ Only operate the device if the display is functional.

***Risk of injury if the device is operated outside the prescribed ambient conditions!***

Use of the device outside the prescribed ambient conditions can result in failure to comply with tolerances, device failures, and injury to the patient.

- ⇒ Only operate the device within the prescribed ambient conditions (see "13.1 Technical Data", page 52).

***Risk of injury if disposable items are reused!***

Disposable items are only intended to be used once. Reused disposable items may be contaminated and/or not function correctly and thus cause patient injury.

- ⇒ Do not reuse disposable items.

***Risk of infection when reusing therapy device!***

When the therapy device is used by multiple patients, infections may be passed on to the next patient.

- ⇒ Use a bacteria filter
- ⇒ When the device is used without a bacteria filter: Have the device hygienically prepared by the manufacturer or an authorized dealer.

---

**⚠ WARNING**
***Treatment prevented due to increased resistance when bacteria filters are used!***

Misting or moistening can increase the resistance of the bacteria filters, thereby modifying the output of the therapy pressure.

- ⇒ Check bacteria filters regularly for increased resistance and blockages and rectify these.
- 

## 2.1.2 Power supply

---

**⚠ CAUTION**
***Risk of injury due to inaccessible power plug!***

An obstructed power plug cannot be pulled out in an emergency and can thus result in injury.

- ⇒ Keep the power plug and power supply accessible at all times.

***Risk of injury and material damage as a result of insufficient power supply!***

Operation of the device outside the specified power supply range can injure the user and damage the device.

- ⇒ Only operate the device with the supplied power supply unit at voltages from 100 V to 240 V.
  - ⇒ Use the DC adapter for operation at voltages from 12 V or 24 V.
- 

## 2.1.3 Transport

---

**NOTICE**
***Water in the device can cause material damage!***

If the device is tilted severely, the residual water from the respiratory air humidifier can enter the device and damage it.

- ⇒ Do not transport or tilt the device when the respiratory air humidifier is filled.

***Dirt in the device can cause material damage!***

Dirt entering the device during transport can damage the device.

- ⇒ Only transport the device with the cover in position.
  - ⇒ Transport the device in the corresponding transport bag.
-

## 2.1.4 Therapy

---

### **WARNING**

#### ***The use of oxygen in combination with flammable substances poses a fire hazard!***

Oxygen in combination with flammable substances can result in spontaneous explosions. In cases of insufficient ventilation, oxygen in the surrounding area (e.g., clothes, hair, bedclothes) can become enriched and cause fires and thus injuries to the patient, user, and others in the immediate vicinity.

- ⇒ Do not smoke.
- ⇒ Do not use naked flames.
- ⇒ Ensure sufficient ventilation.
- ⇒ Use an oxygen safety valve.
- ⇒ Keep the device and screwed unions free from oil and grease.
- ⇒ Always replace splashguards immediately after use.

#### ***The use of oxygen in combination with flammable substances poses a fire hazard!***

Supplying oxygen without special safety equipment can cause fires and injure people.

- ⇒ Always use an oxygen safety valve.
  - ⇒ Observe the instructions for use for the oxygen safety valve and the oxygen supply unit.
  - ⇒ Set up oxygen sources more than 1 m from the device.
- 

### **CAUTION**

#### ***Prevented therapy and material damage due to dirt in the device or respiratory air humidifier!***

Dirt entering the device can impair the success of the therapy and damage the device.

- ⇒ Use the gray air filter.
- ⇒ If necessary, use the white pollen filter (optional accessory).

#### ***Risk of injury if the patient connection opening becomes hot when uses a hose heating system!***

In combination with the device, the hose heating system generates a somewhat higher temperature at the patient connection opening.

- ⇒ Observe the instructions for use for the hose heating system.
-

## 2.2 General information





- Use of third-party products may lead to functional failures and restricted usability. Biocompatibility may also be compromised. Please note that in these cases, any claim under warranty and liability will be void if neither the accessories nor original spare parts recommended in the instructions for use are used.
- Repairs, servicing, and maintenance should only be carried out by the manufacturer or by a technician expressly authorized by the manufacturer.
- Only connect up the devices and modules permitted in accordance with these instructions for use. The devices must satisfy their respective product standard. Position non-medical devices outside of the patient's immediate vicinity.
- The device is subject to special precautions with regard to EMC (electromagnetic compatibility). Maintain a minimum distance of 30 cm between the device and equipment that emits HF radiation (e.g. cell phones). This also applies to accessories such as antenna cables and external antennas, for example. Ignoring this requirement may lead to the device exhibiting reduced performance characteristics.
- Do not operate the device outside the EMC environment specified for this device (see "1.1 Intended use", page 4) in order to prevent undesired events for the patient or operator due to electromagnetic interference. Do not operate the device if the housing, cables or other equipment for electromagnetic shielding are damaged.
- Do not operate the device in the immediate vicinity of other devices or in a stacked arrangement, otherwise there may be malfunctions. If it is necessary to operate the device in the immediate vicinity of other devices or in a stacked arrangement, keep all the devices under observation to ensure that they are all operating properly.
- Only operate device within the specified ambient conditions (see "13.1 Technical Data", page 52).
- The operator is responsible for ensuring the compatibility of the therapy device and all the connected components and accessories prior to the application with the patient.
- Only use accessory parts from the manufacturer. Third-party electrical connecting cables, in particular, may cause the device to malfunction.
- Only have modifications to the unit carried out by the manufacturer or by a technician expressly authorized by the manufacturer.
- Please observe the chapter on hygienic preparation in order to avoid infection or bacterial contamination (see "7 Hygienic preparation", page 42).

- The operator is responsible for ensuring that the therapy pressure setting is specified individually for each patient according to the device configuration, including accessories, that is to be used.
- The operator is required to regularly assess the effectiveness of the therapy settings.
- Also observe the respective instructions for use for the therapy device, the components, and the accessories.
- Always carry out a function check before using the unit (see "8 Function check", page 46).
- Keep the therapy device and accessories out of the reach of children and pets. Keep the therapy device in its transport case when not in use and when it is being transported.

## 2.3 Warnings in this document

Warnings are used to flag up safety-relevant information.

You will find a warning preceding any action that entails a hazard for persons or equipment.

 <b>DANGER</b>	<b><i>Danger!</i></b> Designates an extremely dangerous situation. Failure to observe this warning will lead to serious, irreversible injury, or death.
 <b>WARNING</b>	<b><i>Warning!</i></b> Designates an extremely dangerous situation. Failure to observe this warning may lead to serious, irreversible, or fatal injury.
 <b>CAUTION</b>	<b><i>Caution!</i></b> Designates a dangerous situation. Failure to observe this warning may lead to minor or moderately serious injury.
<b>NOTICE</b>	<b><i>Notice!</i></b> Indicates a harmful situation. Failure to observe this warning may lead to damage to equipment.
	Designates useful information relating to a particular action.

## 3 Product description

### 3.1 Therapy device overview

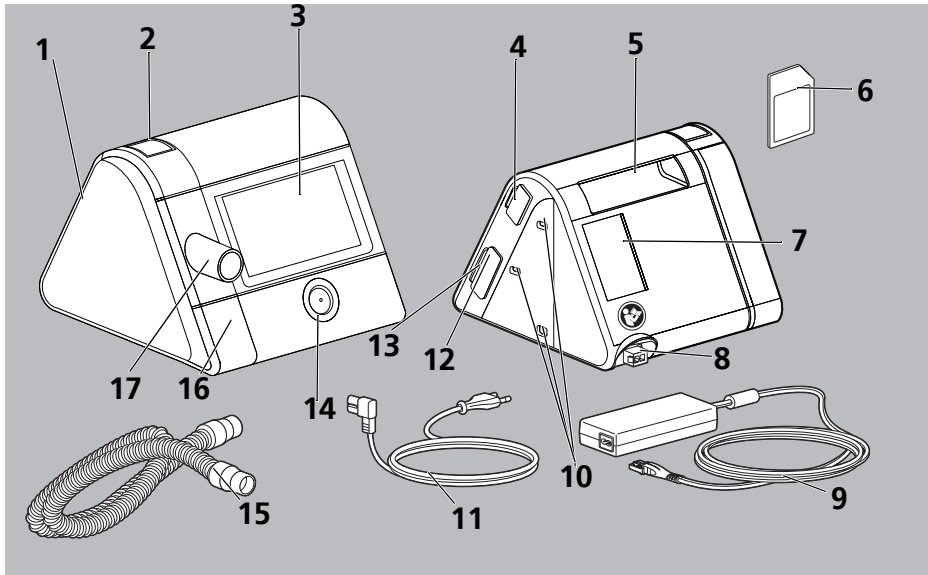

NO.	DESIGNATION	DESCRIPTION
1	Cover	Covers the humidifier connection when no respiratory air humidifier is connected.
2	Unlocking button therapy device	Allows the cover to be removed for connecting the humidifier.
3	Display	Allows operation of the therapy device and the respiratory air humidifier. Displays settings and current values.
4	System interface	Connects the therapy device to modules.
5	Handle	Allows lifting and transporting of the therapy device.
6	SD card	Records therapy data.
7	Filter compartment in the suction area	Houses the air filter and, where applicable, the pollen filter. The respiratory air is sucked in here and the dust particles are filtered out.
8	Power input	Connects the therapy device to the power supply unit.
9	Power supply unit with connection cable	Supplies power to the device. Connects the power supply unit to the therapy device.

NO.	DESIGNATION	DESCRIPTION
10	Mounting holes	For attaching and securing a module to the therapy device.
11	Power supply cable	Connects the power supply unit to the power socket.
12	SD card slot	For inserting an SD card. The symbol on the display indicates the communication between the SD card and the therapy device.
13	Micro USB port	Used for point-to-point connection with a PC on which prismaTS is installed. Allows settings to be changed on the therapy device and data to be exported.
14	On/Off button	Switches the therapy device on and off. Switches the therapy device to standby mode. Starts and stops the therapy.
15	Respiration hose	Connects the therapy device to the respiratory mask.
16	Hose heating system connection	Electrical power supply connection for a heatable hose.
17	Device outlet	Connection for the respiratory hose, through which the patient is supplied with respiratory air.

## 3.2 Display

The information shown on the display depends on the current status of the therapy device:

- **Standby** mode (no therapy in progress)

The therapy device operating hours since therapy began are shown for the first 30 seconds. Then the device switches to the start screen automatically.

The start screen shows the clock and the wake-up time if the alarm clock is set. (see "3.2 Display", page 13).

Settings can be performed on the therapy device (see "6 Settings in the menu", page 38).

- **Therapy** mode (therapy in progress)

Therapy is in progress (see "3.2.2 Display in Therapy mode", page 15).

You can perform the mask test and start the softSTART sleep aid (see "5 Operation", page 23).

- **Energy-saving** mode

The therapy device is supplied with a very low level of power; nothing is shown on the display. You can return to Standby mode by pressing the On/Off button .

### 3.2.1 Display in Standby mode (Start screen)

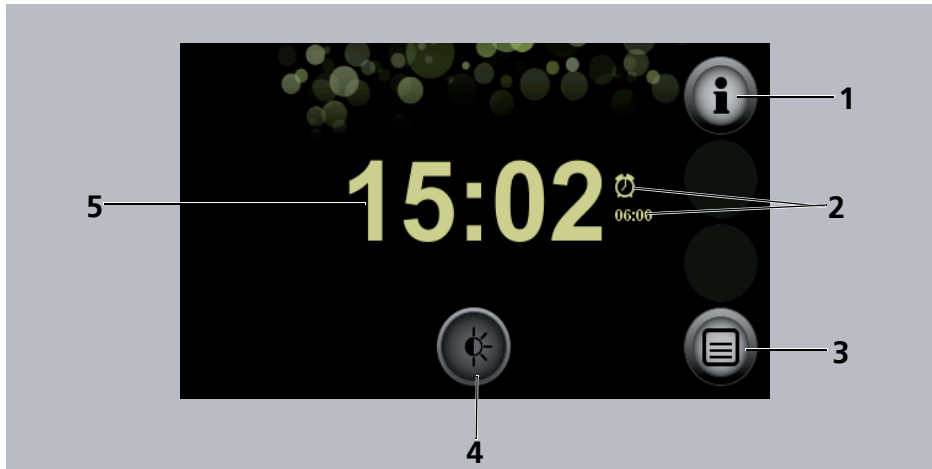





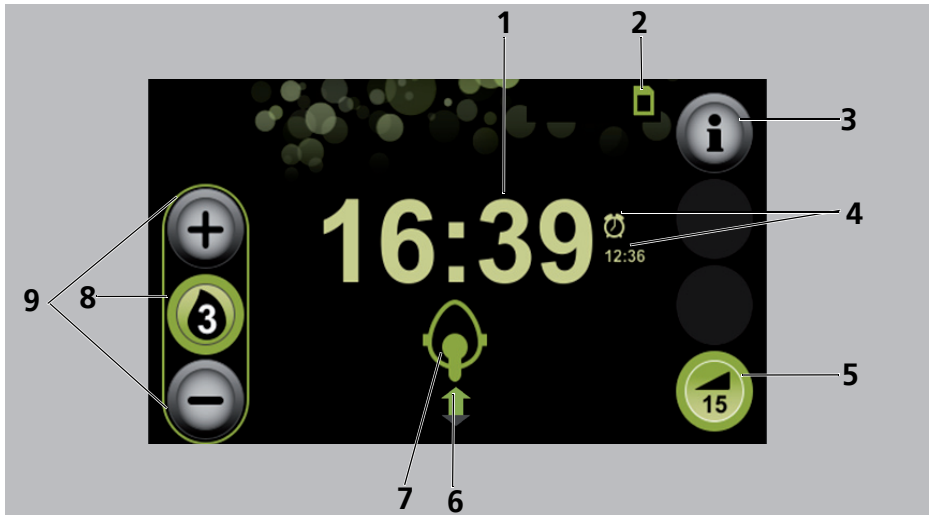





NO.	DESIGNATION	DESCRIPTION
1	Info menu button	Provides access to the info menu.
2	Alarm clock with wake-up time	Alarm clock is set. Displays the set wake-up time.
3	Menu button	Provides access to the settings menus.
4	Dimmer button	Dims the display.
5	Time	Displays the current time.







## 3.2.2 Display in Therapy mode



NO.	DESIGNATION	DESCRIPTION
1	Time	Displays the current time.
2	SD card symbol	The SD card is in the therapy device.
3	Info button	Provides access to the info screen with detailed information on the therapy currently in progress.
4	Alarm clock with wake-up time	Alarm clock is set. Displays the set wake-up time.
5	softSTART button	Switches the softSTART function on or off. Displays the time remaining. If the softSTART is off, the set softSTART period is displayed. If there is no softSTART button, the physician or authorized dealer has disabled this function.
6	Respiration status symbol	Indicates the current respiration status.
7	Mask status symbol with leak indicator	Indicates how well the respiratory mask is positioned.
8	Humidifier button for respiratory air humidifier	Indicates that the respiratory air humidifier is connected and switched on. Shows the set humidifier level of the respiratory air humidifier.
9	Function buttons for the respiratory air humidifier	Allow the humidifier level to be increased/ decreased.

### 3.2.3 Symbols on the display

SYMBOL	DESCRIPTION
	Bacteria filter is connected and active. If this symbol is displayed even though you are not using a bacteria filter, contact your authorized dealer.
	Air filter replacement required. (Symbol only appears if the authorized dealer has activated the reminder to change the air filter)
	Maintenance required (symbol only appears when maintenance function is active).
	USB port
	prismaCONNECT module is plugged in
<b>PSG</b>	Module prismaPSG is connected (Green symbol)
<b>PSG</b>	No connection to prismaPSG module established (Gray symbol)
	Network connection available (Green symbol)
	No network connection available (Gray symbol)
	SD card in SD card slot. Symbol flashes: Data is being saved to the SD card or read off the SD card.
	Respiratory air humidifier is connected and switched off.
	Respiratory air humidifier is connected and switched on. The set humidifier level is displayed. The choice of humidifier levels 1-7 can be limited by the physician.
	Respiratory air humidifier is connected and empty of water.

SYMBOL	DESCRIPTION
	Alarm clock is set. If no alarm clock symbol is shown: The alarm clock is off.
	Displays the respiration status: <ul style="list-style-type: none"> <li>• Arrow pointing upward: inhalation</li> <li>• Arrow pointing downward: exhalation</li> <li>• Green arrow, spontaneous respiration</li> <li>• Orange arrow, assisted breathing</li> </ul>
	Apnea
	Mask position is good, no leaks
	Mask is not well positioned, considerable leaks, the efficacy of the therapy is not guaranteed
	Indicates the diameter of the hose in mm.
	Indicates which menu level you are currently in: The more green dots, the deeper you are in the menu structure.
Alarm window	
	Low-priority alarm triggered.
	Alarm paused for 2 minutes.
	Indicates that the acoustic signal for an alarm can be muted (Black symbol)
	Acoustic signal for alarm is muted (Orange symbol)

### 3.3 Accessories

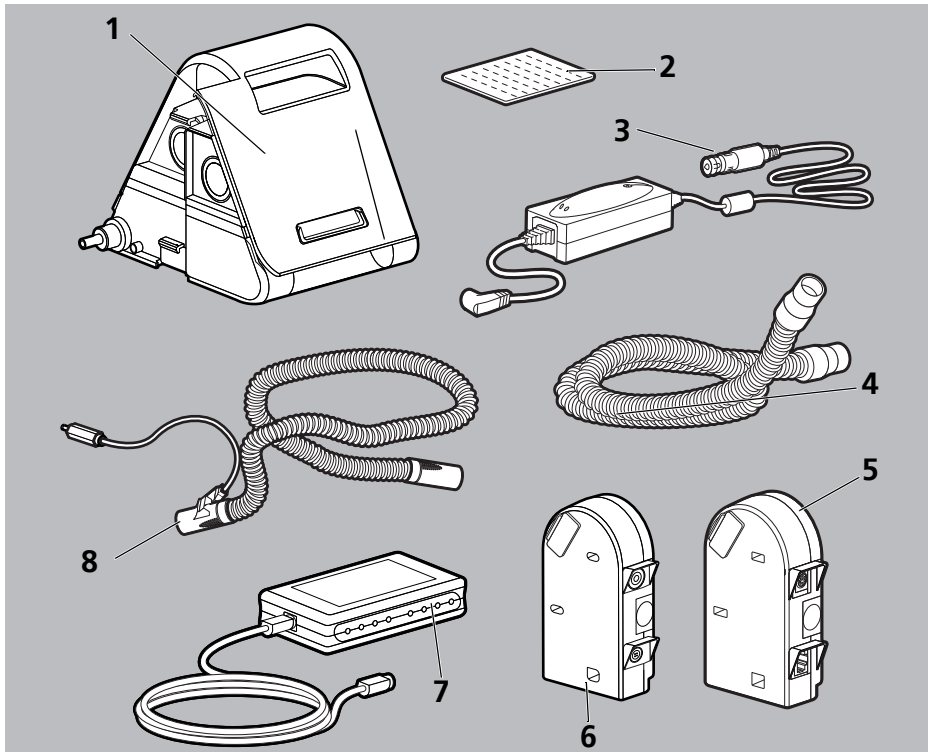

NO.	DESIGNATION	DESCRIPTION
1	Respiratory air humidifier	Humidifies the respiratory air
2	Pollen filter	Filters the suctioned respiratory air and prevents the ingress of fine dust particles, pollen and fungal spores.
3	Inverter	Enables operation of the device via a DC power socket (12 V/24 V)
4	Respiratory hose with 15 mm diameter	Connects the therapy device to the respiratory mask.
5	Communication module	Creates a connection between the therapy device and a PC or the PSG module
6	SpO <sub>2</sub> and nurse call module	Connects the therapy device with a call system and acquires SPO <sub>2</sub> and pulse frequency data.
7	PSG module	Converts digital signals from the therapy device into analog data. Is used in sleep laboratories.
8	Heatable hose	Avoids condensation in the respiration hose.

## 4 Preparation

### 4.1 Setting up the therapy device

---

#### **NOTICE**

##### ***Material damage due to overheating!***

Temperatures which are too high can cause the therapy device to overheat and damage the device.

- ⇒ The therapy device and power supply unit must not be covered with textiles (e.g., bedclothes).
  - ⇒ Do not operate the therapy device close to heating systems.
  - ⇒ Do not expose the therapy device to direct sunlight.
  - ⇒ Do not operate the therapy device in the transport bag.
- 
1. Place the therapy device on a flat surface (e.g., a bedside table).
  2. Leave the suction area of the therapy device uncovered.
  3. Keep the power plug and power socket accessible at all times.
  4. Pull the protective foil off the device.

### 4.2 Connecting up the power supply

---

#### **WARNING**

##### ***Risk of injury due to electric shock when connecting an incorrect power supply unit to the line power!***

The power supply unit contains a safety device to prevent electric shock. The use of a non-original power supply unit may result in injury to the user and the patient.

- ⇒ Only operate the device on line power using the power supply unit recommended by the manufacturer.
-

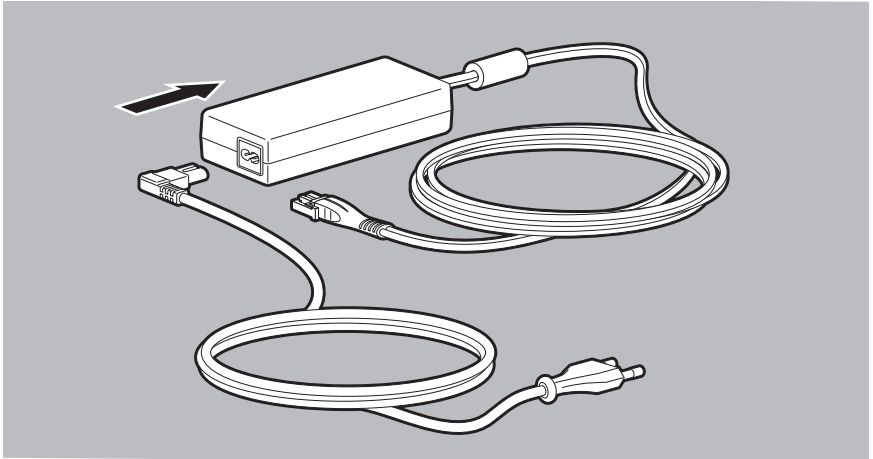

1. Connect the power supply cable with the power supply unit.

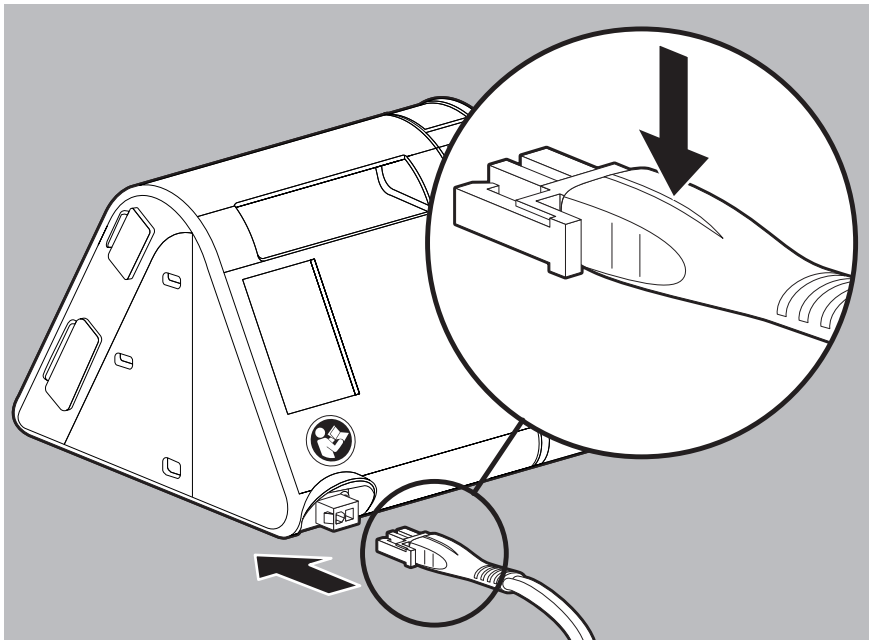

2. Insert the free connector of the power supply unit's connection cable into the power supply port on the therapy device. When doing so, pay attention to the alignment of the connector.

- i** If you want to operate the therapy device at 12 V or 24 V, connect the optionally available inverter WM 24616 (12 V) or WM 24617 (24 V) to the device.
- 3. Plug the free end of the power supply cable in the power socket.  
The power supply unit adjusts to the line voltage (110 V or 240 V) automatically.  
The LED on the power supply unit lights up green.
- i** If you want to disconnect the therapy device from the power supply, press the clip on the connector and pull the connector out.  
Do not pull on the power supply cable.

#### 4.2.1 Connecting up the respiration hose

##### **⚠ WARNING**

##### ***Risk of injury due to contaminated or infected patient hose system!***

A patient hose system contaminated or infected due to lack of or incorrectly performed hygienic preparation procedures can pass contamination or infection on to the next patient and cause injuries.

- ⇒ Do not reprepare disposable hose systems.
- ⇒ Use a bacteria filter
- ⇒ Hygienically prepare reusable hose systems correctly (see "7.4 Hygienic preparation of the respiration hose", page 45).

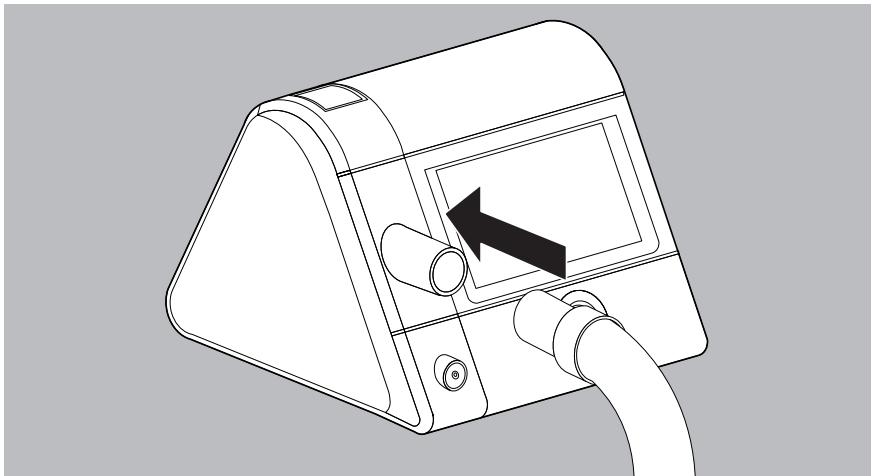

1. Connect the respiration hose to the device outlet.

 **CAUTION**
***Risk of asphyxia when using full face masks without exhalation system!***

When using full face masks without an integrated exhalation system, the CO<sub>2</sub> concentration can increase to critical values and endanger the patient.

- ⇒ Use full face masks with an external exhalation system if there is no exhalation system integrated.
  - ⇒ Observe the instructions for use of the exhalation system.
- 
2. If not integrated: Insert the external exhalation system between the respiratory mask and the respiration hose (see instructions for use of the respiratory mask and the exhalation system).
- 

 **CAUTION**
***Risk of injury due to incorrectly positioned respiration hose!***

An incorrectly positioned respiration hose can injure the patient.

- ⇒ Never place the respiration hose around the neck.
  - ⇒ Do not use any small parts to fix the respiration hose in position as they might be accidentally swallowed.
  - ⇒ Do not squash the respiration hose.
- 

3. Connect the mask with the respiration hose.









Correct positioning and alignment of the mask on the patient's face is critical for consistent operation of the device.

- 4. Check whether the hose diameter used is set in the therapy device (see "6.2 Setting accessories parameters", page 39).
- 5. Put on the respiratory mask (see instructions for use of the respiratory mask).
- 6. Start the therapy (see "5.4 Starting the therapy", page 25).
- 7. Perform a mask test to check the positioning of the mask (see "5.6 Performing a mask test", page 27).

## 5 Operation

### 5.1 Navigating the menu

You configure all the settings in the menu via the display. Press the required field directly on the display.

BUTTON	FUNCTION
	Go back a screen
	Go forward a screen
	Select values: <ul style="list-style-type: none"> <li>If the parameter can have exactly 2 possible values (e.g., on/off): Press the button. The value changes to the other one.</li> <li>If the parameter can have a range of different values, press the button and select the value from the overview.</li> </ul>
	Increase or decrease value
	Confirm value
	Reject value
	Go back to start screen (Standby or Therapy mode)

### 5.2 Switching on the therapy device

#### 5.2.1 Switching on the therapy device for the first time

Before the first therapy is performed, the therapy device must be configured. If your authorized dealer has not done so already, configure the following settings.

#### **NOTICE**

#### **Material damage if power supply is interrupted during configuration!**

If the power supply is interrupted prematurely, the configuration will not be performed correctly.

- ⇒ Leave the therapy device connected to the power supply throughout the configuration.
- ⇒ Only disconnect the power supply once the **Configuration successful** message has appeared.

1. Connect up the power supply (see "4.2 Connecting up the power supply", page 19).
2. Select your preferred language.

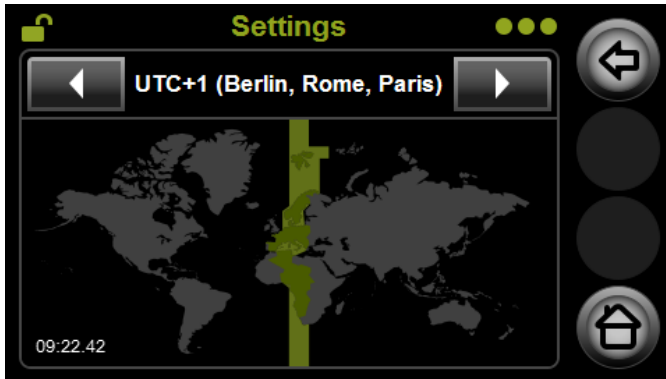

3. Select your time zone with the arrow keys ◀ and ▶.

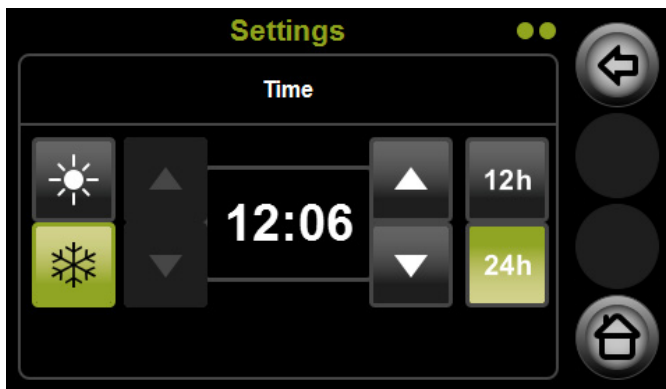

4. Set the time:
  - Select daylight saving time ☀️ or standard time ❄️. Click on the symbol with the gray background to select it. The background turns green when the setting is activated.
  - Use the arrow keys on the right to set the minutes.
  - Select the clock version: 24 h (0-24) or 12 h (0-12)
5. Confirm the set time with the  button.



If you have received an SD card from your authorized dealer with the configuration, please insert the SD card in the therapy device (see "5.11.1 Inserting the SD card", page 35). The settings are then automatically transferred to the therapy device.

## 5.2.2 Switching the therapy device on each time

The therapy device can assume 3 different modes:

- **Standby** mode (no therapy in progress)
  - **Therapy** mode (therapy in progress)
  - **Energy saving** mode (display is off to save energy during the day)
1. To switch the therapy device to **Standby** mode, connect up the power supply (see "4.2 Connecting up the power supply", page 19).
  2. If the display remains off, the therapy device is in **Energy saving** mode: Press the On/Off button .

 After being switched on, the device displays the patient-related operating hours for 30 seconds.

## 5.3 Switching off the therapy device

1. To save energy during the day, keep the On/Off button  depressed for 3 seconds.

**or**

If the automatic energy saving function is activated: The therapy device switches to the **Energy saving** mode automatically 15 minutes after the user has performed the last action.

 The automatic energy saving function can be activated in the menu *Main menu | Device | Energy saving* (see "6.4 Setting device parameters", page 40).

## 5.4 Starting the therapy

1. Connect the components (see "6.1 Setting comfort parameters", page 38).
2. Connect the power supply (see "4.2 Connecting up the power supply", page 19).
3. If the display remains off, the therapy device is in **Energy saving** mode: Press the On/Off button . The therapy device switches to the **Standby** mode.

4. Press the On/Off button .

**or**

If the autoSTART-STOP function is active: Breathe into the mask.

 You can activate the autoSTART-STOP function in the menu *Main menu | Comfort | autoSTART-STOP* (see "6.1 Setting comfort parameters", page 38).

The therapy starts.

The start screen is shown in the **Therapy** mode.

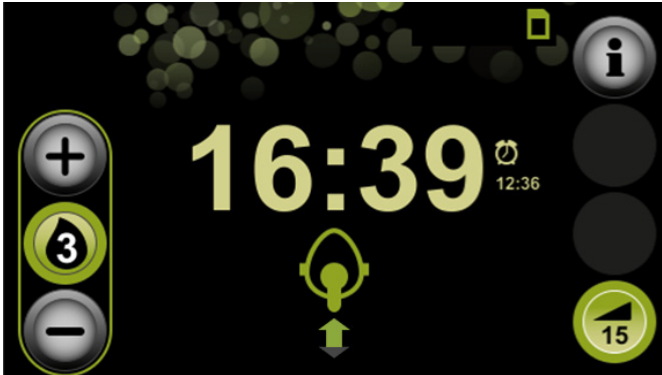

If you want to view detailed information on your therapy: Press the info button .

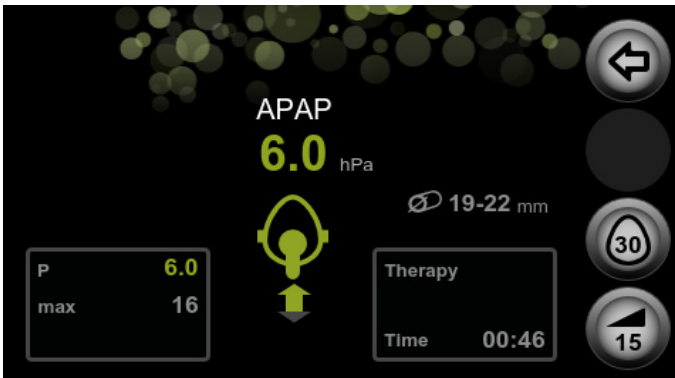

 To allow you to sleep undisturbed, the display automatically turns dark after 30 seconds. The therapy continues normally. As soon as you press the display, the start screen is shown in the **Therapy** mode again.

## 5.5 Ending the therapy

1. Press the On/Off button .

**or**

If the autoSTART-STOP function is active: Remove the respiratory mask.  
The therapy is automatically ended after 5 seconds.

 You can activate the autoSTART-STOP function in the menu Main menu | Comfort | autoSTART-STOP (see "6.1 Setting comfort parameters", page 38).

The therapy data for the last therapy session is shown briefly if the physician or authorized dealer has enabled this function. In all other cases, the usage time is displayed.





The more green checks are shown (max. 3), the better the result.



- i** If you want to end the therapy prematurely during the night, you can use the dimmer button on the start screen  to turn the display dark and sleep undisturbed. The therapy device is still supplied with power and the alarm function remains activated. As soon as you touch the display, the start screen is shown in the **Standby** mode again.

## 5.6 Performing a mask test

The therapy device is equipped with a mask test function. To minimize the risk of leaks and test the correct positioning of the mask even at higher pressures, you can perform a mask test before starting the therapy.

### Requirement

- The mask test function has been enabled by the physician or authorized dealer.
  - The therapy device is in **Therapy** mode.
1. Press the  button.
  2. To start the mask test, press the mask test  button. The remaining time in seconds is shown.
  3. Check the seal of the mask against what is shown on the display:

SYMBOL	MEANING
	Mask position is good, no leaks
	Mask is not well positioned, considerable leaks, the efficacy of the therapy is not guaranteed

4. If necessary: Adjust the mask straps.

5. Wait until the therapy device automatically ends the mask test after 30 seconds.

**or**

To end the mask test prematurely, press the mask test button .



If you switch the softSTART on during the mask test, the mask test is automatically switched off.

## 5.7 Switching softSTART on/off

The softSTART function makes it easier to get used to the ventilation pressure when falling asleep. You can set a pressure different to the prescribed therapy pressure. When switched on, the therapy device sets this softSTART pressure. The pressure then increases slowly within the specified period or drops after the specified period (maximum 45 minutes) to the therapy level.

This function is suitable for patients who find a high or low pressure uncomfortable when awake and cannot fall asleep.

*Requirement*

- The softSTART function has been enabled by the physician or authorized dealer.
- A softSTART pressure is set (see "6.1 Setting comfort parameters", page 38).

1. Start the therapy (see "5.4 Starting the therapy", page 25).
2. If softSTART was activated during the last therapy: softSTART starts automatically when the therapy starts.

**or**

Press the softSTART button  to switch softSTART on.  
The remaining time in minutes is shown.

3. Press the softSTART button  to switch softSTART off.  
The set softSTART time in minutes is shown.



When running, a mask test will only interrupt softSTART and it will be restarted after the mask test.

## 5.8 Setting the respiratory air humidifier

### 5.8.1 Switching on the respiratory air humidifier

The respiratory air humidifier switches on automatically when you start the therapy (see "5.4 Starting the therapy", page 25).

You can also preheat the humidifier to ensure that the water in the respiratory air humidifier has already reached the required temperature by the start of the therapy. Please note that the respiratory air humidifier will switch itself off again automatically after 30 minutes of preheating.

*Requirement*

- The therapy device is in **Standby** mode.
  - The respiratory air humidifier is filled with water.
  - The respiratory air humidifier is connected.
- The humidifier button is gray .

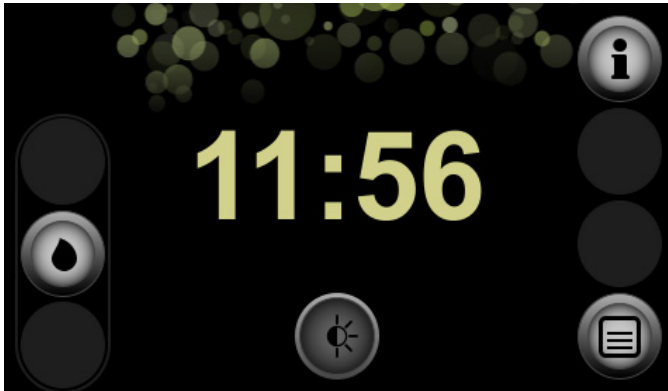

1. Press the humidifier button .

### 5.8.2 Switching off the respiratory air humidifier

The respiratory air humidifier switches off automatically when you end the therapy (see "5.5 Ending the therapy", page 26).



You can also switch the respiratory air humidifier off during the therapy.

*Requirement*

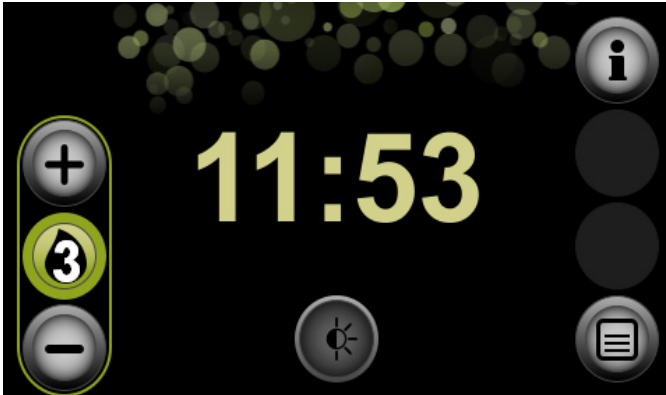
- The therapy device is in the Therapy mode.
  - The respiratory air humidifier is connected to the **therapy** device.
  - The respiratory air humidifier is switched on.
- The humidifier button is green .



1. Press the humidifier button .

 If there is no more water left in the respiratory air humidifier, the respiratory air humidifier switches off automatically. The humidifier button is orange .



### 5.8.3 Setting the humidifier level

#### Requirement

- The therapy device is in the **Standby** or **Therapy** mode.
- The respiratory air humidifier is filled with water.
- The respiratory air humidifier is connected to the therapy device.
- The respiratory air humidifier is switched on.

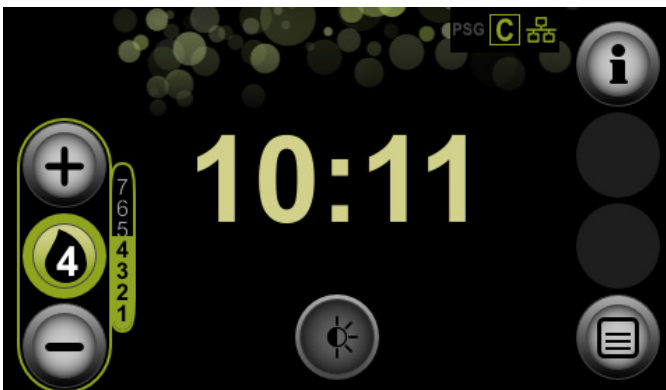
The humidifier button is green and the humidifier level is shown .



1. The  and  buttons can be used to increase or decrease the humidifier level.

- i** There are seven humidifier levels available (1-7). The level which is suitable for you depends on the room temperature and the humidity. The standard setting is level 4. If you wake up with dry airways, the heating is set too low. If there is condensation in the respiration hose in the morning, the heating is too high. The choice of humidifier levels 1-7 can be limited by the physician. To reduce condensation in the respiration hose, we recommend using a hose heating system.

## 5.9 Setting the alarm



### 5.9.1 Setting the wake-up time and switching on the alarm

#### *Requirement*

The therapy device is in **Standby** mode.

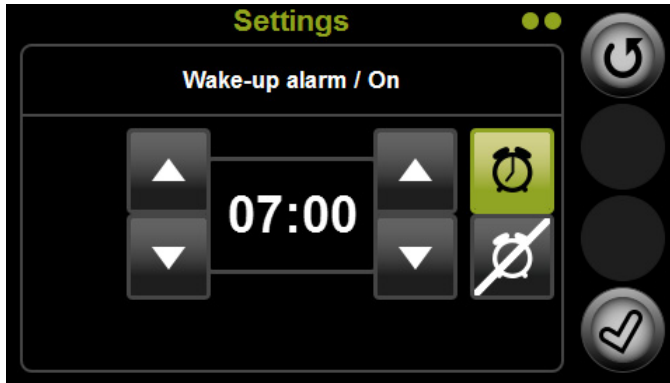
1. Press the time display on the start screen.  
**or**  
Press the menu button .
2. Press the **Time**  field.
3. Press the **Wake-up time** field.
4. To switch the alarm on, press the alarm button .



5. To set the wake-up time, use the left arrow keys to select the hours and the right arrow keys to select the minutes.
6. Confirm the settings with the  button.
7. To return to the start screen, press the Home button .

## 5.9.2 Switching off the alarm





### Requirement

The alarm is ringing.

1. To snooze the alarm for 5 minutes, press the **Pause** field.
2. To turn the alarm off for today, press the **Off** field.  
The alarm will go off the following day again at the set wake-up time.

## 5.9.3 Deactivating the alarm

### Requirement

- The therapy device is in **Standby** mode.
  - The alarm is switched on (see "5.9.1 Setting the wake-up time and switching on the alarm", page 31).
1. Press the time display on the start screen.  
**or**  
Press the menu button .
  2. Press the **Time**  field.
  3. Press the **Wake-up time** field.
  4. Press the alarm button .
  5. Confirm the setting with the  button.
  6. To return to the start screen, press the Home button .

## 5.10 Viewing therapy data and device information

In the info menu you can view information about the therapy (usage time, mask fit, therapy quality) within a selectable period of time and general information about the device and network.

### Requirement

The therapy device is in **Standby** mode.

1. Press the info button .

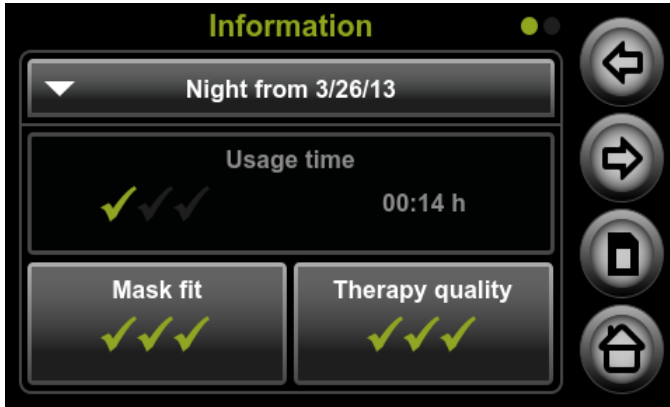

2. If necessary: To view therapy data from a night other than the previous night, select the desired date in the list .

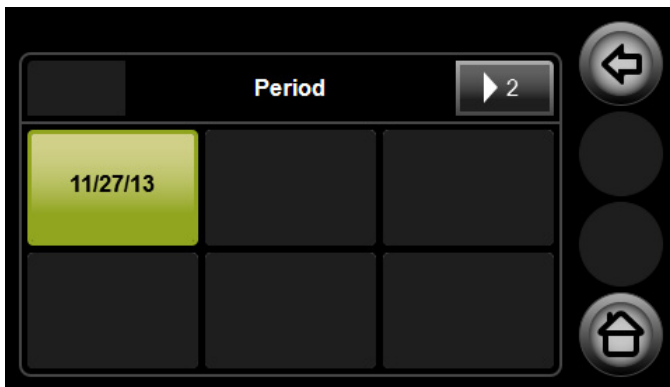



3. If necessary: To view a longer period of time, navigate to the second screen .

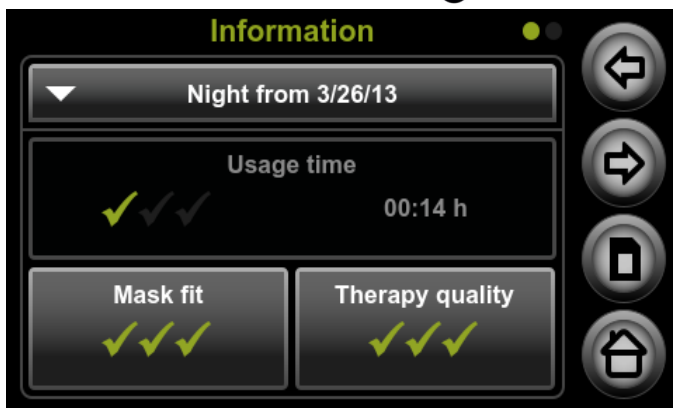

4. Select the required period.
5. To go back a screen, press the arrow key .



6. If required, save all the data to the SD card (see " [Saving the therapy data manually](#)", page 36).
7. To view the device information, navigate to the next screen using the arrow keys  and .
8. To exit the info menu, press the Home button .

## 5.11 Using the SD card

An SD card is not necessarily required for the operation of the therapy device. The therapy data and settings are stored internally in the device.

### **NOTICE**

#### **Loss of data due to incorrect SD card!**

SD cards not purchased from the manufacturer may have reduced functionality or result in the loss of data.

⇒ Only use SD cards from brand manufacturers which comply with the specifications (see "13.1 Technical Data", page 52).

Do not use the SD card for third-party files.

### 5.11.1 Inserting the SD card

#### *Requirement*

The therapy device is in **Standby** mode.

1. Open the SD card slot cover.

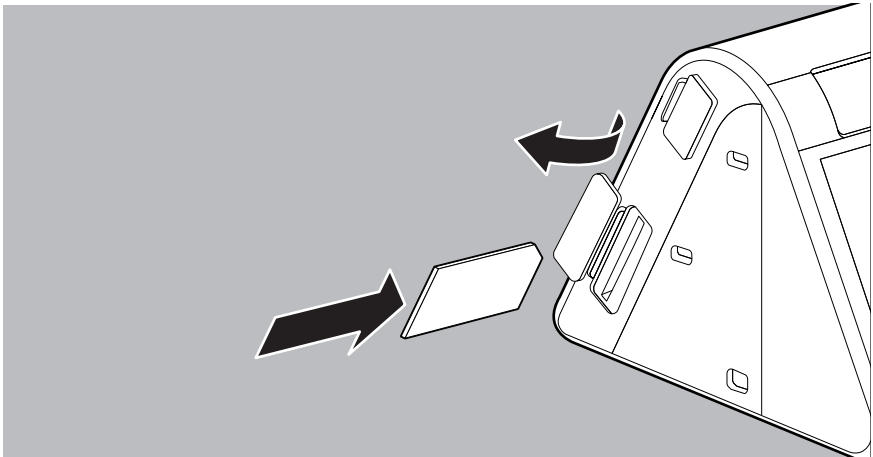

2. Slide the SD card into the SD card slot until it audibly clicks into place.  
Note: The beveled corner of the SD card must be at the top and facing the device during insertion.
3. Close the SD card slot cover.

## 5.11.2 Saving therapy data to the SD card

### NOTICE

#### **Data loss in case of power loss!**

Data may be lost if the therapy device is disconnected from the power supply during the saving process.

⇒ Keep the therapy device connected to the power supply during the saving process (SD card symbol  flashes).

### Autosave

The therapy device saves the therapy data automatically in the following events:

- Each time you end a therapy.
- Each time you insert an SD card. Only insert an SD card when the device is in **Standby** mode.
- When the therapy device is reconnected to the power supply after a saving process is interrupted.

### Saving the therapy data manually

#### Requirement

- The SD card is inserted in the therapy device (see "5.11.1 Inserting the SD card", page 35).
  - The info menu with the therapy data for the requested period is open (see "5.10 Viewing therapy data and device information", page 32).
1. To save all the therapy data to the SD card, press the SD card button .
  2. Press the **Save all data** field and confirm with the **OK** field.

## 5.11.3 Removing the SD card

#### Requirement

- The therapy device is in the Standby mode.
  - The SD card symbol  is no longer flashing.
1. Open the SD card slot cover.
  2. Briefly press in the SD card.  
The SD card is ejected slightly.

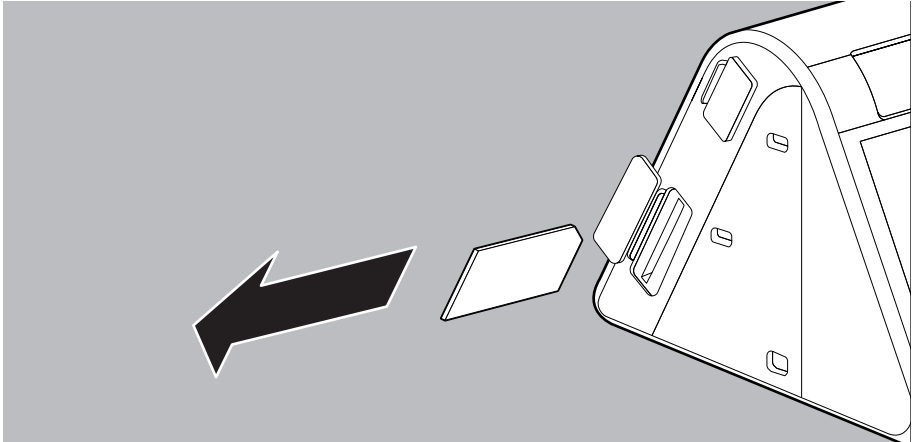

3. Remove the SD card.
4. Close the cover of the SD card slot.

#### 5.11.4 Setting the device with the SD card

You can set the device with the help of an SD card provided by your physician or authorized dealer.

##### *Requirement*

The therapy device is in the Standby mode.

1. Insert the SD card with the saved device settings (see "[5.11.1 Inserting the SD card](#)", page 35).  
 The message **Configuration via SD card was successful** appears on the display. You can continue the therapy with the new settings.  
 If the new settings for your device were not suitable or could not be read, the message **Configuration via SD card has failed** appears on the display. Contact your authorized dealer to obtain new settings.

## 6 Settings in the menu



You can configure settings for the comfort, accessories, and time parameters in the settings menu when the therapy device is in **Standby** mode.

### 6.1 Setting comfort parameters

Comfort parameters facilitate handling of the therapy device and components for the patient and ensure a comfortable therapy.

#### Requirement

The therapy device is in **Standby** mode.

1. Press the menu button .
2. Press the **Comfort**  field.
3. Configure the desired settings and confirm.

PARAMETER	POSSIBLE VALUES	DESCRIPTION
autoSTART-STOP	On Off	Here you can activate/deactivate the automatic on/off function autoSTART-STOP. If the automatic on/off function is activated, you can switch the therapy device on with a breath. If there is no pressure for 5 seconds (e.g., because the mask has been removed), the therapy device switches itself off again automatically.
Mask test pressure	8 cmH <sub>2</sub> O- 20 cmH <sub>2</sub> O (depending on the therapy pressure currently set)	Here you can set the pressure at which the mask test is performed (see "5.6 Performing a mask test", page 27). Leaks due to a poorly sitting mask often only occur at higher pressures.
softSTART Pressure	Intervals of 0.5 in the range prescribed by the physician or authorized dealer (e.g., at least 4 cmH <sub>2</sub> O to 8 cmH <sub>2</sub> O).	The softSTART function makes it easier to get used to the ventilation pressure when falling asleep. You can set the desired softSTART pressure here. If it is not possible to select this function, it must be enabled by your physician or authorized dealer.
softSTART time	Intervals of 5 minutes in the range prescribed by the physician or authorized dealer (e.g., 5 mins to max. 45 mins).	Here you can set the period of time during which the ventilation pressure increases until it reaches the therapy pressure when the softSTART function is used. If it is not possible to select this function, it must be enabled by your physician or authorized dealer.

PARAMETER	POSSIBLE VALUES	DESCRIPTION
softPAP	Off 1 2 3	<p>Settings 1 and 2 of the softPAP breathing relief function are intended for patients who find exhaling against high pressure uncomfortable. The breathing relief function reduces the pressure early during the transition to expiration, allowing you to breathe out more easily.</p> <p>Setting 3 is suitable for patients who experience respiratory distress with a low pressure setting. The pressure is raised slightly during inspiration.</p> <p>You can select the setting for the softPAP breathing relief here or deactivate it if you do not wish to use the function anymore.</p> <ul style="list-style-type: none"> <li>• Setting 1: Low breathing relief</li> <li>• Setting 2: Normal breathing relief</li> <li>• Setting 3: Breathing relief with inhalation assistance</li> </ul> <p>This function is only available in CPAP and APAP mode. If it is not possible to select this function in one of these modes, it must be enabled by your physician or authorized dealer.</p>

## 6.2 Setting accessories parameters

The accessories parameters are used to set the use of the accessories.

### *Requirement*

The therapy device is in **Standby** mode.

1. Press the menu button .
2. Press the **Accessories**  field.
3. Configure the desired settings and confirm.

PARAMETER	POSSIBLE VALUES	DESCRIPTION
Tube type	15 mm 19-22 mm	Here you select the diameter of the hose type used. If it is not possible to select this function, it must be enabled by your physician or authorized dealer.
Air filter Change	Changed Cancel	Here you specify whether you have changed the air filter. For this function, the authorized dealer must have activated the air filter reminder.



### 6.3 Setting time parameters

In the time parameters you set the minutes of the current time, the time zone, and the desired wake-up time.

#### Requirement

The therapy device is in **Standby** mode.

1. Press the menu button .
2. Press the **Time**  field.
3. Configure the desired settings and confirm.

PARAMETER	POSSIBLE VALUES	DESCRIPTION
Time	 	<p>Here you can set the current time:</p> <ul style="list-style-type: none"> <li>• Select daylight saving time or standard time. The green background of the symbol shows that this setting is active.</li> <li>• Use the arrow keys on the right to set the minutes.</li> <li>• To set the hours: Select another time zone.</li> <li>• Select the clock version: 24 hours (0-24) 12 hours (0-12)</li> </ul> <p>You can reset the time to the end of the last therapy at most.</p>
Time zone	UTC -12 to UTC +12	Here you select the desired time zone.
Wake-up time	00:00 -12:00 / 23:59	Here you set the time at which you want to be woken up (see " <a href="#">5.9.1 Setting the wake-up time and switching on the alarm</a> ", page 31).

### 6.4 Setting device parameters

You can use the device parameters to set the brightness of the display and the volume of the acoustic signals among other things as you wish.

#### Requirement

The therapy device is in **Standby** mode.

1. Press the menu button .
2. Press the **Device**  field.
3. Configure the desired settings and confirm.

PARAMETER	POSSIBLE VALUES	DESCRIPTION
Display brightness	1 2 3	Here you can set the brightness of the display. <ul style="list-style-type: none"> <li>• Level 1: Dark</li> <li>• Level 2: Normal</li> <li>• Level 3: Bright</li> </ul>
Leakage alert	Off On	Here you can set whether an alarm should be triggered in case of a leak. This allows you to change the position of your mask at night. By doing so you avoid side effects or a reduced therapy quality due to severe leaks. If it is not possible to select this function, it must be enabled by your physician or authorized dealer.
Energy saving	Off On	Here you can activate or deactivate whether the therapy device automatically switches to <b>Energy saving</b> mode 15 minutes after the therapy has finished. You save electricity if the therapy device is in <b>Energy saving</b> mode during the day.
Key tone volume	Off 1 2 3	Here you can set the volume of the acoustic signal for every time a key is pressed or switch the signal off. <ul style="list-style-type: none"> <li>• Level 1: Quiet</li> <li>• Level 2: Normal</li> <li>• Level 3: Loud</li> </ul>
Alarm volume	1 2 3	Here you can set the volume of the alarms. <ul style="list-style-type: none"> <li>• Level 1: Quiet</li> <li>• Level 2: Normal</li> <li>• Level 3: Loud</li> </ul>
Alarm clock volume	Off 1 2 3	Here you can set the volume of the alarm. <ul style="list-style-type: none"> <li>• Level 1: Quiet</li> <li>• Level 2: Normal</li> <li>• Level 3: Loud</li> </ul>

## 7 Hygienic preparation

### 7.1 General information

- **This product may contain disposable items. Disposable items are intended to be used only once.** Use these items only once and do **not** reprocess them. Reprocessing disposable items may impair the functionality and safety of the product and lead to unforeseeable reactions as a result of aging, embrittlement, wear, thermal load, the effects of chemical processes, etc.
- Wear suitable protective equipment for disinfection work.
- Please refer to the instructions for use supplied with the disinfectant used.
- Also observe the respective instructions for use for the therapy device, the components, and the accessories.
- The therapy device is suitable for subsequent use on further patients following hygienic preparation by the authorized dealer.

### 7.2 Cleaning intervals

INTERVAL	ACTION
Weekly	Clean the therapy device ( <a href="#">see "7.3 Hygienic preparation of the therapy device", page 43</a> )
	Clean the respiration hose ( <a href="#">see "7.4 Hygienic preparation of the respiration hose", page 45</a> )
	Clean the respiratory air humidifier In clinical areas: Disinfect the respiratory air humidifier
Monthly	Clean the air filter ( <a href="#">see "7.3.1 Cleaning the air filter (gray filter)", page 44</a> )
	If present: Replace the (optional) pollen filter ( <a href="#">see "7.3.2 Replacing the optional pollen filter (white filter)", page 44</a> )
Every 6 months	Replace the air filter
Annually	Replace the respiration hose
As necessary	Descalc the respiratory air humidifier. In clinical areas: Disinfect the respiration hose. For hygienic reasons: Replace the housing components of the respiratory air humidifier if they are in poor condition (e.g., if cracks appear).
When changing patients	If the therapy device or respiratory air humidifier has been used without a bacteria filter: Have professional hygienic preparation performed before using the device again. Send the therapy device to your authorized dealer.

## 7.3 Hygienic preparation of the therapy device

### CAUTION

#### **Risk of injury from electric shock!**

Any liquids entering the device can cause a short circuit, injure the user, and damage the therapy device.

- ⇒ Disconnect the therapy device from the power supply before starting the hygienic preparation.
- ⇒ Do not immerse the therapy device and the components in liquids.
- ⇒ Do not pour liquids over the therapy device and the components.

1. Switch off the therapy device (see "5.3 Switching off the therapy device", page 25).
2. Disconnect the therapy device from the power supply.
3. If present: Remove the respiratory air humidifier.
4. Prepare the therapy device and the components hygienically in accordance with the following table:

PART	CLEANING	DISINFECTION	STERILIZATION
Housing	Wipe with a damp cloth using water or mild soap	Wipe disinfection (Recommendation: terralin <sup>®</sup> protect or perform advanced Alcohol EP)	Not permitted
High-gloss surfaces on the housing	Wipe with a damp cloth using water or mild soap; do not use microfiber cloths		
Display	Wipe with a dry cloth: do not use water, mild soap or microfiber cloths		
Power supply unit	Wipe with a damp cloth using water or mild soap		
Power supply cable	Wipe with a damp cloth using water or mild soap		

5. If present: Connect the respiratory air humidifier to the therapy device.
6. Reconnect to power supply.
7. Perform a function check (see "8 Function check", page 46).

### 7.3.1 Cleaning the air filter (gray filter)

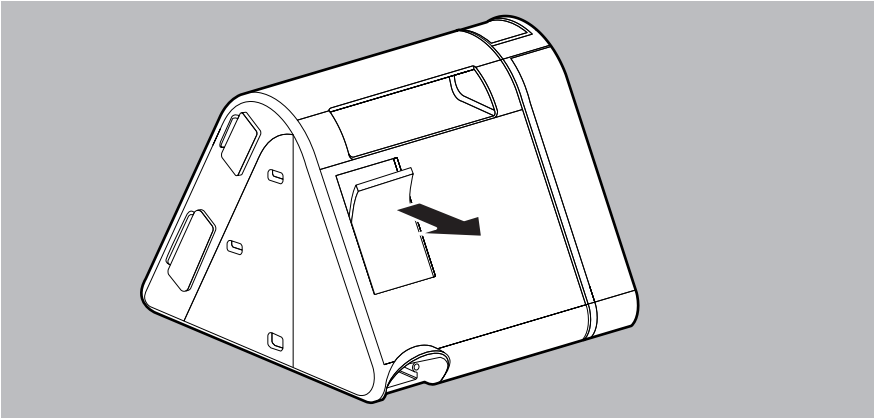

1. Remove the air filter.
2. Clean the air filter under running water.
3. Leave the air filter to dry.
4. Replace the air filter in the holding bracket.

### 7.3.2 Replacing the optional pollen filter (white filter)

1. Remove the air filter.

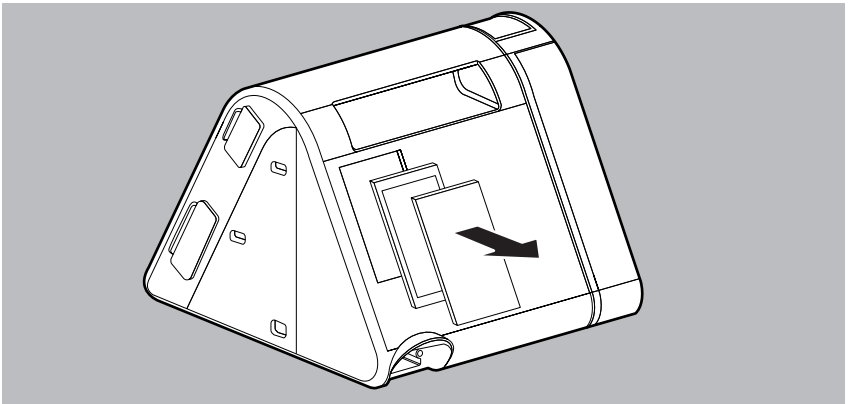

2. Remove and dispose of the pollen filter.
3. Insert the new pollen filter in the holding bracket.
4. Replace the air filter in the holding bracket.

## 7.4 Hygienic preparation of the respiration hose

### NOTICE

#### ***Damage to the device caused by ingress of liquids!***

Ingress of liquids may damage the device.

⇒ Only use the respiration hose when it is completely dry.

1. Remove the respiration hose from the therapy device.
2. Carry out hygienic preparation of the respiration hose as specified in the following table:

PART	CLEANING	DISINFECTION	STERILIZATION
Respiration hose	With warm water and washing-up liquid	Immersion disinfection (Recommendation: gigasept FF®)	Not permitted

3. Rinse respiration hose off with clean water.
4. Shake respiration hose out thoroughly.
5. Hang up the respiration hose and leave it to drip dry.
6. Dry the respiration hose.



If you use a heatable respiratory hose, please observe the instructions for use for the respiratory hose.



## 8 Function check

### 8.1 Intervals

Carry out a functional check after every hygienic preparation, after every repair, and at least every 6 months.

### 8.2 Checking the therapy device

#### *Requirement*

- The therapy device is disconnected from the patient.
  - The therapy device is connected to the power supply.
  - The therapy device is in **Standby** mode.
1. Inspect the therapy device for external damage.  
If damaged: Do not use the therapy device.
  2. Inspect the plug and cable for external damage.  
If damaged: Contact the authorized dealer and have the parts replaced.
  3. Check that the components are connected to the therapy device correctly in accordance with these instructions for use.
  4. Switch on the therapy device (see "5.2 Switching on the therapy device", page 23).
  5. If softSTART is activated: Press the softSTART button  to stop softSTART.
  6. Close the opening on the respiratory mask (e.g., using the elbow).
  7. Press the info button .
  8. Compare the pressure shown in the display with the prescribed pressure.  
If the pressure variance is  $> 1 \text{ cmH}_2\text{O}$ : Do not use the therapy device and contact the authorized dealer.





## 9 Alarms and error messages

If you are not able to clear an error message with the aid of the table below, or in the event of unexpected operation or an incident, you should have the device repaired by the manufacturer or your authorized dealer. To avoid serious damage, do not continue using the device.

### 9.1 Alarms

Alarms can be categorized into three priority levels (low, medium, high). This device only has low-priority alarms, which are indicated by the symbol .

#### 9.1.1 Alarm messages

ALARM MESSAGE	CAUSE	REMEDY
 Pressure build-up not possible! Please connect the mask and hose.	No respiration hose and/or mask connected.	Connect the mask and respiration hose correctly (see "4.2.1 Connecting up the respiration hose", page 21).
 High Leak! Please check the mask fit.	Mask has slipped or is not tight.	Reposition mask. If the mask is faulty, exchange it.
 Apnea! Please check the ventilation settings and the course of the respiration hose.	The respiratory volume output by the device is lower than the target value.	Check that the respiration hose is neither blocked nor kinked. Reposition the mask and breathe through it. If the alarm continues to show: Have the settings checked by the attending physician.
 Low tidal volume! Please check the ventilation settings and the course of the respiration hose.	The respiratory volume output by the device is lower than the target value.	Check that the respiration hose is neither blocked nor kinked. Reposition the mask and breathe through it. If the alarm continues to show: Have the settings checked by the attending physician.

ALARM MESSAGE	CAUSE	REMEDY
 Low minute volume! Please check the ventilation settings and the course of the respiration hose.	The respiratory volume output by the device is lower than the target value.	Check that the respiration hose is neither blocked nor kinked. Reposition the mask and breathe through it. If the alarm continues to show: Have the settings checked by the attending physician.

### 9.1.2 Muting the alarm

If an alarm sounds, you can mute the audible alarm for 2 minutes.

#### *Requirement*

An alarm has been triggered.

1. Press the mute symbol .

The alarm is muted for 2 minutes. The symbol turns orange. After 2 minutes, the audible alarm sounds again.



If your physician has activated this function, you can also deactivate the **High Leak** alarm permanently (see "6.4 Setting device parameters", page 40).

### 9.1.3 Pausing the alarm

If an alarm sounds, you can pause the alarm for 2 minutes to operate the device normally in the meantime.

#### *Requirement*

The **Apnea**, **Low minute volume**, or **Low tidal volume alarm** has been triggered.

1. Press the **PAUSE** field.

The alarm is paused for 2 minutes. The  symbol appears in the status line. After 2 minutes, the audible alarm sounds again.



If your physician has activated this function, you can also deactivate the **High Leak** alarm permanently (see "6.4 Setting device parameters", page 40).

## 9.2 Faults in the therapy device

FAULT	CAUSE	REMEDY
No running noise, no information on the display.	No power supply.	Check that the power supply cable is connected properly. Check the function of the socket-outlet.
	SD card defective.	Remove the SD card (see 5.11.3, p. 36), disconnect the device from the power supply, reconnect it and switch it back on. If the device can be switched on: Replace SD card. If the error persists: Contact your authorized dealer.
It is not possible to start therapy with a breath.	autoSTART-STOP function is not active.	Activate the autoSTART-STOP function (see 6.1, p. 38).
The therapy device does not switch off after approx. 5 seconds when the mask is removed.	autoSTART-STOP function can be impaired by accessories with a high level of resistance.	Contact your authorized dealer.
softSTART cannot be switched on.	softSTART function is disabled.	Ask the physician whether the function can be enabled.
Therapy device does not reach the lower pressure limit.	Air filter is dirty.	Clean the air filter. If necessary: Replace filter (see "7 Hygienic preparation", page 42).
	Respiratory mask is leaking.	Adjust the headband until the mask fits tightly. If necessary, replace defective mask.

### 9.3 Display messages

If the message **Error (xxx): Please follow the instructions in the Instructions for use** appears on the display, locate the displayed error code in the table. Rectify the error as described.

ERROR CODE	CAUSE	REMEDY
(108)	The therapy device does not display the set time.	Contact the authorized dealer and have the device repaired.
(204)	The respiratory air humidifier is not working correctly.	Remove the respiratory air humidifier from the therapy device and connect it again. If the message is still shown, contact the authorized dealer and have the device and the respiratory air humidifier checked.
(205)	The power supply voltage is not within the permitted range.	Check whether the correct power supply unit is connected (WM 29657). Contact the authorized dealer and have the device and power supply unit checked.
(206)	Error in the prismaCONNECT module.	Remove and reconnect the prismaCONNECT module. If the fault persists: Contact the authorized dealer and have the prismaCONNECT module replaced.
(702)	Device output is blocked. / Water in therapy device.	Ensure that the respiration hose and device output are not blocked. If the fault persists: <ul style="list-style-type: none"> <li>• Check whether there is water in the device. To do so, remove the respiratory air humidifier and side part and tilt the device with the open side facing downward.</li> <li>• If water comes out: Wait until all the water has escaped.</li> <li>• Allow the device to dry until the message is no longer displayed. In future, do not transport the device with water in the respiratory air humidifier.</li> <li>• If water collects in the respiration hose: Reduce the humidifier level to avoid condensation.</li> </ul>
All other error codes	Problems with the electronics	Disconnect the therapy device from the power supply and reconnect it (see 4.2, p. 19). If the message is still shown, contact the authorized dealer and have the device and the respiratory air humidifier checked.

## 10 Maintenance

The therapy device is designed to have a useful service life of 6 years.

If the therapy device is used as intended in accordance with the instructions for use, it does not require any maintenance within this period.

If the therapy device is used beyond this period, we recommend having it checked by an authorized dealer.

If you identify faulty parts during the function check (see "8 Function check", page 46), contact your authorized dealer.

## 11 Transport and storage

Store and transport the device under the specified ambient conditions (see "13.1 Technical Data", page 52).

## 12 Disposal



Do not dispose of the product in the household waste. Consult an authorized, certified electronic waste recycling company for proper disposal. You can find out their address from your environmental officer or from your local council. The device packaging (cardboard box and inserts) can be disposed of as waste paper.

## 13 Appendix

### 13.1 Technical Data

#### 13.1.1 Technical data of therapy device

SPECIFICATION	THERAPY DEVICE
Product class according to 93/42/EEC	Ila
Dimensions W x H x D in cm	17 x 13.5 x 18
Weight	1.4 kg
Temperature range - Operation - Transport and storage	+5°C to +40°C -25°C to +70°C
Permissible humidity during operation, transport and storage	Rel. humidity 15% to 93%, non-condensing
Air pressure range	700 cmH <sub>2</sub> O to 1060 cmH <sub>2</sub> O corresponds to a height of 3000 m above sea level adapts automatically to altitude
Connection diameter of respiration hose in mm	19.5 (to fit standard cone)
Electrical output	Max. 40 VA
System interface	12 V DC Max. 10 VA
Current consumption during operation (Therapy) 240 V AC 100 V AC	0.11 A 0.25 A
in standby mode (Standby) 240 V AC 100 V AC	0.035 A 0.022 A
Classification as per DIN EN 60601-1-11: Protection class against elec. shock	Protection class II
Degree of protection against elec. shock	Type BF
Protection against harmful ingress of water and solid particles	IP21
Classification as per IEC 60601-1: Operating mode	Continuous operation

SPECIFICATION	THERAPY DEVICE
Applied part	Respiratory mask
Average sound pressure level in operation as per ISO 80601-2-70	Approx. 26.5 dB(A) at 10 cmH <sub>2</sub> O (corresponds to a sound power level of 34.5 dB(A))
Average sound pressure level in operation as per ISO 80601-2-70 with respiratory air humidifier	Approx. 27.5 dB(A) at 10 cmH <sub>2</sub> O (corresponds to a sound power level of 35.5 dB(A))
Sound pressure level of alarm message	At least 58 dB(A)
Alarms (optional)	<p><b>All device types</b> Disconnection, high leak (optional)</p> <p><b>prisma30ST, prismaLAB</b> Apnea, low minute volume, low tidal volume</p>
Alarm output	Optical and acoustic
CPAP operating pressure range	4 cmH <sub>2</sub> O to 20 cmH <sub>2</sub> O
AcSV pressure range	4 cmH <sub>2</sub> O to 30 cmH <sub>2</sub> O
BiLevel pressure range	4 cmH <sub>2</sub> O to 30 cmH <sub>2</sub> O
Pressure accuracy	< 20 cmH <sub>2</sub> O: ± 0.6 cmH <sub>2</sub> O ≥ 20 cmH <sub>2</sub> O: ± 0.8 cmH <sub>2</sub> O
P Lim <sub>max</sub> (maximum pressure in case of error)	≤ 40 cmH <sub>2</sub> O
Target volume in AcSV mode	It is not possible to set a target volume for the AcSV mode. The pressure control stabilizes the volume at the respective current level.
Automatic backup frequency in AcSV and autoS/T modes	The automatic backup frequency is continuously adapted between 10 bpm and 20 bpm, depending on the filtered spontaneous rate and the relative respiratory minute volume of the patient.
softSTART can be adjusted	0; 5-45 min
softSTART pressure	min. 4 hPa
<p><b>prisma25S-C</b></p> <ul style="list-style-type: none"> <li>- Inspiratory positive airway pressure (IPAP)</li> <li>- Expiratory positive airway pressure (EPAP)</li> <li>- Relative inspiration duration Ti/Tset</li> <li>- Trigger</li> <li>- Pressure rise rate</li> <li>- Available modes</li> </ul>	<p>4 cmH<sub>2</sub>O to 25 cmH<sub>2</sub>O</p> <p>4 cmH<sub>2</sub>O to 25 cmH<sub>2</sub>O</p> <p>20% to 67%</p> <p>Auto, can be set to 3 levels</p> <p>Can be set to 3 levels</p> <p>CPAP, S</p>

SPECIFICATION	THERAPY DEVICE
<b>prisma25S</b> <ul style="list-style-type: none"> <li>- Inspiratory positive airway pressure (IPAP)</li> <li>- Expiratory positive airway pressure (EPAP)</li> <li>- Relative inspiration duration Ti/Tset</li> <li>- Trigger</li> <li>- Pressure rise rate</li> <li>- Available modes</li> </ul>	4 cmH <sub>2</sub> O to 25 cmH <sub>2</sub> O  4 cmH <sub>2</sub> O to 25 cmH <sub>2</sub> O 20% to 67% Auto, can be set to 3 levels Can be set to 3 levels CPAP, APAP, S, autoS
<b>prisma25ST</b> <ul style="list-style-type: none"> <li>- Inspiratory positive airway pressure (IPAP)</li> <li>- Expiratory positive airway pressure (EPAP)</li> <li>- Relative inspiration duration Ti/Tset</li> <li>- Trigger</li> <li>- Pressure rise rate</li> <li>- Backup frequency</li> <li>- Available modes</li> </ul>	4 cmH <sub>2</sub> O to 25 cmH <sub>2</sub> O  4 cmH <sub>2</sub> O to 25 cmH <sub>2</sub> O 20% to 67% Auto, can be set to 3 levels Can be set to 3 levels Auto, 0 bpm to 35 bpm CPAP, APAP, S, autoS, autoS/T, S/T, T
<b>prisma30ST</b> <ul style="list-style-type: none"> <li>- Inspiratory positive airway pressure (IPAP)</li> <li>- Expiratory positive airway pressure (EPAP)</li> <li>- Relative inspiration duration Ti/Tset</li> <li>- Ti</li> <li>- Trigger inspiration</li> <li>- Trigger expiration</li> <li>- Pressure rise rate</li> <li>- Pressure drop rate</li> <li>- Backup frequency</li> <li>- Target volume</li> <li>- Pressure adjustment</li> <li>- Available modes</li> </ul>	4 cmH <sub>2</sub> O to 30 cmH <sub>2</sub> O  4 cmH <sub>2</sub> O to 25 cmH <sub>2</sub> O 20% to 67% 500 ms to 4000 ms Auto, can be set to 3 levels Auto, can be set to 3 levels Can be set to 4 levels Can be set to 3 levels Auto, 0 bpm to 35 bpm 300 ml to 2000 ml Can be set to 3 levels CPAP, APAP, autoS/T, S, S/T, T, aPCV

SPECIFICATION	THERAPY DEVICE	
Peak flow as per ISO 80601-2-70	Pressure measured at the patient connection opening at a flow of 40 l/min	Average flow at the patient connection opening
CPAP and APAP modes		
Test pressures:		
4 cmH <sub>2</sub> O	4.0 cmH <sub>2</sub> O	235 l/min
8 cmH <sub>2</sub> O	8.0 cmH <sub>2</sub> O	230 l/min
12 cmH <sub>2</sub> O	11.9 cmH <sub>2</sub> O	220 l/min
16 cmH <sub>2</sub> O	15.9 cmH <sub>2</sub> O	215 l/min
20 cmH <sub>2</sub> O	19.9 cmH <sub>2</sub> O	210 l/min
AcSV mode, BiLevel		
Test pressures:		
4 cmH <sub>2</sub> O	4.0 cmH <sub>2</sub> O	235 l/min
10.5 cmH <sub>2</sub> O	10.4 cmH <sub>2</sub> O	225 l/min
17 cmH <sub>2</sub> O	17.0 cmH <sub>2</sub> O	215 l/min
23.5 cmH <sub>2</sub> O	23.5 cmH <sub>2</sub> O	200 l/min
25 cmH <sub>2</sub> O	25 cmH <sub>2</sub> O	195 l/min
30.0 cmH <sub>2</sub> O	30.0 cmH <sub>2</sub> O	190 l/min
Warming of respiratory air	Max. +3°C	

SPECIFICATION	THERAPY DEVICE
Stability of the dynamic pressure (short-term accuracy) at 10 breaths/ min as per ISO 17510-1:2007 when using the 19 mm hose. 7 cmH <sub>2</sub> O 10 cmH <sub>2</sub> O 13.5 cmH <sub>2</sub> O 20 cmH <sub>2</sub> O	$\Delta p \leq 0.24 \text{ cmH}_2\text{O}$ $\Delta p \leq 0.28 \text{ cmH}_2\text{O}$ $\Delta p \leq 0.3 \text{ cmH}_2\text{O}$ $\Delta p \leq 0.4 \text{ cmH}_2\text{O}$
Stability of the dynamic pressure (short-term accuracy) at 15 breaths/ min as per ISO 17510-1:2007 when using the 19 mm hose. 7 cmH <sub>2</sub> O 10 cmH <sub>2</sub> O 13.5 cmH <sub>2</sub> O 20 cmH <sub>2</sub> O	$\Delta p \leq 0.24 \text{ cmH}_2\text{O}$ $\Delta p \leq 0.32 \text{ cmH}_2\text{O}$ $\Delta p \leq 0.4 \text{ cmH}_2\text{O}$ $\Delta p \leq 0.48 \text{ cmH}_2\text{O}$
Stability of the dynamic pressure (short-term accuracy) at 20 breaths/ min as per ISO 17510-1:2007 when using the 19 mm hose. 7 cmH <sub>2</sub> O 10 cmH <sub>2</sub> O 13.5 cmH <sub>2</sub> O 20 cmH <sub>2</sub> O	$\Delta p \leq 0.4 \text{ cmH}_2\text{O}$ $\Delta p \leq 0.32 \text{ cmH}_2\text{O}$ $\Delta p \leq 0.46 \text{ cmH}_2\text{O}$ $\Delta p \leq 0.56 \text{ cmH}_2\text{O}$

SPECIFICATION	THERAPY DEVICE
Stability of the dynamic pressure (short-term accuracy) as per ISO 80601-2-70 in CPAP and APAP modes - when using the 19 mm hose 4 cmH <sub>2</sub> O 8 cmH <sub>2</sub> O 12 cmH <sub>2</sub> O 16 cmH <sub>2</sub> O 20 cmH <sub>2</sub> O  - when using the 15 mm hose, bacteria filter, and oxygen safety valve 4 cmH <sub>2</sub> O 8 cmH <sub>2</sub> O 12 cmH <sub>2</sub> O 16 cmH <sub>2</sub> O 20 cmH <sub>2</sub> O	$\Delta p \leq 0.68 \text{ cmH}_2\text{O}$ $\Delta p \leq 0.58 \text{ cmH}_2\text{O}$ $\Delta p \leq 0.52 \text{ cmH}_2\text{O}$ $\Delta p \leq 0.44 \text{ cmH}_2\text{O}$ $\Delta p \leq 0.64 \text{ cmH}_2\text{O}$  $\Delta p \leq 1.06 \text{ cmH}_2\text{O}$ $\Delta p \leq 1 \text{ cmH}_2\text{O}$ $\Delta p \leq 1.08 \text{ cmH}_2\text{O}$ $\Delta p \leq 1.02 \text{ cmH}_2\text{O}$ $\Delta p \leq 0.96 \text{ cmH}_2\text{O}$
Stability of the dynamic pressure (short-term accuracy) as per ISO 80601-2-70 in modes with 2 pressure levels at 10 bpm inspiratory at 15 bpm inspiratory at 20 bpm inspiratory at 10 bpm expiratory at 15 bpm expiratory at 20 bpm expiratory	$\Delta p = 0.8 \text{ cmH}_2\text{O}$ $\Delta p = 1.4 \text{ cmH}_2\text{O}$ $\Delta p = 2.4 \text{ cmH}_2\text{O}$ $\Delta p = 0.6 \text{ cmH}_2\text{O}$ $\Delta p = 0.6 \text{ cmH}_2\text{O}$ $\Delta p = 0.6 \text{ cmH}_2\text{O}$
Stability of the static pressure (long-term accuracy) as per ISO 80601-2-70 - when using the 19 mm hose - when using the 15 mm hose, bacteria filter, and oxygen safety valve	$\Delta p = 0.15 \text{ cmH}_2\text{O}$ $\Delta p = 0.19 \text{ cmH}_2\text{O}$
Pressure drop via the oxygen valve at 90 l/min at 60 l/min at 30 l/min	0.5 cmH <sub>2</sub> O 0.25 cmH <sub>2</sub> O 0 cmH <sub>2</sub> O
Recommended maximum additional oxygen flow	15 l/min
Accuracy of volume measurement at 20°C	$\pm 20\%$

SPECIFICATION	THERAPY DEVICE
Filter and smoothing techniques	<ul style="list-style-type: none"> <li>• Target volume that can be set:            In the "slow" level, the device checks after every 8 breaths if the target volume has been reached and changes the pressure by 0.5 cmH<sub>2</sub>O. If the pressure reaches a corridor around the target volume, the device switches to exact regulation.            In the "medium" level, the device checks after every 5 breaths if the target volume has been reached and changes the pressure by 1.0 cmH<sub>2</sub>O. If the pressure reaches a corridor around the target volume, the device switches to exact regulation.            In the "fast" level, the device checks after every breath if the target volume has been reached and changes the pressure by 1.5 cmH<sub>2</sub>O. If the pressure reaches a corridor around the target volume, the device switches to exact regulation.</li> <li>• Alarms:            The "low minute volume" and "low tidal volume" alarms are triggered if at least three of the last five breaths were below the alarm limit. The alarms are reset automatically as soon as the corresponding alarm limit is exceeded again with at least three of the five breaths.            If a target volume is activated, the "low tidal volume" alarm is only triggered once IPAP<sub>max</sub> or PDIFF<sub>max</sub> has also been attained.            The "Apnea" alarm is triggered if apnea is identified which is longer than the set alarm limit. The alarm is reset automatically as soon as the end of the apnea is identified.</li> </ul>
Pollen filter down to 1 μm down to 0.3 μm	Filter class E10 ≥ 99.5% ≥ 85%
Service life of pollen filter	approx. 250 hours

SPECIFICATION	THERAPY DEVICE
SD card	Memory sizes of 256 MB to 8 GB can be used, interface compatible with SD physical layer version 2.0

### TOLERANCES FOR MEASUREMENTS

Pressure:	$\pm 0.75\%$ of measurement or $\pm 0.1$ cmH <sub>2</sub> O
Flow:	$\pm 4$ l/min
Temperature:	$\pm 1.5^{\circ}\text{C}$
Sound pressure level and sound power level	$\pm 2$ dB(A)

The right to make design modifications is reserved.

All flow and volume values are determined under STPD conditions.

All the parts of the therapy device are free from latex.

The WM 100 TD therapy devices use the following open source software: FreeRTOS.org

This device's software contains code which is subject to the GPL. You will receive the source code and the GPL upon request.

### 13.1.2 Technical data of power supply unit

SPECIFICATION	POWER SUPPLY UNIT
Input voltage/maximum current	100 V - 240 V AC, 3 A - 1.5 A
Input frequency	50 Hz - 60 Hz
Output voltage/maximum current	37 V DC, 2.5 A

### 13.1.3 Pressure volume curve

pV curve at  $RV=0.5\text{ l}$  and  $f=20/\text{min}$

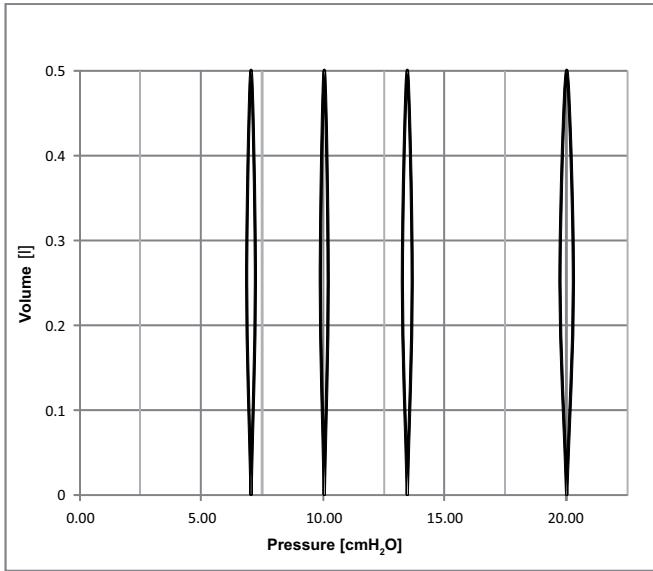

### 13.1.4 Pneumatic system diagram

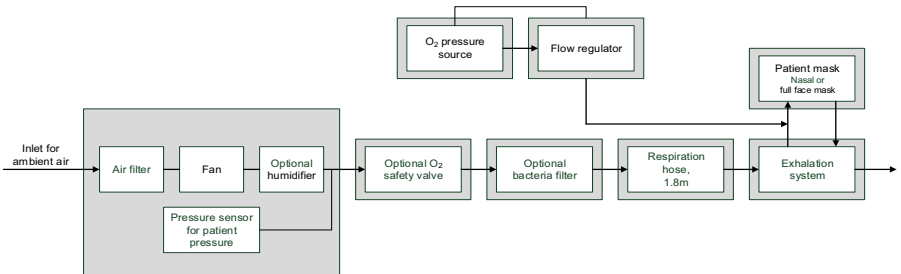

## 13.2 Emission of electromagnetic interference

<b>GUIDELINES AND MANUFACTURER DECLARATION - EMISSION OF ELECTROMAGNETIC INTERFERENCE</b>	
The device can be used in both static and mobile operation, in both domestic and appropriate hospital environments. In a domestic environment, the device may cause radio interference, possibly making it necessary to take suitable remedial measures, such as realigning the device, for example.	
<b>MEASUREMENTS OF INTERFERENCE EMISSION</b>	<b>COMPLIANCE</b>
HF emissions to CISPR 11	Group 1
HF emissions to CISPR 11	Class B
Emission of oscillations IEC 61000-3-2	Class A
Emission of voltage fluctuations/flicker to IEC 61000-3-3	Complies

## 13.3 Electromagnetic interference immunity

<b>GUIDELINES AND MANUFACTURER DECLARATION - ELECTROMAGNETIC INTERFERENCE IMMUNITY</b>			
The device can be used in both static and mobile operation, in both domestic and appropriate hospital environments. In a domestic environment, the device may cause radio interference, possibly making it necessary to take suitable remedial measures, such as realigning the device, for example.			
<b>INTERFERENCE IMMUNITY TESTS</b>	<b>IEC 60601 TEST LEVEL</b>	<b>COMPLIANCE LEVEL</b>	<b>ELECTROMAGNETIC ENVIRONMENT GUIDELINE</b>
Discharge of static electricity (ESD) to IEC 61000-4-2	± 8 kV contact discharge ± 15 kV air discharge	± 8 kV contact discharge ± 15 kV air discharge	Floors should be made of wood or concrete or have ceramic tiles laid on them. If the floor has a synthetic material laid on it, relative
Electrical fast transients/bursts to IEC 61000-4-4	± 2 kV for power supply cables ± 1 kV for input and output cables Connection	± 2 kV for power supply cables ± 1 kV for input and output cables Connection	The quality of the supply voltage should correspond to that of a typical business or hospital environment.
Surge immunity to IEC 61000-4:-5	Source impedance: 2 Ω, 18 μF: 0.5 kV, 1 kV Number of surges:	Source impedance: 2 Ω, 18 μF: 0.5 kV, 1 kV Number of surges:	The quality of the supply voltage should correspond to that of a typical business or hospital environment.

<b>GUIDELINES AND MANUFACTURER DECLARATION - ELECTROMAGNETIC INTERFERENCE IMMUNITY</b>			
<p>The device can be used in both static and mobile operation, in both domestic and appropriate hospital environments.</p> <p>In a domestic environment, the device may cause radio interference, possibly making it necessary to take suitable remedial measures, such as realigning the device, for example.</p>			
<b>INTERFERENCE IMMUNITY TESTS</b>	<b>IEC 60601 TEST LEVEL</b>	<b>COMPLIANCE LEVEL</b>	<b>ELECTROMAGNETIC ENVIRONMENT GUIDELINE</b>
Voltage dips, short interruptions and voltage variations in supply voltage to IEC 61000-4-11	Number of voltage drops: 3 drop levels/ duration: 30% / 500 ms	Number of voltage drops: 3 drop levels/ duration: 30% / 500 ms 60% / 100 ms	The quality of the supply voltage should correspond to that of a typical business or hospital environment. If the user of the device requires
Magnetic field at power frequency (50/60 Hz) to IEC 61000-4-8	30 A/m Duration: 30 s per axis Axes: x axis, y axis, z axis	30 A/m Duration: 30 s per axis Axes: x axis, y axis, z axis	Magnetic fields at power supply frequency should correspond to the values typical of those found in business and hospital





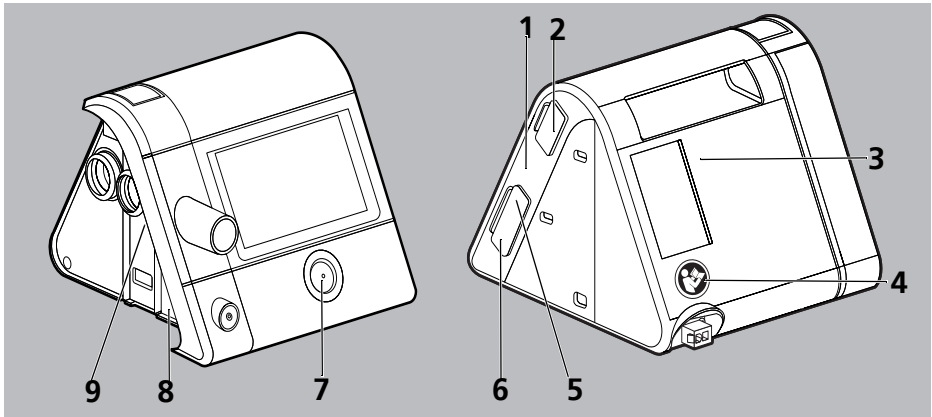

## 13.4 Electromagnetic interference immunity for ME equipment and ME systems

<b>GUIDELINES AND MANUFACTURER DECLARATION - ELECTROMAGNETIC INTERFERENCE IMMUNITY</b>			
<p>The device can be used in both static and mobile operation, in both domestic and appropriate hospital environments.</p> <p>In a domestic environment, the device may cause radio interference, possibly making it necessary to take suitable remedial measures, such as realigning the device, for example.</p>			
<b>INTERFERENCE IMMUNITY TESTS</b>	<b>IEC 60601 TEST LEVEL</b>	<b>COMPLIANCE LEVEL</b>	<b>ELECTROMAGNETIC ENVIRONMENT GUIDELINE</b>
			Portable and mobile radio equipment should not be used at a distance from the device, including its cables, of less than the recommended safety distance calculated in accordance with the equation applicable to the transmission frequency. Recommended safety distance:
Conducted HF interference to IEC 61000-4:-6	10 V <sub>effective value</sub> 150 kHz to 80 MHz within ISM bands	10 V	1.7 m
Radiated HF interference to IEC 61000-4:-3	10 V/m 80 MHz to 2.7 GHz 80% AM at 2 Hz	10 V/m	1.7 m for 80 MHz to 800 MHz 3.25 m for 800 MHz to 2.7 GHz
Magnetic field at power frequency (50/60 Hz) to IEC 61000-4-8	30 A/m	30 A/m	Magnetic fields at power supply frequency should correspond to the values typical of those found in business and hospital environments.

## 13.5 Labels and symbols







### 13.5.1 Labels on the therapy device







NO.	SYMBOL	DESCRIPTION
<b>TYPE PLATE ON THE RIGHT SIDE OF THE THERAPY DEVICE</b>		
1	SN	Serial number of the therapy device
		Year of manufacture
<b>LABELS AND SYMBOLS ON THE THERAPY DEVICE</b>		
2, 8		Consult instructions for use
3		Device inlet: inlet for room air at ambient temperature
4		Follow the instructions for use.
5		Slot for SD card
6		USB port
7		On/Off: indicates the on/off button



NO.	SYMBOL	DESCRIPTION
9		Device output: outlet for room air at 4 cmH <sub>2</sub> O to 30 cmH <sub>2</sub> O (depending on type of device)

#### TYPE PLATE ON THE UNDERSIDE OF THE THERAPY DEVICE



TYPE:	Type designation of the therapy device
37V 	37 V DC
IP21	Degree of protection against solid foreign bodies. The device is protected against dripping water.
	Degree of protection against electric shock: protection class II device
	Do not dispose of device in household waste
	Suitable for use in airplanes. Complies with RTCA/DO-160G chapter 21, Category M.
	Type BF applied part
	Manufacturer
CE 0197	CE mark (confirms that the product complies with the applicable European directives).

#### 13.5.2 Labels on the type plate of the power supply unit

SYMBOL	DESCRIPTION
	AC voltage
	DC voltage
	China RoHS label (confirms that the product does not emit toxic substances for the number of years indicated)
	Only intended for indoor use.

SYMBOL	DESCRIPTION
	Degree of protection against electric shock: protection class II device.
	Do not dispose of device in household waste.
	CE mark (confirms that the product complies with the applicable European directives).
<b>IP21</b>	IP protection class: Degree of protection against solid foreign bodies. The device is protected against dripping water.

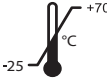
### 13.5.3 Labels on the therapy device packaging

SYMBOL	DESCRIPTION
	Permitted temperature for transport and storage: -25°C to +70°C
	Permitted humidity for transport and storage: 15% to 93% relative humidity

### 13.5.4 Labels on the respiratory hose packaging

SYMBOL	DESCRIPTION
	For use on one patient only!

## 13.6 Scope of supply

### 13.6.1 Standard scope of supply

A current list of the products included in delivery is available on the manufacturer's website or from your authorized dealer.

The following parts are supplied as standard:

PART	ARTICLE NUMBER
Basic device	Varies according to version of device
Respiration hose	WM 24445
Power supply unit	WM 29657

<b>PART</b>	<b>ARTICLE NUMBER</b>
Power supply cable	WM 24133
Set, 2 air filters	WM 29928
Transport bag	Varies according to version of device
Domed sticker with logo	WM 29899
SD card	WM 29794
Instructions for use	WM 67841

### 13.6.2 Accessories

Accessories can be ordered separately, if required. A current list of the accessories is available on the manufacturer's website or from your authorized dealer.

### 13.6.3 Spare parts

Spare parts can be ordered separately, if required. A current list of the spare parts is available on the manufacturer's website or from your authorized dealer.

## 13.7 Warranty

Starting from the date of purchase, Löwenstein Medical offers the customer a limited manufacturer's warranty on a new original Löwenstein Medical product or spare parts installed by Heinen + Löwenstein in accordance with applicable warranty terms and conditions for the particular product and the warranty periods listed below. The warranty conditions can be downloaded from the manufacturer's website. We can also send you the warranty conditions on request. In the event of a claim under warranty, please contact your specialist dealer.

<b>PRODUCT</b>	<b>WARRANTY PERIODS</b>
Devices including accessories (with the exception of: masks)	2 years
Masks, incl. accessories, batteries (unless otherwise stated in the technical documentation), sensors, hose systems	6 months
Disposable products	None

## 13.8 Declaration of conformity

The manufacturer, Löwenstein Medical Technology GmbH + Co. KG, Kronsalsweg 40, 22525 Hamburg, Germany, hereby declares that the product complies with the relevant regulations of Directive 93/42/EEC governing medical devices. The complete text of the Declaration of Conformity is available on the manufacturer's website.

CE 0197

**Löwenstein Medical  
Technology GmbH + Co. KG**

Kronsaalsweg 40  
22525 Hamburg, Germany  
T: +49 40 54702-0  
F: +49 40 54702-461

[www.loewensteinmedical.de](http://www.loewensteinmedical.de)



WM 67841f

