

A CONNECTION THAT LASTS



NORMA® Product Catalogue

Hose fasteners | Pipe and Hose connectors | Retain and Fix solutions



A strong connection for our customers

NORMA values strong partnerships and long-lasting connections.

As a customer, you benefit from a huge selection of connection solutions and tailor-made services, making NORMA® the strongest link in your business, production, or maintenance chains. We stand for a connection that lasts.



A partner at your side

We recognize that our success is built on yours. Your NORMA contact person works where YOU are: no call center, no distance. They are responsive to your needs, speak your language, and share a common cultural understanding.



Long-lasting and proven products

As an OEM manufacturer, we meet the highest quality standards and performance requirements at all times. NORMA's "fit and forget" commitment means worry-free installation without subsequent complaints or damage, driving satisfaction for you and your customers.



Universal product portfolio

Thanks to our wide range of products, we are your one-stop shop for every challenge in the field of connection and fastening technology. Our globally renowned NORMA® brand inspires confidence, making sales easier and distinguishing your business from the competition.

Professional solutions for every profession

Whether you are an engineer, a plumber or a mechanic, we can assure you that, as a professional user, you will love our extensive range of connectors and fasteners. Our hose clamps, pipe couplings, fastening elements and plastic hose connectors are technologically advanced and will help you maintain operational integrity and safety even in critical applications. With our leading brand NORMA®, we offer you first-class quality, unmatched reliability and outstanding performance. This is the reason why we have been setting the standards for excellence in advanced joining technology for over seven decades.

NORMA®'s TORRO® is considered the gold standard for the worm-drive hose clamps that are used in many different industries. Nevertheless, the brand encompasses much more than just clamps: Customers all over the world can count on the excellent performance and extraordinary longevity of our couplings, connectors and fluid lines.



No matter what industry you are active in and for which application you need a connection or fastening solution, we have the right product for sure:



General Hardware



Machine Building



Appliances



Chemical Industry



Automotive Aftermarket



Agriculture



Railway Industry



Marine & Shipbuilding



Sanitary & HVAC



Civil Engineering



Irrigation



Pharma & Biotech



FIND MORE INFORMATION:
NORMA-CONNECTS.COM



Easy, faster, better.

NORMA GROUP WEBSHOP

Your webshop benefits at a glance

- ✓ **Real-time product info**
keeps you updated on all products and new releases
- ✓ **Latest info on delivery times**
is made available without request
- ✓ **Individual pricing information**
is always up-to-date and for all products
- ✓ **Order updates**
are sent to you automatically
- ✓ **Shipment tracking for online orders**
by e-mail and in your webshop account

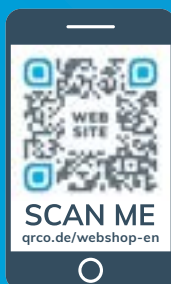

SIMPLY ORDER ONLINE NOW
NORMAGROUP-SHOP.COM





Register now for our online shop.
Exclusive to NORMA customers.

normagroup-shop.com/registration







Materials explanation

- W1** All parts entirely made from galvanized steel
- W2** NORMACLAMP® TORRO®: Band and housing stainless steel AISI 430; Screw: galvanized mild steel
 NORMACLAMP® GBS: Band and housing stainless steel AISI 430; Bolt: galvanized mild steel
 NORMACONNECT® FGR/DCS: see pages 56 and 86
- W2B** Band: stainless steel AISI 430, Screw and housing: galvanized steel
- W3** All parts entirely made from stainless steel AISI 430
- W4** All parts entirely made from stainless steel AISI 304 (or comparable)
- W5** All parts entirely made from stainless steel AISI 316 (or comparable)

| Materials International standard designations | | | | | | |
|---|---------------------------|---------|----------|----------------|------|-----|
| | DIN | AISI/AS | BS | AFNOR NF | SS | SUS |
| W1 | Entirely galvanized steel | | | | | |
| Band and housing | | | | | | |
| W2 | 1.4016 | 430 | 430 S 17 | Z8 C17 | 2320 | 430 |
| Bolt | Galvanized steel | | | | | |
| W3 | 1.4016 | 430 | 430 S 17 | Z8 C17 | 2320 | 430 |
| W4 | 1.4301 | 304 | 304 S 15 | Z6 CN 18-09 | 2332 | 304 |
| W5 | 1.4401 | 316 | 316 S 31 | Z3 CND 17-11-1 | 2347 | 316 |
| Spring insert | 1.4310 | 301 | 301 S 22 | Z12 CN 18-09 | 2331 | 301 |

Bolts

- Sk**  Hexagonal-head bolt
- Sz**  Slotted hexagonal-head bolt
- Zv**  Cylinder-head bolt
- Isk**  Inside hexagonal screw

Pictogram explanation

NORMA® offers different tools, kits, assortments and displays to fit the needs of its customers. The drawings below will help you to know, at a quick glance, if the product is available in another packaging type and/or if it has a special tool.



A tool exists for this product, please refer to the Assortment chapter



This product is available in a kit, please refer to the Assortment chapter



This product is available in an assortment box, please refer to the Assortment chapter



This product is available in display, please refer to the Assortment chapter

| Product Family | Product Category | Product Name | Page | |
|------------------------|------------------------|-----------------------------|-----------------|----|
| Worm Drive Hose Clamps | Plain Band | TORRO® | 16 | |
| | | TORRO® WF | 19 | |
| | | TORRO® TORQUE CAP | 21 | |
| | | TORRO® THUMBSCREW | 21 | |
| | | TORRO® TAMPERPROOF | 21 | |
| | | TORRO® SLOT | 22 | |
| | | TORRO® PREFIX SYSTEM | 22 | |
| | | TORRO® WF PREFIX SYSTEM | 22 | |
| | | TORRO® PREFIX CLIP | 23 | |
| | | TORRO® PREFIX DOUBLE CLIP | 23 | |
| | | TORRO® RADIAL INSERT | 23 | |
| | | TORRO® SAFETY CAP | 24 | |
| | HD | 25 | | |
| | | Perforated Band | HI-TORQUE | 26 |
| | | Quick Lock | QUICK LOCK 9 MM | 27 |
| | QUICK LOCK 12 MM | | 29 | |
| | STRIP STEEL | | 30 | |
| | QUICK LOCK HOUSING | | 31 | |
| Heavy Duty Clamps | Trunnion Clamps | GBS M | 32 | |
| | | GBS STC | 34 | |
| | | GBS QRC | 34 | |
| | | GBS MULTI-PARTS | 34 | |
| | | Profile Band | CC CLAMP | 35 |
| Quick Release | Standard | SVS | 36 | |
| | | SVS P | 38 | |
| | | SVS EYELET BOLT | 38 | |
| Retaining Clamps | Metal | S/SP | 39 | |
| | | SP SINGLE | 43 | |
| | | SP DOUBLE | 43 | |
| | | SPGU | 43 | |
| One Piece Clamps | Screwless Clamp | COBRA | 44 | |
| | Spring Band Hose Clips | FBS | 46 | |
| | | FBS R | 48 | |
| | | FBS C | 48 | |
| | | FBS HC | 48 | |
| | | FBS MC | 48 | |
| Ear Clips | One Ear Clips | EAR CLIP SINGLE | 49 | |
| | | EAR CLIP SAFE | 50 | |
| | | EAR CLIP PRO ³⁶⁰ | 51 | |
| | | CV BOOT CLAMP | 52 | |
| | | Two Ear Clips | EAR CLIP DOUBLE | 53 |

PLAIN BAND



PERFORATED BAND



QUICK LOCK



TRUNNION CLAMPS



PROFILE BAND



QUICK RELEASE



SCREWLESS CLAMP



SPRING BAND HOSE CLIPS



EAR CLIP PRO³⁶⁰



CV BOOT CLAMP





FGR FLEX



FGR RFP



DCS
UNIVERSAL
CLAW



PLASTIC
COMPRESSION
FITTINGS



EXHAUST PIPE
CLAMP ARS



EXHAUST
PIPE CLAMP
EUROCOPPLER



EXHAUST PIPE
CLAMP M8/M10



EXHAUST PIPE
CLAMP TORCTITE



PROFILE CLAMP
CLAMP V

| Product Family | Product Category | Product Name | Page | | |
|---|--------------------|-------------------------|------------------------------|------------------------|-----|
| Infrastructure Connectors | FGR | FLEX/FLEX E | 61 | | |
| | | FLEX 3 | 66 | | |
| | | GRIP/GRIP E | 69 | | |
| | | GRIP E-FP | 74 | | |
| | | RFP | 76 | | |
| | | PLAST GRIP/PLAST GRIP E | 77 | | |
| | | COMBI GRIP E | 79 | | |
| | | COMBI GRIP | 80 | | |
| | | SUPPORT SLEEVE | 81 | | |
| | | REP E | 83 | | |
| | DCS | RAPID | 88 | | |
| | | RAPID MSM | 89 | | |
| | | UNIVERSAL CLAW | 90 | | |
| | | RECORD CLAW | 91 | | |
| | | COMBI CLAW | 92 | | |
| | | CONFIX | 93 | | |
| | | Compression Fittings | Plastic Compression Fittings | OVERVIEW PRODUCT RANGE | 96 |
| MALE THREADED ADAPTOR (MA) | 98 | | | | |
| FEMALE THREADED ADAPTOR (FA) | 98 | | | | |
| MALE THREADED TEE (MT) | 99 | | | | |
| FEMALE THREADED TEE (FT) | 99 | | | | |
| MALE THREADED ELBOW - MALE BEND 90 (MB) | 100 | | | | |
| FEMALE THREADED ELBOW - FEMALE BEND 90 (FB) | 100 | | | | |
| STRAIGHT COUPLER (SC) | 101 | | | | |
| EQUAL BEND (EB) | 101 | | | | |
| EQUAL TEE (ET) | 101 | | | | |
| END CAP (EC) | 101 | | | | |
| REDUCING COUPLER (RC) | 102 | | | | |
| REDUCING TEE (RT) | 102 | | | | |
| FLANGE ADAPTOR (FLA) | 102 | | | | |
| POP-UP EQUAL BEND (PE) | 103 | | | | |
| WALL PLATE ELBOW (WPE) | 103 | | | | |
| MALE THREADED ADAPTOR WITH BRASS INSERT (MAB) | 103 | | | | |
| FEMALE THREADED ADAPTOR WITH BRASS INSERT (FAB) | 103 | | | | |
| FEMALE THREADED BEND WITH BRASS INSERT (FBB) | 103 | | | | |
| Pipe Clamps | Exhaust Pipe Clamp | | | SEC | 104 |
| | | ARS | 105 | | |
| | | RS/DIN | 107 | | |
| | | ACCUSEAL | 108 | | |
| | | ACCULOCK | 109 | | |
| | | EUROCOPPLER | 110 | | |
| | | PIPE CLAMP M8/M10 | 111 | | |
| | | EASYSEAL | 112 | | |
| | | TORCTITE | 113 | | |
| | | Wide Band Clamp | BRS / BRSP | 114 | |
| | | Profile Clamps | With Cover Band | V STC/V QRC | 115 |
| | | | Without Cover Band | VPP BRIDGE | 120 |

| Product Family | Product Category | Product Name | Page | |
|-------------------|----------------------------|--|------------------------|-----|
| Banding Systems | Polyamide Cable Ties | CABLE TIE WHITE | 122 | |
| | | CABLE TIE BLACK | 122 | |
| | | CABLE TIE COLORED | 122 | |
| | | CABLE TIE WITH METAL BARB | 124 | |
| | Stainless Steel Cable Ties | STAINLESS STEEL TIE BALL LOCKING | 125 | |
| | | Endless Band | NORMETTA® SMOOTH BAND | 127 |
| | | | NORMETTA® STAMPED BAND | 127 |
| | NORMETTA® PERFORATED BAND | | 127 | |
| | Buckles | NB-D | 128 | |
| | | NB-G | 128 | |
| | | NB-H | 129 | |
| | | NB-K | 129 | |
| | Fixing Clips and Straps | Rubber Clips | RSGU 1 | 130 |
| | | | RSGU 0 | 132 |
| RSGU 2 | | | 132 | |
| RSGUV 1 | | | 132 | |
| Metal Clips | | RS 1 | 133 | |
| | | RS 0 | 134 | |
| | | RS 2 | 134 | |
| | | RSV 1 | 134 | |
| | | HMK | 135 | |
| | | HMK SINGLE-PART HEAVY DUTY | 137 | |
| | | HMK TWO-PART HEAVY DUTY | 137 | |
| | | HMK K1 | 137 | |
| | | REINFORCED PIPE CLAMP / ISOPHONIC PIPE CLAMP | 138 | |
| | | U-BOLT CLAMP | 142 | |
| | | BSL | 144 | |
| | | BSN | 148 | |
| | | BSS | 149 | |
| | | BS | 150 | |
| Plastic Clips | | HVAC CLIP | 151 | |
| Mounting Elements | | TUBE CLAMP FITTINGS | 154 | |
| | | TRAFFIC SIGN FIXATION | 164 | |

POLYAMIDE CABLE TIES



STAINLESS STEEL CABLE TIE



ENDLESS BAND

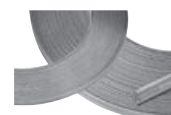

BUCKLES



RUBBER CLIP



METAL CLIPS



METAL CLIPS



HVAC CLIP



TUBE CLAMP FITTINGS



TRAFFIC SIGN FIXATION



NORMAPLAST® AND NORMAQUICK®



HOSE CONNECTORS TES



HOSE CONNECTORS WES



HOSE CONNECTORS GS



HOSE CONNECTORS YN



QUICK CONNECTORS



QUICK CONNECTORS



QUICK CONNECTORS

| Product Family | Product Category | Product Name | Page | | |
|--------------------|------------------|--------------|--------------------|----------------------------|-----|
| Plastic Connectors | Hose Connectors | SV | 168 | | |
| | | GES | 170 | | |
| | | BST | 171 | | |
| | | TES | 171 | | |
| | | WES | 172 | | |
| | | GS | 173 | | |
| | | GRS | 173 | | |
| | | TS | 173 | | |
| | | KS | 174 | | |
| | | TRS | 174 | | |
| | | YRS | 174 | | |
| | | WS | 175 | | |
| | | YS | 175 | | |
| | | GN | 175 | | |
| | | TN | 176 | | |
| | | WN | 176 | | |
| | | YN | 176 | | |
| | | EG | 177 | | |
| | | EWS | 177 | | |
| | | ET | 178 | | |
| | | EW / WV | 178 | | |
| | | VT / VTR | 178 | | |
| | | VG / VGR | 178 | | |
| | | | Quick Connectors | NORMAQUICK® S | 181 |
| | | | NEW SECTION | NORMAQUICK® SR SINGLE-LOCK | 182 |
| | | | | NORMAQUICK® PS3 | 183 |
| | | | | NORMAQUICK® V2 | 184 |

| Product Family | Product Category | Product Name | Page |
|---|------------------|--|------|
| NORMA® Kits Assortments Displays Tools Accessories | Kits | NORMACLAMP® QUICK LOCK Band-on-roll | 186 |
| | | NORMA® Fuel Line Repair Kit | 186 |
| | Assortments | NORMACLAMP® TORRO® Assortment type 120 pcs | 187 |
| | | NORMACLAMP® TORRO® WF Assortment | 187 |
| | | NORMACLAMP® COBRA® Kit type 500k | 187 |
| | | NORMACLAMP® FBS Assortment | 188 |
| | | NORMAQUICK® PLAST® Assortment | 188 |
| | | NORMAPLAST® Assortment type 365 PA 6 and TORRO® W2 | 189 |
| | | NORMACLAMP® TORRO® Dispenser | 190 |
| | Display | NORMACLAMP® TORRO® Pallet | 190 |
| NORMACLAMP® QUICK LOCK Band-on-roll dispenser | | 190 | |
| NORMACLAMP® TORRO Prepo Assembly fixture | | 191 | |
| NORMA® – Mounting tools | Mounting tools | NORMACLAMP® COBRA® Pneumatic pliers | 191 |
| | | NORMACLAMP® FBS Pneumatic pliers version S | 191 |
| | | NORMACLAMP® FBS Pneumatic pliers version W | 191 |
| | | NORMACLAMP® FBS C Multi-release tool | 191 |
| | | NORMAFIX® CABLE TIE pliers for 2.2 to 4.8 mm | 192 |
| | | NORMAFIX® CABLE TIE pliers for 4.8 to 7.8 mm | 192 |
| | | NORMAFIX® CABLE TIE pliers for 3.6 to 13 mm | 192 |
| | | NORMAFIX® CABLE TIE pliers for 4.7 to 13 mm | 192 |
| | | NORMAFIX® Pliers for stainless steel ball locking cable ties | 192 |
| | | NORMAFIX® NORMETTA® Clamping and cutting tool | 192 |
| NORMA® – Pliers | Pliers | NORMACLAMP® EAR CLIP pliers | 193 |
| | | NORMACLAMP® COBRA® Hand-held pliers CHT1 | 193 |
| | | NORMACLAMP® COBRA® Hand-held pliers CHT2 | 193 |
| | | NORMACLAMP® FBS Hand-held pliers Type 1 | 194 |
| | | NORMACLAMP® FBS Hand-held pliers Type 2 | 194 |
| | | NORMAFIX® RSGUV 1 / RSV 1 Handheld pliers | 194 |
| NORMA® – Screwdrivers | Screwdrivers | NORMACLAMP® TORRO® Screwdriver SW6, SW7, SW6/7 | 195 |
| | | NORMACLAMP® Tamperproof screwdriver | 195 |
| | | NORMACLAMP® HI-TORQUE T-screwdriver | 195 |
| | | NORMAFIX® TUBE CLAMP FITTINGS Hexagonal key | 195 |
| NORMA® – Accessories | Accessories | NORMAFIX® TUBE CLAMP FITTINGS Plastic End Cap | 196 |
| | | NORMAFIX® TUBE CLAMP FITTINGS Spare Screw | 196 |
| | | NORMAFIX® Lamppost protection tape | 196 |
| | | NORMAFIX® CABLE TIE Wall plug bases for cable tie | 197 |
| | | NORMAFIX® CABLE TIE Mounting bases for cable tie | 197 |

KITS



ASSORTMENTS



DISPLAYS



DISPLAYS



ASSEMBLY TOOLS



ASSEMBLY TOOLS



SCREWDRIVERS



PLIERS







SCREWDRIVERS

ACCESSORIES



PRODUCTS AND APPLICATIONS

| | | Machine building | White goods | Chemical industry | Irrigation systems | Ship manufacturing |
|---------------|---|---------------------------------|------------------------------|---------------------------------|---------------------------|-----------------------|
| NORMACLAMP® |  <p>NORMACLAMP® TORRO® NORMACLAMP® HD NORMACLAMP® S/SP NORMACLAMP® GBS NORMACLAMP® SVS NORMACLAMP® COBRA NORMACLAMP® FBS</p> | • • • • • • • | • • • • | • • • • • • • | • • • • • | • • • • |
| NORMACONNECT® |  <p>NORMACONNECT® FGR NORMACONNECT® BRS NORMACONNECT® ARS NORMACONNECT® RS/DIN NORMACONNECT® SEC NORMACONNECT® V</p> | • • • | | • • • | • | • |
| NORMAFIX® |  <p>NORMAFIX® RS/RSGU NORMAFIX® HMK/K NORMAFIX® NORMETTA® NORMAFIX® CABLE TIE</p> | • • • | • • | • • • | • • • • | • • • |
| NORMAPLAST® |  <p>NORMAPLAST® SV</p> | • | • | • | • | |
| NORMAQUICK® |  <p>NORMAQUICK®</p> | • | | | | |

PRODUCTS AND APPLICATIONS

| Food and beverage industry | Railway industry | Agricultural machines | Building machines | Engine manufacturing | Pump and filter | Mining industry | Building and site drainage | |
|----------------------------|-----------------------|-----------------------|-----------------------|-----------------------|-----------------------|-----------------|----------------------------|---------------|
| • | • • • • • | • • • • • | • • • • • | • • • • • | • • • • • | • • • | • | NORMACLAMP® |
| • • | • | • • • • • | • • • • • | • • • • • | • • | • | • | NORMACONNECT® |
| • • • | • • • • • | • • • • | • • • • • | • • • • | • • • • • | • • • | • | NORMAFIX® |
| • | • | • | • | • | • | | | NORMAPLAST® |
| | | • | • | • | | | | NORMAQUICK® |

NORMACLAMP®
Hose Clamps

Hose
Pipe / Spigot

NORMACONNECT®
Pipe Connections

Pipe
Pipe

NORMAFIX®
Retaining Products

Hose / Plastic* - / Metal pipe
Wall / Ceiling / Vehicle body

* Can be designed into a complete system in conjunction with NORMAFLEX® smooth and/or corrugated tube.

NORMAPLAST® Hose Connectors**
NORMAQUICK® Quick Connectors

Hose
Hose

** Several of the NORMACLAMP® products can be used.

NORMACLAMP® – Hose Clamps

A comprehensive range to suit diverse applications

Whether you're looking for static hose clamps without springs or dynamic ones with springs, single-range or multi-range clamps, with NORMACLAMP® you'll find the perfect solution for any application.





- 1 Asymmetric housing**
- even distribution of clamping forces and safe assembly
- 2 Screw support**
- safe guidance of the emerging band end
- 3 Material and clamping range stamped on the band**
- prevention of errors
- 4 Short housing saddle**
- even distribution of clamping forces in the housing area prevents leakage
- 5 Non perforated clamp band with soft elevated edges**
- optimal hose protection

Worm drive hose clamps in accordance with DIN 3017

NORMACLAMP® TORRO® multi-range hose clamps are ideally suited to applications with high mechanical loads. Thanks to the continuous developments these products have undergone, they remain the benchmark within modern clamp construction. Within the NORMACLAMP® range, only the TORRO® has its trademark asymmetrical construction. The asymmetric housing provides high force, superior torque and even distribution of clamping forces. Clamp aligns perfectly on the hose and ensures the optimal sealing of the connection.



Advantages at a glance

- ✓ Multi-range hose clamp
- ✓ No chromium (VI) used for coating purposes
- ✓ Clamping ranges in acc. with DIN 3017: 8-12 mm to 140-160 mm
- ✓ Larger diameters available on request

Applications

- Joining cooling water lines
- Depressurized and pressurized fuel lines and ventilation systems
- Oil lines
- Joining lines in sanitary applications
- Joining lines in machine building applications
- Lines in the household appliance industry
- Hose lines in the commercial vehicle industries

Materials

| W1* | W2 | W3 | W4 | W5 |
|-----|----|----|----|----|
| x | x | x | x | x |

* No chromium (VI) used for the coating on the closure components

| Material | Corrosion resistance in salt spray testing |
|----------|--|
| W1 | Min. 144 h |
| W2 | Min. 72 h |
| W3 | Min. 240 h* |
| W4 | Min. 480 h |
| W5 | Min. 1000 h |

* Max 10% base metal corrosion permissible

Types of clamp band and screw

| | | W1 | W2 | W3 | W4 | W5 |
|---------------|-------|----|----|----|----|----|
| Phillips head | SW 7* | • | • | | | |
| Slotted head | SW 7 | | | • | • | • |

* Band width 7.5 mm = SW 6

Band width 7.5 mm

- W2, W3 with smooth inside

Band width 9 mm

- W1 with smooth inside
- W2, W3, W4, W5 with stamped inside

Band width 12 mm

- W1, W2, W3 with smooth inside
- W4, W5 with stamped inside

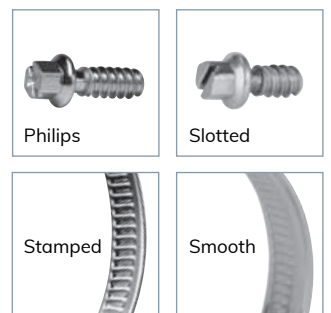

Technical data & Ordering information

| NORMACLAMP® TORRO® | | | | | | | | | | | | | |
|--------------------|-----------------------|-----------------|----------------|---------------|------|------|------|----------------|-------------------|-------------------|-------------------|-------------------|---------------|
| Width | Designation | Clamping ranges | | B | h | L | s | s (W1 only) | W1 Product No. | W2 Product No. | W4 Product No. | W5 Product No. | |
| | | in mm | in inches | | | | | | | | | | |
| 7.5 | TORRO 8-12/7.5 | 8-12 | 5/16-1/2" | 11.5 | 9 | 17 | 0.6 | | | 0116 7602 010 | | | |
| | TORRO 10-16/7.5 | 10-16 | 3/8-5/8" | 11.5 | 9 | 17 | 0.6 | | | 0116 7602 013 | | | |
| | TORRO 12-18/7.5 | 12-18 | 1/2-11/16" | 11.5 | 9 | 17 | 0.6 | | | 0116 7602 015 | | | |
| | TORRO 12-22/7.5 | 12-22 | 1/2-7/8" | 11.5 | 9 | 17 | 0.6 | | | 0116 7602 017 | | | |
| | TORRO 16-27/7.5 | 16-27 | 5/8-1 1/16" | 11.5 | 9 | 17 | 0.6 | | | 0116 7602 021 | | | |
| 9 | TORRO 8-12/9 | 8-12 | 5/16-1/2" | 13.0 | 11.0 | 21.0 | 0.65 | 0.8 | 0126 7565 010 | 0126 7702 010 | 0126 7704 010 | | |
| | TORRO 8-16/9 | 8-16 | 5/16-5/8" | 13.0 | 11.0 | 21.0 | 0.65 | 0.8 | | 0126 7702 013 | 0126 7704 013 | 0126 7705 013 | |
| | TORRO 10-16/9 | 10-16 | 5/16-5/8" | 13.0 | 11.0 | 21.0 | 0.65 | 0.8 | 0126 7565 013 | | | | |
| | TORRO 12-22/9 | 12-22 | 1/2-7/8" | 13.0 | 11.0 | 24.0 | 0.65 | 0.8 | 0126 7565 017 | 0126 7702 017 | 0126 7704 017 | 0126 7705 017 | |
| | TORRO 16-27/9 | 16-27 | 5/8-1 1/16" | 13.0 | 11.0 | 24.0 | 0.65 | 0.8 | 0126 7565 021 | 0126 7702 021 | 0126 7704 021 | 0126 7705 021 | |
| | TORRO 20-32/9 | 20-32 | 13/16-1 1/4" | 13.0 | 11.0 | 24.0 | 0.65 | 0.8 | 0126 7565 026 | 0126 7702 026 | 0126 7704 026 | 0126 7705 026 | |
| | TORRO 25-40/9 | 25-40 | 1-1 9/16" | 13.0 | 11.0 | 26.0 | 0.65 | 0.8 | 0126 7565 032 | 0126 7702 032 | 0126 7704 032 | 0126 7705 032 | |
| | TORRO 30-45/9 | 30-45 | 1 3/16-1 3/4" | 13.0 | 11.0 | 26.0 | 0.65 | 0.8 | 0126 7565 037 | 0126 7702 037 | 0126 7704 037 | 0126 7705 037 | |
| | TORRO 35-50/9 (32-50) | 35-50 | 1 3/8-2" | 13.0 | 11.0 | 26.0 | 0.65 | 0.8 | 0126 7565 043 | 0126 7702 041 | 0126 7704 041 | 0126 7705 041 | |
| | TORRO 40-60/9 | 40-60 | 1 9/16-2 3/8" | 13.0 | 11.0 | 26.0 | 0.65 | 0.8 | 0126 7565 050 | 0126 7702 050 | 0126 7704 050 | 0126 7705 050 | |
| | TORRO 50-70/9 | 50-70 | 2-2 3/4" | 13.0 | 11.0 | 26.0 | 0.65 | 0.8 | 0126 7565 060 | 0126 7702 060 | 0126 7704 060 | 0126 7705 060 | |
| | TORRO 60-80/9 | 60-80 | 2 3/8-3 1/8" | 13.0 | 11.0 | 26.0 | 0.65 | 0.8 | 0126 7565 070 | 0126 7702 070 | 0126 7704 070 | 0126 7705 070 | |
| | TORRO 70-90/9 | 70-90 | 2 3/4-3 9/16" | 13.0 | 11.0 | 26.0 | 0.65 | 0.8 | 0126 7565 080 | 0126 7702 080 | 0126 7704 080 | 0126 7705 080 | |
| | TORRO 80-100/9 | 80-100 | 3 1/8-3 15/16" | 13.0 | 11.0 | 26.0 | 0.65 | 0.8 | 0126 7565 090 | 0126 7702 090 | 0126 7704 090 | 0126 7705 090 | |
| | TORRO 90-110/9 | 90-110 | 3 9/16-4 5/16" | 13.0 | 11.0 | 26.0 | 0.65 | 0.8 | 0126 7565 100 | 0126 7702 100 | 0126 7704 100 | 0126 7705 100 | |
| | TORRO 100-120/9 | 100-120 | 3 15/16-4 3/4" | 13.0 | 11.0 | 26.0 | 0.65 | 0.8 | 0126 6565 110 | 0126 6702 110 | 0126 6704 110 | 0126 6705 110 | |
| | TORRO 110-130/9 | 110-130 | 4 5/16-5 1/8" | 13.0 | 11.0 | 26.0 | 0.65 | 0.8 | 0126 6565 120 | 0126 6702 120 | 0126 6704 120 | 0126 6705 120 | |
| | TORRO 120-140/9 | 120-140 | 4 3/4-5 1/2" | 13.0 | 11.0 | 26.0 | 0.65 | 0.8 | 0126 6565 130 | 0126 6702 130 | 0126 6704 130 | 0126 6705 130 | |
| | TORRO 130-150/9 | 130-150 | 5 1/8-5 15/16" | 13.0 | 11.0 | 26.0 | 0.65 | 0.8 | 0126 6565 140 | 0126 6702 140 | 0126 6704 140 | 0126 6705 140 | |
| | TORRO 140-160/9 | 140-160 | 5 1/2-6 5/16" | 13.0 | 11.0 | 26.0 | 0.65 | 0.8 | 0126 6565 150 | 0126 6702 150 | 0126 6704 150 | 0126 6705 150 | |
| | TORRO 150-170/9 | 150-170 | 5 7/8-6 3/4" | 13.0 | 11.0 | 26.0 | 0.65 | 0.8 | 0126 6565 160 | 0126 6702 160 | 0126 6704 160 | 0126 6705 160 | |
| | TORRO 160-180/9 | 160-180 | 6 1/4-7 1/16" | 13.0 | 11.0 | 26.0 | 0.65 | 0.8 | 0126 6565 170 | 0126 6702 170 | 012 66704 170 | 0126 6705 170 | |
| | TORRO 170-190/9 | 170-190 | 6 3/4-7 1/2" | 13.0 | 11.0 | 26.0 | 0.65 | 0.8 | 0126 6565 180 | 0126 6702 180 | 012 66704 180 | 0126 6705 180 | |
| | TORRO 180-200/9 | 180-200 | 7 1/16-7 7/8" | 13.0 | 11.0 | 26.0 | 0.65 | 0.8 | 0126 6565 190 | 0126 6702 190 | 0126 6704 190 | 0126 6705 190 | |
| | TORRO 190-210/9 | 190-210 | 7 1/2-8 1/4" | 13.0 | 11.0 | 26.0 | 0.65 | 0.8 | 0126 6565 200 | 0126 6702 200 | 0126 6704 200 | 0126 6705 200 | |
| | 12 | TORRO 16-27/12 | 16-27 | 5/8-1 1/16" | 14.6 | 12.5 | 30.0 | 0.8 | 0.8 | 0136 7352 021 | 0136 7702 021 | 0136 7704 021 | 0136 7705 021 |
| | | TORRO 20-32/12 | 20-32 | 13/16-1 1/4" | 14.6 | 12.5 | 30.0 | 0.8 | 0.8 | 0136 7352 026 | 0136 7702 026 | 0136 7704 026 | 0136 7705 026 |
| | | TORRO 25-40/12 | 25-40 | 1-1 9/16" | 14.6 | 12.5 | 30.0 | 0.8 | 1.0 | 0136 7352 032 | 0136 7702 032 | 0136 7704 032 | 0136 7705 032 |
| | | TORRO 30-45/12 | 30-45 | 1 3/16-1 3/4" | 14.6 | 12.5 | 30.0 | 0.8 | 1.0 | 0136 7352 037 | 0136 7702 037 | 0136 7704 037 | 0136 7705 037 |
| | | TORRO 35-50/12 | 35-50 | 1 3/8-2" | 14.6 | 12.5 | 30.0 | 0.8 | 1.0 | 0136 7352 043 | 0136 7702 043 | 0136 7704 043 | 0136 7705 043 |
| TORRO 40-60/12 | | 40-60 | 1 9/16-2 3/8" | 14.6 | 12.5 | 30.0 | 0.8 | 1.0 | 0136 7352 050 | 0136 7702 050 | 0136 7704 050 | 0136 7705 050 | |
| TORRO 50-70/12 | | 50-70 | 2-2 3/4" | 14.6 | 12.5 | 30.0 | 0.8 | 1.0 | 0136 7352 060 | 0136 7702 060 | 0136 7704 060 | 0136 7705 060 | |
| TORRO 60-80/12 | | 60-80 | 2 3/8-3 1/8" | 14.6 | 12.5 | 30.0 | 0.8 | 1.0 | 0136 7352 070 | 0136 7702 070 | 0136 7704 070 | 0136 7705 070 | |
| TORRO 70-90/12 | | 70-90 | 2 3/4-3 9/16" | 14.6 | 12.5 | 36.0 | 0.8 | 1.0 | 0136 7352 080 | 0136 7702 080 | 0136 7704 080 | 0136 7705 080 | |
| TORRO 80-100/12 | | 80-100 | 3 1/8-3 15/16" | 14.6 | 12.5 | 36.0 | 0.8 | 1.0 | 0136 7352 090 | 0136 7702 090 | 0136 7704 090 | 0136 7705 090 | |
| TORRO 90-110/12 | | 90-110 | 3 9/16-4 5/16" | 14.6 | 12.5 | 36.0 | 0.8 | 1.0 | 0136 7352 100 | 0136 7702 100 | 0136 7704 100 | 0136 7705 100 | |
| TORRO 100-120/12 | | 100-120 | 3 15/16-4 3/4" | 14.6 | 12.5 | 36.0 | 0.8 | 1.0 | 0136 6352 110 | 0136 6702 110 | 0136 6704 110 | 0136 6705 110 | |
| TORRO 110-130/12 | | 110-130 | 4 5/16-5 1/8" | 14.6 | 12.5 | 36.0 | 0.8 | 1.0 | 0136 6352 120 | 0136 6702 120 | 0136 6704 120 | 0136 6705 120 | |
| TORRO 120-140/12 | | 120-140 | 4 3/4-5 1/2" | 14.6 | 12.5 | 36.0 | 0.8 | 1.0 | 0136 6352 130 | 0136 6702 130 | 0136 6704 130 | 0136 6705 130 | |
| TORRO 130-150/12 | | 130-150 | 5 1/8-5 15/16" | 14.6 | 12.5 | 36.0 | 0.8 | 1.0 | 0136 6352 140 | 0136 6702 140 | 0136 6704 140 | 0136 6705 140 | |
| TORRO 140-160/12 | | 140-160 | 5 1/2-6 5/16" | 14.6 | 12.5 | 36.0 | 0.8 | 1.0 | 0136 6352 150 | 0136 6702 150 | 0136 6704 150 | 0136 6705 150 | |
| TORRO 150-170/12 | | 150-170 | 5 7/8-6 3/4" | 14.5 | 12.5 | 36.0 | 0.8 | 1.0 | 0136 6352 160 | 0136 6702 160 | 0136 6704 160 | 0136 6705 160 | |
| TORRO 160-180/12 | | 160-180 | 6 1/4-7 1/16" | 14.5 | 12.5 | 36.0 | 0.8 | 1.0 | 0136 6352 170 | 0136 6702 170 | 0136 6704 170 | 0136 6705 170 | |
| TORRO 170-190/12 | | 170-190 | 6 3/4-7 1/2" | 14.5 | 12.5 | 36.0 | 0.8 | 1.0 | 0136 6352 180 | 0136 6702 180 | 0136 6704 180 | 0136 6705 180 | |
| TORRO 180-200/12 | | 180-200 | 7 1/16-7 7/8" | 14.5 | 12.5 | 36.0 | 0.8 | 1.0 | 0136 6352 190 | 0136 6702 190 | 0136 6704 190 | 0136 6705 190 | |
| TORRO 190-210/12 | | 190-210 | 7 1/2-8 1/4" | 14.5 | 12.5 | 36.0 | 0.8 | 1.0 | 0136 6352 200 | 0136 6702 200 | 0136 6704 200 | 0136 6705 200 | |
| TORRO 200-220/12 | | 200-220 | 7 7/8-8 5/8" | 14.5 | 12.5 | 36.0 | 0.8 | 1.0 | 0136 6352 210 | 0136 6702 210 | 0136 6704 210 | 0136 6705 210 | |
| TORRO 210-230/12 | | 210-230 | 8 1/4-9 1/16" | 14.5 | 12.5 | 36.0 | 0.8 | 1.0 | 0136 6352 220 | 0136 6702 220 | 0136 6704 220 | 0136 6705 220 | |
| TORRO 220-240/12 | | 220-240 | 8 5/8-9 1/2" | 14.5 | 12.5 | 36.0 | 0.8 | 1.0 | 0136 6352 230 | 0136 6702 230 | 0136 6704 230 | 0136 6705 230 | |
| TORRO 230-250/12 | | 230-250 | 9 1/16-9 7/8" | 14.5 | 12.5 | 36.0 | 0.8 | 1.0 | 0136 6352 240 | 0136 6702 240 | 0136 6704 240 | 0136 6705 240 | |
| TORRO 240-260/12 | | 240-260 | 9 1/2-10 1/4" | 14.5 | 12.5 | 36.0 | 0.8 | 1.0 | 0136 6352 250 | 0136 6702 250 | 0136 6704 250 | 0136 6705 250 | |
| TORRO 250-270/12 | | 250-270 | 9 7/8-10 5/8" | 14.5 | 12.5 | 36.0 | 0.8 | 1.0 | 0136 6352 260 | 0136 6702 260 | 0136 6704 260 | 0136 6705 260 | |
| TORRO 260-280/12 | | 260-280 | 10 1/4-11" | 14.5 | 12.5 | 36.0 | 0.8 | 1.0 | 0136 6352 270 | 0136 6702 270 | 0136 6704 270 | 0136 6705 270 | |
| TORRO 270-290/12 | | 270-290 | 10 5/8-11 3/8" | 14.5 | 12.5 | 36.0 | 0.8 | 1.0 | 0136 6352 280 | 0136 6702 280 | 0136 6704 280 | 0136 6705 280 | |
| TORRO 280-300/12 | | 280-300 | 11-11 7/8" | 14.5 | 12.5 | 36.0 | 0.8 | 1.0 | 0136 6352 290 | 0136 6702 290 | 0136 6704 290 | 0136 6705 290 | |

Additional diameters on request (up to 700 mm).
Our recommendation for bigger diameters:
Hi-Torque product group. See page 26.
Available in W3 on request.

Refer to pages 187, 189, 190 and 195

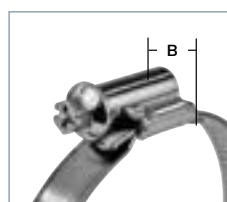

B = overall width housing

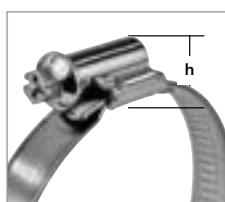

h = overall height bolt and housing

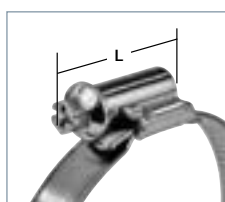

L = overall length bolt and housing

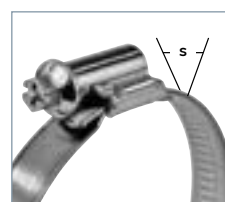

s = band thickness clamp band

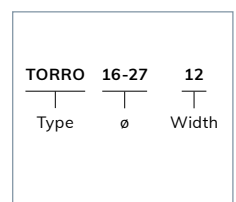

Name structure clamp band





The TORRO® WF clamp is fitted with a wave spring which automatically re-tensions to ensure optimal radial clamping force. The TORRO® WF is the ideal choice for applications under extreme temperature changes (e.g. charged air), under extremely low temperatures or for the retention of hoses with a tendency of “creeping”/hose relaxation.

Advantages at a glance

- Automatic re-tensioning effect in the event of hose relaxation
- Increased sealing reliability across a wide temperature range



Materials

W3, W4

NORMACLAMP®

| NORMACLAMP® TORRO® WF | | | | | | | | | |
|-----------------------|--------------------|-----------------|----------------|------|------|------|---------------|-------------------|-------------------|
| Width | Designation | Clamping ranges | | B | h | L | s | W3 Product No. | W4 Product No. |
| | | in mm | in inches | | | | | | |
| 9 | TORRO WF 10-16/9 | 10-16 | 3/8 - 5/8" | 13.0 | 11.0 | 21.0 | 0.65 | 0127 7708 013 | 0127 7711 013 |
| | TORRO WF 12-18/9 | 12-18 | 1/2-11/16" | 13.0 | 11.0 | 24.0 | 0.65 | 0127 7708 018 | 0127 7711 015 |
| | TORRO WF 12-20/9 | 12-20 | 1/2-13/16" | 13.0 | 11.0 | 24.0 | 0.65 | 0127 7708 016 | 0127 7711 016 |
| | TORRO WF 12-22/9 | 12-22 | 1/2-7/8" | 13.0 | 11.0 | 24.0 | 0.65 | 0127 7708 017 | 0127 7711 017 |
| | TORRO WF 16-25/9 | 16-25 | 5/8-1" | 13.0 | 11.0 | 24.0 | 0.65 | 0127 7708 020 | 0127 7711 020 |
| | TORRO WF 16-27/9 | 16-27 | 5/8-1 1/16" | 13.0 | 11.0 | 24.0 | 0.65 | 0127 7708 021 | 0127 7711 021 |
| | TORRO WF 20-32/9 | 20-32 | 13/16-1 1/4" | 13.0 | 11.0 | 24.0 | 0.65 | 0127 7708 026 | 0127 7711 026 |
| | TORRO WF 23-35/9 | 23-35 | 15/16-1 3/8" | 13.0 | 11.0 | 24.0 | 0.65 | 0127 7708 029 | 0127 7711 029 |
| | TORRO WF 25-40/9 | 25-40 | 1-1 9/16" | 13.0 | 11.0 | 26.0 | 0.65 | 0127 7708 032 | 0127 7711 032 |
| | TORRO WF 30-45/9 | 30-45 | 1 3/16-1 3/4" | 13.0 | 11.0 | 26.0 | 0.65 | 0127 7708 037 | 0127 7711 037 |
| | TORRO WF 32-50/9 | 32-50 | 1 3/8-2" | 13.0 | 11.0 | 26.0 | 0.65 | 0127 7708 041 | 0127 7711 041 |
| | TORRO WF 40-60/9 | 40-60 | 1 9/16-2 3/8" | 13.0 | 11.0 | 26.0 | 0.65 | 0127 7708 050 | 0127 7711 050 |
| | TORRO WF 45-65/9 | 45-65 | 1 3/4-2 9/16" | 13.0 | 11.0 | 26.0 | 0.65 | 0127 7708 055 | 0127 7711 055 |
| | TORRO WF 50-70/9 | 50-70 | 2-2 3/4" | 13.0 | 11.0 | 26.0 | 0.65 | 0127 7708 060 | 0127 7711 060 |
| | TORRO WF 60-80/9 | 60-80 | 2 3/8-3 1/8" | 13.0 | 11.0 | 26.0 | 0.65 | 0127 7708 070 | 0127 7711 070 |
| | TORRO WF 70-90/9 | 70-90 | 2 3/4-3 9/16" | 13.0 | 11.0 | 26.0 | 0.65 | 0127 7708 080 | 0127 7711 080 |
| | TORRO WF 80-100/9 | 80-100 | 3 1/8-3 15/16" | 13.0 | 11.0 | 26.0 | 0.65 | 0127 7708 090 | 0127 7711 090 |
| | TORRO WF 90-110/9 | 90-110 | 3 9/16-4 5/16" | 13.0 | 11.0 | 26.0 | 0.65 | 0127 7708 100 | 0127 7711 100 |
| TORRO WF 100-120/9 | 100-120 | 3 15/16-4 3/4" | 13.0 | 11.0 | 26.0 | 0.65 | 0127 7708 110 | 0127 7711 110 | |
| TORRO WF 110-130/9 | 110-130 | 4 3/8-5 1/8" | 13.0 | 11.0 | 26.0 | 0.65 | 0127 7708 120 | 0127 7711 120 | |
| 12 | TORRO WF 16-27/12 | 16-27 | 5/8-1 1/16" | 14.6 | 12.5 | 30.0 | 0.8 | 0137 7708 021 | 0137 7711 021 |
| | TORRO WF 20-32/12 | 20-32 | 13/16-1 1/4" | 14.6 | 12.5 | 30.0 | 0.8 | 0137 7708 026 | 0137 7711 026 |
| | TORRO WF 25-40/12 | 25-40 | 1-1 9/16" | 14.6 | 12.5 | 30.0 | 0.8 | 0137 7708 032 | 0137 7711 032 |
| | TORRO WF 30-45/12 | 30-45 | 1 3/16-1 3/4" | 14.6 | 12.5 | 30.0 | 0.8 | 0137 7708 037 | 0137 7711 037 |
| | TORRO WF 35-50/12 | 35-50 | 1 3/8-2" | 14.6 | 12.5 | 30.0 | 0.8 | 0137 7708 043 | 0137 7711 043 |
| | TORRO WF 40-60/12 | 40-60 | 1 9/16-2 3/8" | 14.6 | 12.5 | 30.0 | 0.8 | 0137 7708 050 | 0137 7711 050 |
| | TORRO WF 50-70/12 | 50-70 | 2-2 3/4" | 14.6 | 12.5 | 30.0 | 0.8 | 0137 7708 060 | 0137 7711 060 |
| | TORRO WF 60-80/12 | 60-80 | 2 3/8-3 1/8" | 14.6 | 12.5 | 30.0 | 0.8 | 0137 7708 070 | 0137 7711 070 |
| | TORRO WF 70-90/12 | 70-90 | 2 3/4-3 9/16" | 14.6 | 12.5 | 36.0 | 0.8 | 0137 7708 080 | 0137 7711 080 |
| | TORRO WF 80-100/12 | 80-100 | 3 1/8-3 15/16" | 14.6 | 12.5 | 36.0 | 0.8 | 0137 7708 090 | 0137 7711 090 |
| TORRO WF 90-110/12 | 90-110 | 3 9/16-4 5/16" | 14.6 | 12.5 | 36.0 | 0.8 | 0137 7708 100 | 0137 7711 100 | |

Available in W2 on request

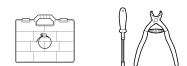

Refer to pages 187 and 195

Table of torques

NORMACLAMP®

| NORMACLAMP® TORRO® | | | | |
|--------------------|------------|---------------------|---------|-----|
| Band width (mm) | Material | Diameters | TT | FRT |
| 7.5 | W2, W3 | all diameters | 1.5 | - |
| 9 | W1 | 8-12 mm | 2.5+0.5 | 1.2 |
| | | all other diameters | 3+0.5 | 1.2 |
| | W2 | 10-16 mm | 2+0.5 | 0.7 |
| | | all other diameters | 3+0.5 | 0.7 |
| | W3, W4, W5 | 10-16 mm | 2+0.5 | 0.7 |
| | | all other diameters | 3+0.5 | 0.7 |
| 12 | W1 | all diameters | 5+0.5 | 1.2 |
| | W2, W3 | all diameters | 5+0.5 | 1 |
| | W4, W5 | all diameters | 5+0.5 | 1 |

TT = Tightening Torque
 FRT = Free Running Torque

NORMACLAMP® TORRO® with torque cap

The torque cap shears off when the permissible tightening torque is reached, thus saving the need to use a torque wrench. The bolt slot can still be accessed even after the break-off point, meaning that the clamp can be removed and/or re-tensioned if necessary. Available in 9 and 12 mm band widths on request.

Advantages at a glance

- Defined tightening torque without the need for special tools
- Installation can be checked visually

Materials

W1, W2, W3, W4



Refer to page 195

NORMACLAMP® TORRO® Thumb screw

The NORMACLAMP® TORRO® Thumb screw can be comfortably tightened by hand using the wide screw head. Available in 9 and 12 mm band widths on request.

Main advantage

The clamp can be tightened or opened manually

Materials

W1, W2, W3, W4, W5



Refer to page 195

NORMACLAMP® TORRO® Tamperproof

The NORMACLAMP® TORRO® Tamperproof can only be mounted and dismantled by using the Tamperproof Screwdriver – details on page 199. The specially designed screw head has three radial grooves, which means it cannot be adjusted with any commercially available tools. Automated assembly using a torque gun is particularly effective, as the special shape of the screw head allows for minimal misalignment or offset. Available in 9 and 12 mm band widths on request.

Main advantage

Non-dismountable clamps protect against manipulation

Material

W3, W4



Refer to page 195

Slot



The slot is a clever means of pre-positioning the TORRO® hose clip on the hose. In this case the oval hole in the clamp band finds its exact counterpart on the hose surface. Thus the TORRO® is safely and accurately kept in place prior to the final assembly. Available in band widths of 9 and 12 mm and different angles on request.

Main advantage

- Safe pre-assembly on rubber sleeves and molded pipes

Material

W3



Refer to page 195

Prefix system



The NORMACLAMP® TORRO® Prefix system is a concept for integrated clamps and clips on hoses and pipes. Demand for complete systems that include the appropriate sealing function is increasing. This system can only be fixed by using a special tool. Available in band widths of 9 and 12 mm on request.

Advantages at a glance

- Safe pre-assembly on hoses and molded pipes
- Two versions, left- and right-handed. Works on silicone and rubber hoses

Materials

W3, W4



Refer to page 191

WF Prefix system



The NORMACLAMP® TORRO® WF Prefix system is the combination of the NORMACLAMP® TORRO® WF and the NORMACLAMP® Prefix system. This system can only be fixed by using a special tool. Available in 9 and 12 mm band widths on request.

Advantages at a glance

- Axial and radial adjustment of the clamp
- Possible for multilayer hoses and blow molded pipes
- Already available in series for different hose thickness
- Clinch design
- Two versions, left- and right-handed
- Works on silicone and rubber hoses

Materials

W3, W4



Refer to page 191

Prefix clip



With this feature the TORRO® can also be pre-positioned on the hose. The two 'teeth' of this device keep the TORRO® hose clip safely in place if it needs to be stocked or transported prior to its final assembly. Available in band widths of 9 and 12 mm on request.

Advantages at a glance

- Safe pre-assembly on the hose
- Two versions, left- and right-handed

Materials

W3, W4



Refer to page 195

Prefix Double clip



With this feature the TORRO® can also be pre-positioned on the hose. The 'teeth' of the clips keep the TORRO® hose clip safely in place if it needs to be stocked or transported prior to its final assembly. Available for the TORRO® with band width 12 mm.

Advantages at a glance

- Safe pre-assembly on the hose
- Two versions, left- and right-handed

Materials

W3, W4



Refer to page 195

Radial insert



Compared to standard worm drive hose clamps, the Radial Insert is a "Spring Clamp", which offers optimal contraction and expansion capabilities. It is suitable for all applications where the hose is exposed to temperature fluctuations. The special design ensures a reliable seal throughout the complete thermal cycle. Available for the TORRO® with band width 9 mm.

Advantages at a glance

- The internal sliding sleeve optimizes clamping pressure
- High contact pressure due to the radially corrugated design
- Compensates for temperature fluctuations

Material

W1



Refer to page 195

Safety cap



The NORMACLAMP® TORRO® safety cap is a small plastic cap which covers the end of the clamp band, thus stopping injuries from occurring and making a significant contribution to accident prevention measures.

Main advantage

Available band widths

| | | |
|--------|---|---------------|
| 7.5 mm | – | 0045 8000 021 |
| 9 mm | – | 0045 8000 022 |
| 12 mm | – | 0045 8000 023 |

Material

PVC



- 1 Extended bridge
- 2 16 mm band width
- for applications where harsh torques and contact pressures are required
- 3 Clamping range stamped on the band
- prevention of errors

Worm drive hose clamps

NORMACLAMP® HD is suitable for special applications where harsh torques and contact pressures are required. This clamp is an add-on type to our range of worm drive hose clips and therefore only available in 16 mm band width and W4 material quality.

Main advantage

- ✓ The extended bridge prevents leaks and hose being damaged

Applications

- Mounting of silicone, plastic and rubber tubing with steel inserts

Materials

| Material | Corrosion resistance in salt spray testing |
|----------|--|
| W4 | Min. 240 h* |

* Max 5% corrosion of the base material allowed

Torques

| Band width | Failure torque (min. value) | Recommended tightening torque |
|------------|-----------------------------|-------------------------------|
| 16 | 17 Nm | max. 10 Nm* |

* Depending on the type of application

Technical data & Ordering information

| NORMACLAMP® HD | | | | | | | | |
|----------------|------------------|-----------------|--------------|------|------|------|-----|----------------|
| Width | Designation | Clamping ranges | | B | h | L | s | W4 Product No. |
| | | in mm | in inches | | | | | |
| 16 | HD 25-45/16 C8 | 25-45 | 1-1 3/4" | 23.0 | 13.0 | 37.0 | 0.7 | 0156 7804 035 |
| | HD 32-54/16 C8 | 32-54 | 1 1/4-2 1/8" | 23.0 | 13.0 | 37.0 | 0.7 | 0156 7804 043 |
| | HD 45-67/16 C8 | 45-67 | 1 3/4-2 5/8" | 23.0 | 13.0 | 37.0 | 0.7 | 0156 7804 056 |
| | HD 57-79/16 C8 | 57-79 | 2 1/4-3 1/8" | 23.0 | 13.0 | 37.0 | 0.7 | 0156 7804 068 |
| | HD 70-92/16 C8 | 70-92 | 2 3/4-3 5/8" | 23.0 | 13.0 | 37.0 | 0.7 | 0156 7804 081 |
| | HD 83-105/16 C8 | 83-105 | 3 1/4-4 1/8" | 23.0 | 13.0 | 37.0 | 0.7 | 0156 7804 094 |
| | HD 95-118/16 C8 | 95-118 | 3 3/4-4 5/8" | 23.0 | 13.0 | 37.0 | 0.7 | 0156 7804 106 |
| | HD 108-130/16 C8 | 108-130 | 4 1/4-5 1/8" | 23.0 | 13.0 | 37.0 | 0.7 | 0156 7804 119 |
| | HD 121-143/16 C8 | 121-143 | 4 3/4-5 5/8" | 23.0 | 13.0 | 37.0 | 0.7 | 0156 7804 132 |
| | HD 133-156/16 C8 | 133-156 | 5 1/4-6 1/8" | 23.0 | 13.0 | 37.0 | 0.7 | 0156 7804 144 |
| | HD 146-168/16 C8 | 146-168 | 5 3/4-6 5/8" | 23.0 | 13.0 | 37.0 | 0.7 | 0156 7804 157 |
| | HD 159-181/16 C8 | 159-181 | 6 1/4-7 1/8" | 23.0 | 13.0 | 37.0 | 0.7 | 0156 7804 170 |
| | HD 172-194/16 C8 | 172-194 | 6 3/4-7 5/8" | 23.0 | 13.0 | 37.0 | 0.7 | 0156 7804 183 |
| | HD 184-206/16 C8 | 184-206 | 7 1/4-8 1/8" | 23.0 | 13.0 | 37.0 | 0.7 | 0156 7804 195 |
| | HD 197-219/16 C8 | 197-219 | 7 3/4-8 5/8" | 23.0 | 13.0 | 37.0 | 0.7 | 0156 7804 208 |
| | HD 210-232/16 C8 | 210-232 | 8 1/4-9 1/8" | 23.0 | 13.0 | 37.0 | 0.7 | 0156 7804 221 |

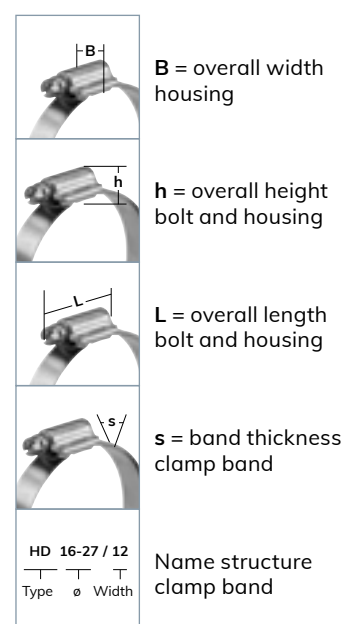

Other sizes available on request

Refer to page 195

HI-TORQUE CLAMP

NORMACLAMP®

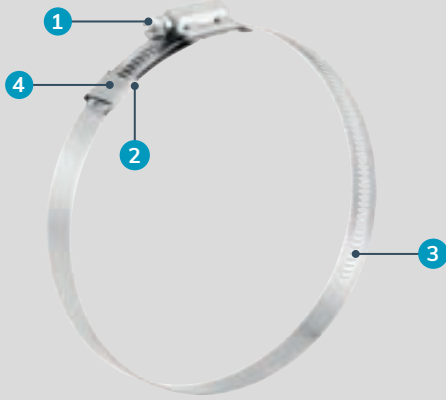

- 1 Screw housing for easy tightening
- 2 'In-line' housing, which enables every thread on the worm to engage with the band
- 3 Perforated band
- 4 Safety buckle, keeping the band aligned

Signage clamp

The NORMACLAMP® Hi-Torque Signage Clamp is produced using components entirely manufactured from stainless steel. The construction of the worm-drive housing on the band facilitates installation of a wide range of signs. Hi-Torque clamps are reusable and easy to retighten after

expansion caused by temperature fluctuations, and their construction ensures that during installation there are no sharp edges which might cause injury to the installer. The recommended tightening torque for secure and reliable installation is 16 Nm and the breaking torque is more than 20 Nm.

Advantages at a glance

- ✓ Reusable
- ✓ Secure and reliable installation
- ✓ Easy to retighten in cases of expansion (due to temperature fluctuations)
- ✓ No loss of material when installing
- ✓ Easy installation of two signs on one pole

Applications

- Traffic signs, street signs, billboards and illuminated signs installation
- Heavy duty sealing applications
- Agricultural
- Chemical Industry
- Food Processing
- Fluid Transfer
- Marine Industry
- Petrochemical Industry
- Shipyards

Materials

| | | | | |
|----|----|----|----|----|
| W1 | W2 | W3 | W4 | W5 |
| | | | x | |

Technical data & Ordering information

| NORMACLAMP® HI-TORQUE | | | | |
|-----------------------|----------------------|-----------------|--------------|----------------|
| Width | Designation | Clamping ranges | | W4 Product No. |
| | | in mm | in inches | |
| 16 | HI-TORQUE 32-67/16 | 32-67 | 1 1/4-2 5/8" | 0560 6610 050 |
| | HI-TORQUE 54-105/16 | 54-105 | 2 1/8-4 1/8" | 0560 6610 080 |
| | HI-TORQUE 102-156/16 | 102-156 | 4-6 1/8" | 0560 6610 129 |
| | HI-TORQUE 156-232/16 | 156-232 | 6 1/8-9 1/8" | 0560 6610 194 |
| | HI-TORQUE 229-384/16 | 229-384 | 9-15 1/8" | 0560 6610 307 |



Refer to page 195

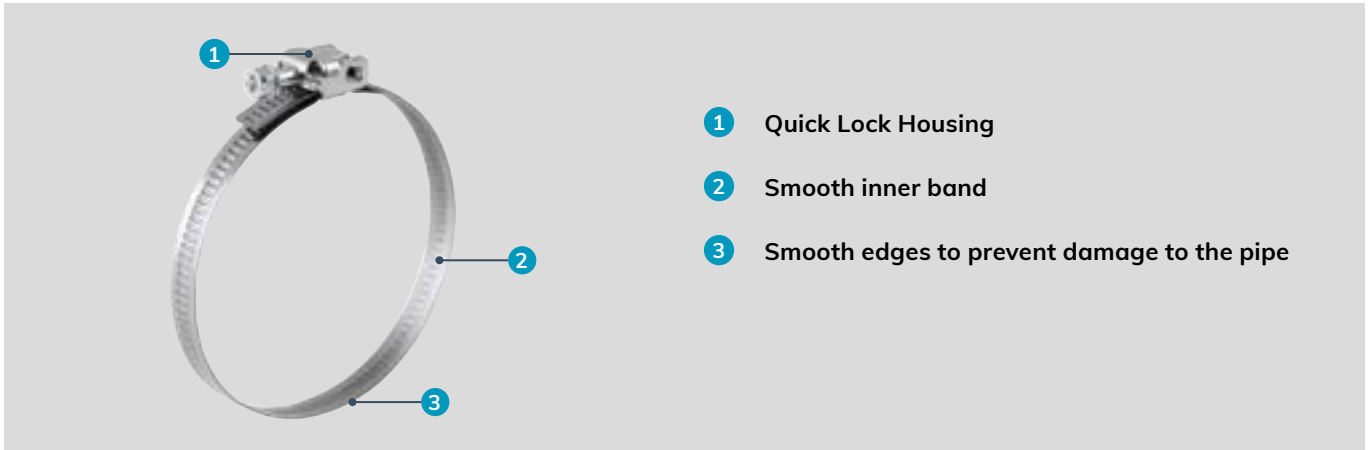

- 1 Quick Lock Housing
- 2 Smooth inner band
- 3 Smooth edges to prevent damage to the pipe

Quick locking clamp

NORMACLAMP® Quick Lock 9 mm is manufactured from a continuously threaded band with smooth edges to prevent damage to the pipe. The Quick Lock housing allows easy

and quick application, as the band can be adjusted to the right diameter of the pipe, before securing the lock with the screw. Band thickness 0.6 mm for band width 9 mm.

Advantages at a glance

- ✓ Easy and quick application
- ✓ Safe joint with the hose
- ✓ Flexibility
- ✓ Clamping range from 25-40 up to 60-1300 mm

Applications

- Water industry
- Air conditioning
- Construction
- Sanitary

Materials

| | | | | |
|----|---------|----|----|----|
| W1 | W2 (B)* | W3 | W4 | W5 |
| | x | | x | |

* W2 (B): Band in stainless steel (W3)
 Screw and housing in galvanized steel (W1)
 W2 (B) is a combination of W1 and W3 materials

Torques

| Band width | Tightening torque | Tightening speed |
|------------|-------------------|------------------|
| 9 | 2.5+0.5 Nm | Max. 50 RPM |

Technical data & Ordering information

NORMACLAMP®

| NORMACLAMP® QUICK LOCK 9 MM | | | | | |
|-----------------------------|---------------------|-----------------|------------------|-----------------------|-------------------|
| Width | Designation | Clamping ranges | | W2 (B) Product No. | W4 Product No. |
| | | in mm | in inches | | |
| 9 | QUICK LOCK 25-45/9 | 25-45 | 1-1 3/4" | 0815 6120 045 | |
| | QUICK LOCK 40-60/9 | 40-60 | 1 9/16-2 3/8" | 0815 6120 060 | |
| | QUICK LOCK 60-90/9 | 60-90 | 2 3/8-3 9/16" | 0815 6120 090 | |
| | QUICK LOCK 60-110/9 | 60-110 | 2 3/8-4 5/16" | 0815 6120 110 | 0815 6130 110 |
| | QUICK LOCK 60-135/9 | 60-135 | 2 3/8-5 5/16" | 0815 6120 135 | 0815 6130 135 |
| | QUICK LOCK 60-145/9 | 60-145 | 2 3/8-5 11/16" | 0815 6120 145 | 0815 6130 145 |
| | QUICK LOCK 60-170/9 | 60-170 | 2 3/8-6 11/16" | | 0815 6130 170 |
| | QUICK LOCK 60-175/9 | 60-175 | 2 3/8-6 7/8" | 0815 6120 175 | |
| | QUICK LOCK 60-215/9 | 60-215 | 2 3/8-8 7/16" | 0815 6120 215 | 0815 6130 215 |
| | QUICK LOCK 60-270/9 | 60-270 | 2 3/8-10 5/8" | 0815 6120 270 | 0815 6130 270 |
| | QUICK LOCK 60-325/9 | 60-325 | 2 3/8-12 13/16" | 0815 6120 325 | 0815 6130 325 |
| | QUICK LOCK 60-380/9 | 60-380 | 2 3/8- 14 15/16" | 0815 6120 380 | 0815 6130 380 |
| | QUICK LOCK 60-425/9 | 60-425 | 2 3/8-16 3/4" | 0815 6120 425 | 0815 6130 425 |
| | QUICK LOCK 60-525/9 | 60-525 | 2 3/8-20 11/16" | 0815 6120 525 | 0815 6130 525 |
| | QUICK LOCK 60-660/9 | 60-660 | 2 3/8-26" | 0815 6120 660 | 0815 6130 660 |

Additional diameters available on request



Refer to page 186 and 190

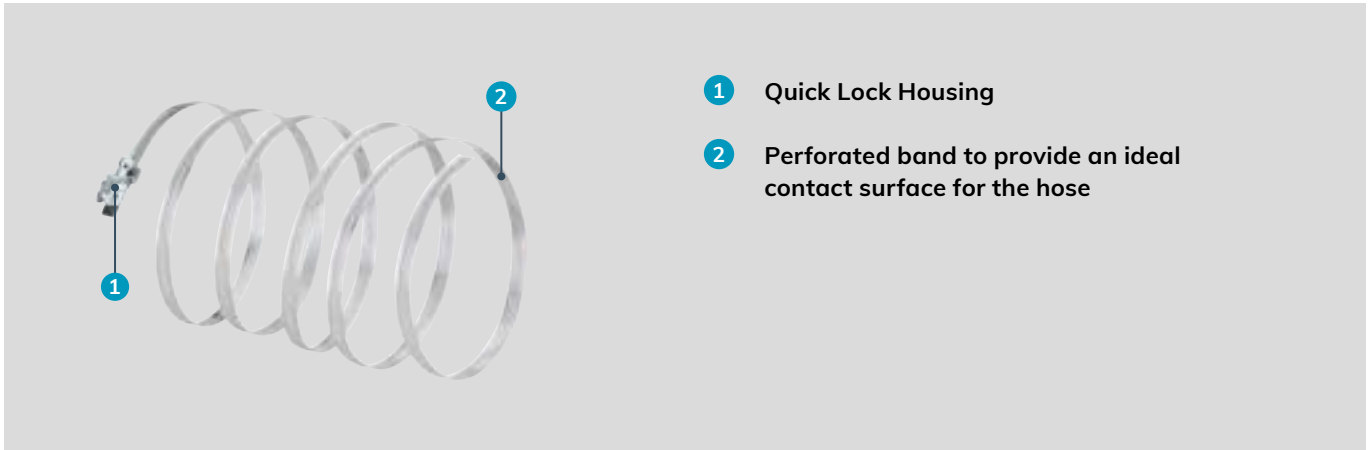

- 1 Quick Lock Housing
- 2 Perforated band to provide an ideal contact surface for the hose

The clamp for large hoses

NORMACLAMP® Quick Lock 12 mm is designed for quick-lock tightening and releasing of large diameter hoses and supplied in a perforated band, to provide an ideal contact surface for the hose. This clamp is the ideal solution for larger hose diameters over 100 mm. Band thickness 0.7 mm for band width 12 mm assures a very flexible clamp.

Advantages at a glance

- ✓ The quick-lock housing eases the assembly of the clamp
- ✓ Safe joint with the hose
- ✓ Flexibility
- ✓ Wide clamping range

Applications

- Water industry
- Air conditioning
- Construction
- Sanitary

Materials

| | | | | |
|----|---------|----|----|----|
| W1 | W2 (B)* | W3 | W4 | W5 |
| | x | | | |

* W2 (B): Band in stainless steel (W3)
 Screw and housing in galvanized steel (W1)
 W2 (B) is a combination of W1 and W3 materials

Technical data & Ordering information

| NORMACLAMP® QUICK LOCK 12 MM | | | | |
|------------------------------|----------------------|-----------------|-------------|-----------------------|
| Width | Designation | Clamping ranges | | W2 (B) Product No. |
| | | in mm | in inches | |
| 12 | QUICK LOCK 50-110/12 | 50-110 | 2-4 5/16" | 0815 6020 080 |
| | QUICK LOCK 50-130/12 | 50-130 | 2-5 1/8" | 0815 6020 090 |
| | QUICK LOCK 50-145/12 | 50-145 | 2-5 11/16" | 0815 6020 098 |
| | QUICK LOCK 50-165/12 | 50-165 | 2-6 1/2" | 0815 6020 108 |
| | QUICK LOCK 50-175/12 | 50-175 | 2-6 7/8" | 0815 6020 113 |
| | QUICK LOCK 50-215/12 | 50-215 | 2-8 7/16" | 0815 6020 133 |
| | QUICK LOCK 50-280/12 | 50-280 | 2-11" | 0815 6020 165 |
| | QUICK LOCK 50-325/12 | 50-325 | 2-12 13/16" | 0815 6020 188 |
| | QUICK LOCK 50-370/12 | 50-370 | 2-14 9/16" | 0815 6020 210 |
| | QUICK LOCK 50-425/12 | 50-425 | 2-16 3/4" | 0815 6020 238 |
| | QUICK LOCK 60-525/12 | 60-525 | 2-20 11/16" | 0815 6020 293 |
| | QUICK LOCK 70-625/12 | 70-625 | 2-24 5/8" | 0815 6020 348 |



Refer to page 186

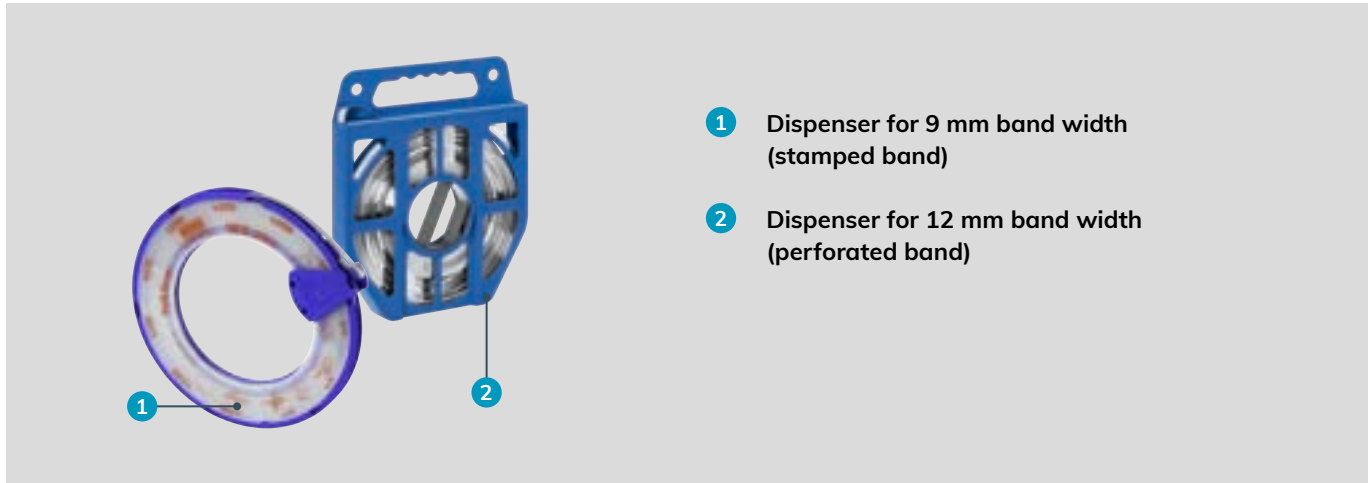

Continuous band for multiple clamp diameters

The NORMACLAMP® Strip Steel is a perfect solution for creating clamps with different diameters depending on a user's needs. Strip Steel is a long continuous band available in 9 or 12 mm band width. For closing the clamp use the NORMACLAMP® Quick Lock Housings in 9 or 12 mm.

Advantages at a glance

- ✓ Variability
- ✓ Flexibility
- ✓ Storage and inventory benefit
- ✓ Allows making up to 44 clamps

Applications

- Water industry
- Air conditioning
- Construction
- Sanitary

Materials

| | | | | |
|----|---------|----|----|----|
| W1 | W2 (B)* | W3 | W4 | W5 |
| | x | | x | |

* W2 (B): Band in stainless steel (W3)
 Screw and housing in galvanized steel (W1)
 W2 (B) is a combination of W1 and W3 materials

Technical data & Ordering information

| NORMACLAMP® STRIP STEEL | | | | | |
|-------------------------|-----------------------|--------|---------|-----------------------|-------------------|
| Width | Designation | Length | | W2 (B) Product No. | W4 Product No. |
| | | in m | in inch | | |
| 9 | STRIP STEEL 9 30 MTS | 30 | 118 1/8 | 0815 7121 008 | 0815 7131 008 |
| 12 | STRIP STEEL 12 25 MTS | 25 | 98 7/16 | 0815 0007 006 | |

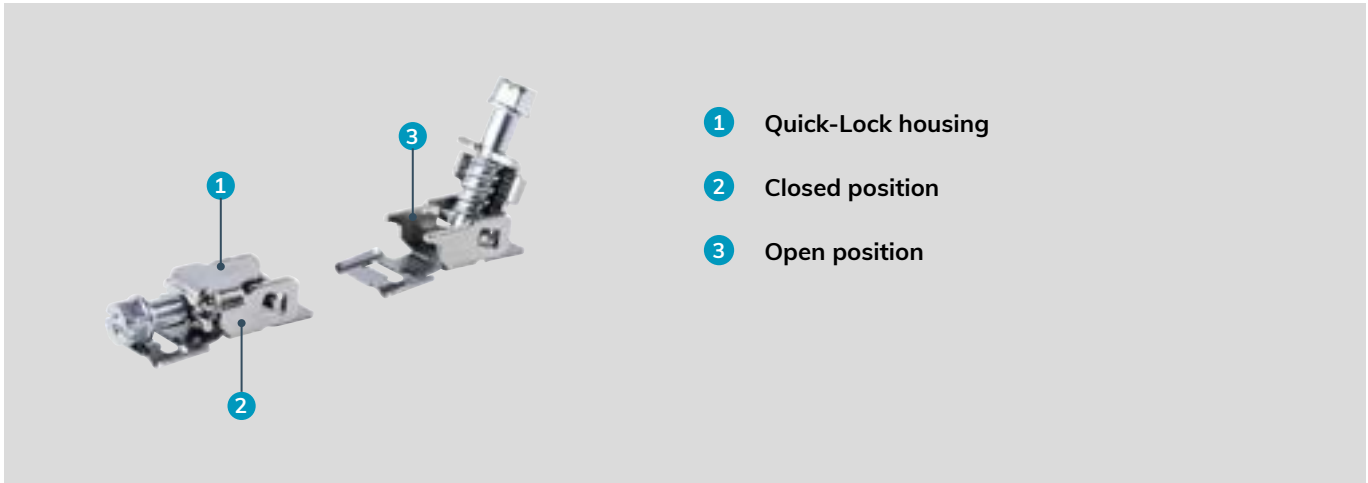

Locking system for continuous band

The NORMACLAMP® Quick Lock Housings in 9 and 12 mm are used to close the NORMACLAMP® Strip Steel.

Advantages at a glance

- ✓ Fast, simple and safe assembly
- ✓ Enables the closing of clamps of many diameters

Applications

- Water industry
- Air conditioning
- Construction
- Sanitary

Materials

| W1 | W2 (B)* | W3 | W4 | W5 |
|----|---------|----|----|----|
| | x | | x | |

* W2 (B): Band in stainless steel (W3)
 Screw and housing in galvanized steel (W1)
 W2 (B) is a combination of W1 and W3 materials

Technical data & Ordering information

| NORMACLAMP® QUICK LOCK HOUSING | | | |
|--------------------------------|-----------------------|-----------------------|-------------------|
| Width | Designation | W2 (B) Product No. | W4 Product No. |
| 9 | QUICK LOCK HOUSING 9 | 0815 7121 007 | 0815 7131 007 |
| 12 | QUICK LOCK HOUSING 12 | 0815 6007 008 | |

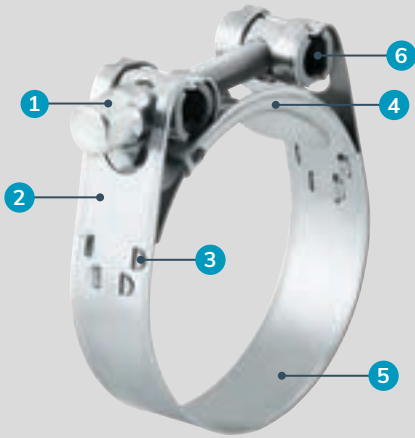

- 1 Bolt**
- New specially designed bolt with integrated spacer and improved performance. The W5 version has a socket head cap bolt.
- 2 Reinforced band loops**
- ability to withstand much higher torques
- 3 Mechanically locked closure**
- no welding spots and no contact corrosion
- 4 Bridge**
- hose protection
- 5 Robust band with rounded edges**
- prevents injuries and damage to hoses
- 6 Hollow trunnions**
- reduces the tensile forces on the bolt and the mechanical lock

Heavy-duty clamps for multiple applications

NORMACLAMP® GBS M is designed primarily for use in applications where hose clamps must meet stringent requirements. In particular if suction and pressure hoses – complete with plastic or steel inserts and high shore hardness values – are to be connected and attached. They are particularly suitable for use on commercial and special vehicles. NORMACLAMP® GBS M clamps' ability to withstand exceptionally high levels of band tensile force is an outstanding feature. They are also extremely easy to install, whether you're using manual, pneumatic or electrical standard tools.



Advantages at a glance

- ✔ Failure torques improved by a factor of two
- ✔ Band tensile force levels improved by a factor of three

Applications

- Machine building
- Chemical industry
- Irrigation systems
- Ship manufacturing
- Railway industry
- Agricultural machines
- Building machines
- Engine manufacturing
- Pump and filter
- Mining Industry

Materials

| | | | | |
|----|----|----|----|----|
| W1 | W2 | W3 | W4 | W5 |
| x | x | | x | x |

| Material | Corrosion resistance in salt spray testing |
|----------|--|
| W1 | Min. 72 h |
| W2 | Min. 72 h |
| W4 | Min. 240 h |
| W5 | Min. 400 h |

| NORMACLAMP® GBS M | | | | | | |
|-------------------|--------------------------|-----|-----|-----|----|----|
| Band width | Material thickness in mm | | | | | |
| | W1 | W2 | W4 | W5 | M | SW |
| 18 | 0.8 | 0.6 | 0.6 | 0.6 | 6 | 8 |
| 20 | 1.0 | 0.8 | 0.8 | 0.8 | 7 | 10 |
| 25 | 1.0 | 1.0 | 1.0 | 1.0 | 8 | 13 |
| 30 | 1.3 | 1.0 | 1.0 | 1.0 | 10 | 17 |

Band tensile force

Numerous test results underline the technical superiority of NORMACLAMP® GBS M products over their competitors':

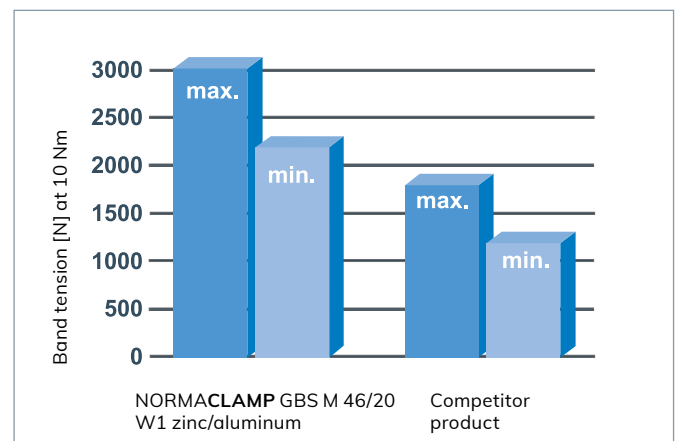

Table of torques

| NORMACLAMP® GBS M | | | | | |
|-------------------|-----------------------------|----|----|----|----------------------------------|
| Band width | Failure torque (minimum) Nm | | | | Recommended tightening torque Nm |
| | W1 | W2 | W4 | W5 | |
| 18 | 15 | 15 | 15 | 15 | 8 |
| 20 | 25 | 20 | 20 | 20 | 10 |
| 25 | 35 | 30 | 30 | 30 | 20 |
| 30 | 50 | 45 | 45 | 45 | 25 |

| NORMACLAMP® GBS M RUBBER INSERT | | | |
|---------------------------------|-----------------------------|----|----------------------------------|
| Band width | Failure torque (minimum) Nm | | Recommended tightening torque Nm |
| | W1 | W2 | |
| 18 | 10 | 10 | 6 |
| 20 | 15 | 15 | 8 |
| 25 | 25 | 25 | 18 |
| 30 | 40 | 40 | 22 |

Please note: the recommended tightening speed should not exceed 250 rpm

Technical data & Ordering information

| NORMACLAMP® GBS M HOLLOW TRUNNION | | | | | | | |
|-----------------------------------|---------------------|-----------------|-------------------|----------------|----------------|----------------|------------------|
| Width | Designation | Clamping ranges | | W1 Product No. | W2 Product No. | W4 Product No. | W5** Product No. |
| | | in mm | in inches | | | | |
| 18 | GBS M 17-19/18 Sk* | 17-19 | 11/16-3/4" | 0591 7181 018 | 0591 7182 018 | 0591 7184 018 | 0591 7185 018 |
| | GBS M 19-21/18 Sk* | 19-21 | 3/4-13/16" | 0591 7181 020 | 0591 7182 020 | 0591 7184 020 | 0591 7185 020 |
| | GBS M 21-23/18 Sk* | 21-23 | 13/16-15/16" | 0591 7181 022 | 0591 7182 022 | 0591 7184 022 | 0591 7185 022 |
| | GBS M 23-25/18 Sk* | 23-25 | 15/16-1" | 0591 7181 024 | 0591 7182 024 | 0591 7184 024 | 0591 7185 024 |
| | GBS M 25-27/18 Sk | 25-27 | 1-1 1/16" | 0591 7181 026 | 0591 7182 026 | 0591 7184 026 | 0591 7185 026 |
| | GBS M 27-29/18 Sk | 27-29 | 1 1/16-1 1/8" | 0591 7181 028 | 0591 7182 028 | 0591 7184 028 | 0591 7185 028 |
| | GBS M 29-31/18 Sk | 29-31 | 1 1/8-1 1/4" | 0591 7181 030 | 0591 7182 030 | 0591 7184 030 | 0591 7185 030 |
| | GBS M 31-34/18 Sk | 31-34 | 1 1/4-1 5/16" | 0591 7181 033 | 0591 7182 033 | 0591 7184 033 | 0591 7185 033 |
| | GBS M 34-37/18 Sk | 34-37 | 1 5/16-1 7/16" | 0591 7181 036 | 0591 7182 036 | 0591 7184 036 | 0591 7185 036 |
| | GBS M 37-40/18 Sk | 37-40 | 1 7/16-1 9/16" | 0591 7181 039 | 0591 7182 039 | 0591 7184 039 | 0591 7185 039 |
| 20 | GBS M 40-43/18 Sk | 40-43 | 1 9/16-1 11/16" | 0591 7181 042 | 0591 7182 042 | 0591 7184 042 | 0591 7185 042 |
| | GBS M 43-47/20 Sk | 43-47 | 1 11/16-1 7/8" | 0591 7201 045 | 0591 7202 045 | 0591 7204 045 | 0591 7205 045 |
| | GBS M 47-51/20 Sk | 47-51 | 1 7/8-2" | 0591 7201 049 | 0591 7202 049 | 0591 7204 049 | 0591 7205 049 |
| | GBS M 51-55/20 Sk | 51-55 | 2-2 3/16" | 0591 7201 053 | 0591 7202 053 | 0591 7204 053 | 0591 7205 053 |
| | GBS M 55-59/20 Sk | 55-59 | 2 3/16-2 5/16" | 0591 7201 057 | 0591 7202 057 | 0591 7204 057 | 0591 7205 057 |
| | GBS M 59-63/20 Sk | 59-63 | 2 5/16-2 1/2" | 0591 7201 061 | 0591 7202 061 | 0591 7204 061 | 0591 7205 061 |
| 25 | GBS M 63-68/20 Sk | 63-68 | 2 1/2-2 11/16" | 0591 7201 066 | 0591 7202 066 | 0591 7204 066 | 0591 7205 066 |
| | GBS M 68-73/25 Sk | 68-73 | 2 11/16-2 7/8" | 0591 7251 071 | 0591 7252 071 | 0591 7254 071 | 0591 7255 071 |
| | GBS M 73-79/25 Sk | 73-79 | 2 7/8-3 1/8" | 0591 7251 076 | 0591 7252 076 | 0591 7254 076 | 0591 7255 076 |
| | GBS M 79-85/25 Sk | 79-85 | 3 1/8-3 3/8" | 0591 7251 082 | 0591 7252 082 | 0591 7254 082 | 0591 7255 082 |
| | GBS M 85-91/25 Sk | 85-91 | 3 3/8-3 9/16" | 0591 7251 088 | 0591 7252 088 | 0591 7254 088 | 0591 7255 088 |
| | GBS M 91-97/25 Sk | 91-97 | 3 9/16-3 13/16" | 0591 7251 094 | 0591 7252 094 | 0591 7254 094 | 0591 7255 094 |
| | GBS M 97-104/25 Sk | 97-104 | 3 13/16-4 1/6" | 0591 7251 101 | 0591 7252 101 | 0591 7254 101 | 0591 7255 101 |
| | GBS M 104-112/25 Sk | 104-112 | 4 1/16-4 7/16" | 0591 7251 108 | 0591 7252 108 | 0591 7254 108 | 0591 7255 108 |
| 30 | GBS M 112-121/25 Sk | 112-121 | 4 7/16-4 3/4" | 0591 7251 117 | 0591 7252 117 | 0591 7254 117 | 0591 7255 117 |
| | GBS M 121-130/25 Sk | 121-130 | 4 3/4-5 1/8" | 0591 7251 126 | 0591 7252 126 | 0591 7254 126 | 0591 7255 126 |
| | GBS M 130-140/30 Sk | 130-140 | 5 1/8-5 1/2" | 0591 7301 135 | 0591 7302 135 | 0591 7304 135 | 0591 7305 135 |
| | GBS M 140-150/30 Sk | 140-150 | 5 1/2-5 15/16" | 0591 7301 145 | 0591 7302 145 | 0591 7304 145 | 0591 7305 145 |
| | GBS M 150-162/30 Sk | 150-162 | 5 15/16-6 3/8" | 0591 7301 156 | 0591 7302 156 | 0591 7304 156 | 0591 7305 156 |
| | GBS M 162-174/30 Sk | 162-174 | 6 3/8-6 7/8" | 0591 7301 168 | 0591 7302 168 | 0591 7304 168 | 0591 7305 168 |
| 30 | GBS M 174-187/30 Sk | 174-187 | 6 7/8-7 3/8" | 0591 7301 181 | 0591 7302 181 | 0591 7304 181 | 0591 7305 181 |
| | GBS M 187-200/30 Sk | 187-200 | 7 3/8-7 7/8" | 0591 7301 194 | 0591 7302 194 | 0591 7304 194 | 0591 7305 194 |
| | GBS M 200-213/30 Sk | 200-213 | 7 7/8-8 3/8" | 0591 7301 207 | 0591 7302 207 | 0591 7304 207 | 0591 7305 207 |
| | GBS M 213-226/30 Sk | 213-226 | 8 3/8-8 7/8" | 0591 7301 220 | 0591 7302 220 | 0591 7304 220 | 0591 7305 220 |
| | GBS M 226-239/30 Sk | 226-239 | 8 7/8-9 7/16" | 0591 7301 233 | 0591 7302 233 | 0591 7304 233 | 0591 7305 233 |
| | GBS M 239-252/30 Sk | 239-252 | 9 7/16-9 15/16" | 0591 7301 246 | 0591 7302 246 | 0591 7304 246 | 0591 7305 246 |
| | GBS M 252-265/30 Sk | 252-265 | 9 15/16-10 7/16" | 0591 7301 259 | 0591 7302 259 | 0591 7304 259 | 0591 7305 259 |
| | GBS M 265-278/30 Sk | 265-278 | 10 7/16-10 15/16" | 0591 7301 272 | 0591 7302 272 | 0591 7304 272 | 0591 7305 272 |
| | GBS M 279-291/30 Sk | 279-291 | 11-11 7/16" | 0591 7301 285 | 0591 7302 285 | 0591 7304 285 | 0591 7305 285 |
| | GBS M 292-304/30 Sk | 292-304 | 11 1/2-12" | 0591 7301 298 | 0591 7302 298 | 0591 7304 298 | 0591 7305 298 |

* These diameters are full trunnions and do not feature a mechanically locked closure, they are spot-welded.

** ISK bolt for W5 material



GBS – VERSIONS

GBS STC – with solid trunnions



To suit the requirements of all markets, NORMACLAMP® GBS is also available with solid trunnions. Available on request in band width 18, 20, 25 and 30 mm in both materials (W1 and W4).

Main advantage

Strong robustness

Materials

W1, W4



Refer to page 195

GBS QRC – with quick release closure



NORMACLAMP® GBS is also available with a quick release closure. The bolt on the closure is easy to release, ensuring straightforward installation and removal. Available on request in band width 18, 20, 25 and 30 mm in both materials (W1 and W2).

Main advantage

Easy to install

Materials

W1, W2



Refer to page 195

GBS – Multi-parts



NORMACLAMP® GBS is also available in a multi-part version for bigger diameters. Available on request in band width 18, 20, 25 and 30 mm in materials (W1, W2, W4 and W5).

Main advantage

Suitable for big diameter hoses

Material

W1, W2, W4, W5



Refer to page 195

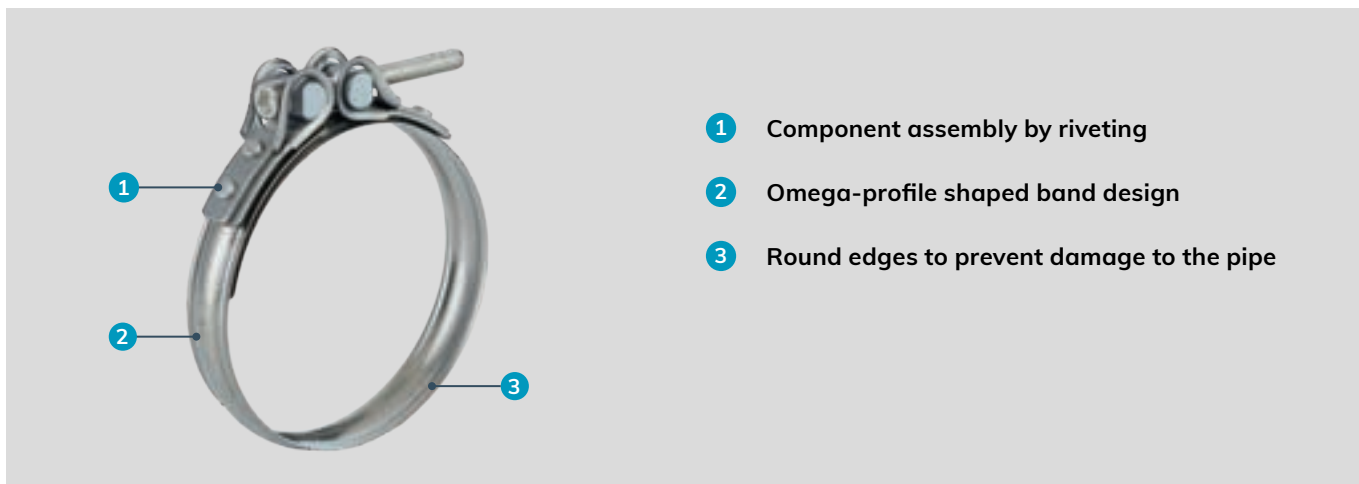

- 1 Component assembly by riveting
- 2 Omega-profile shaped band design
- 3 Round edges to prevent damage to the pipe

Connecting hoses for charged air application

NORMACLAMP® CC is a high performance clamp designed to connect rubber or silicon hoses in high pressure applications. It produces a constantly sealed joint between turbocharger and engine under extremely high temperature and pressure variations.

Advantages at a glance

- ✓ Uniform radial distribution of clamping forces
- ✓ No intercrystalline corrosion
- ✓ High surface pressure compared to flat band clamps
- ✓ Spring function included in omega profile band

Applications

Automotive industry – charged air for turbochargers

Materials

| | | | | |
|----|----|----|----|----|
| W1 | W2 | W3 | W4 | W5 |
| | | x | | |

Technical data & Ordering information

| NORMACLAMP® CC | | | |
|----------------|-------------|-----------------|-------------------|
| Width | Designation | Clamping ranges | W3 Product No. |
| | | in mm | |
| 17 | CC 70-72 | 70 - 72 | 0596 6001 072 |
| | CC 72-74 | 72 - 74 | 0596 6001 074 |
| | CC 80-82 | 80 - 82 | 0596 6001 082 |
| | CC 82-84 | 82 - 84 | 0596 6001 084 |
| | CC 84-86 | 84 - 86 | 0596 6001 086 |
| | CC 86-88 | 86 - 88 | 0596 6001 088 |
| | CC 88-90 | 88 - 90 | 0596 6001 090 |
| | CC 90-92 | 90 - 92 | 0596 6001 092 |
| | CC 92-94 | 92 - 94 | 0596 6001 094 |
| | CC 94-96 | 94 - 96 | 0596 6000 096 |
| | CC 96-98 | 96 - 98 | 0596 6000 098 |
| | CC 98-100 | 98 - 100 | 0596 6000 100 |
| | CC 100-102 | 100 - 102 | 0596 6000 102 |
| | CC 102-104 | 102 - 104 | 0596 6000 104 |
| | CC 104-106 | 104 - 106 | 0596 6000 106 |
| | CC 106-108 | 106 - 108 | 0596 6001 108 |
| | CC 108-110 | 108 - 110 | 0596 6001 110 |
| CC 110-112 | 110 - 112 | 0596 6000 112 | |
| CC 112-114 | 112 - 114 | 0596 6000 114 | |
| CC 114-116 | 114 - 116 | 0596 6000 116 | |
| CC 120-122 | 120 - 122 | 0596 6000 122 | |
| CC 122-124 | 122 - 124 | 0596 6000 124 | |
| CC 124-126 | 124 - 126 | 0596 6000 126 | |
| CC 132-134 | 132 - 134 | 0596 6000 134 | |
| CC 134-136 | 134 - 136 | 0596 6000 136 | |



- 1 Quick close and release**
- Secure over-center lever for manual opening and closing without the need for installation tools
- 2 Bridge**
- Optimum hose protection

Quick-release clamps

NORMACLAMP® SVS and NORMACLAMP® SVS P clamps are secure, flexible joining elements designed for applications where joints need to be closed and released frequently and quickly, such as filtering and filling systems or food industry pipeline systems that are continually being cleaned.

NORMACLAMP® SVS clamps provide optimal protection for hose applications. NORMACLAMP® SVS P clamps provide optimal protection for pipe applications. NORMACLAMP® SVS PR clamps provide optimal protection for flange applications – see our profile section from page 115.

Main advantage

- ✓ Ideal for frequent handling

Applications

- Machine building
- Chemical industry
- Food and beverage industry
- Railway industry
- Building machines
- Pump and filter

Materials

| | | | | |
|----|----|----|----|----|
| W1 | W2 | W3 | W4 | W5 |
| | | | x | |

| Material | Corrosion resistance in salt spray testing |
|----------|--|
| W4 | Min. 240 h |

Technical data

| Quick-release hose clamps (SVS) | | | | | | | |
|---------------------------------|-----------------------|-----------------------|----------------|-------|--------------|---|-----------------|
| Band width | Minimum \varnothing | Maximum \varnothing | Material W4 | Bolts | | | Closing force N |
| | | | | (Oe) | Zy \ominus | M | |
| 15 | 80 | 500 | 0.6 | (•) | • | 6 | 80 |
| 20 | 80 | 500 | 0.8 | (•) | • | 6 | 80 |
| 25 | 80 | 500 | 1.0 | (•) | • | 6 | 80 |

Technical data & Ordering information

| NORMACLAMP® SVS | | | |
|-----------------|----------------------------|---------------|---------------|
| Diameter in mm | Material W4 Product No. | | |
| | Band width | | |
| | 15 mm | 20 mm | 25 mm |
| 80 - 90 | 0565 0154 ... | 0565 0204 ... | 0565 0254 ... |
| up to 100 | 0565 0154 ... | 0565 0204 ... | 0565 0254 ... |
| up to 110 | 0565 0154 ... | 0565 0204 ... | 0565 0254 ... |
| up to 120 | 0565 0154 ... | 0565 0204 ... | 0565 0254 ... |
| up to 130 | 0565 0154 ... | 0565 0204 ... | 0565 0254 ... |
| up to 140 | 0565 0154 ... | 0565 0204 ... | 0565 0254 ... |
| up to 150 | 0565 0154 ... | 0565 0204 ... | 0565 0254 ... |
| up to 160 | 0565 0154 ... | 0565 0204 ... | 0565 0254 ... |
| up to 170 | 0565 0154 ... | 0565 0204 ... | 0565 0254 ... |
| up to 180 | 0565 0154 ... | 0565 0204 ... | 0565 0254 ... |
| up to 190 | 0565 0154 ... | 0565 0204 ... | 0565 0254 ... |
| up to 200 | 0565 0154 ... | 0565 0204 ... | 0565 0254 ... |
| up to 210 | 0565 0154 ... | 0565 0204 ... | 0565 0254 ... |
| up to 220 | 0565 0154 ... | 0565 0204 ... | 0565 0254 ... |
| up to 230 | 0565 0154 ... | 0565 0204 ... | 0565 0254 ... |
| up to 240 | 0565 0154 ... | 0565 0204 ... | 0565 0254 ... |
| up to 250 | 0565 0154 ... | 0565 0204 ... | 0565 0254 ... |
| up to 260 | 0565 0154 ... | 0565 0204 ... | 0565 0254 ... |
| up to 270 | 0565 0154 ... | 0565 0204 ... | 0565 0254 ... |
| up to 280 | 0565 0154 ... | 0565 0204 ... | 0565 0254 ... |
| up to 290 | 0565 0154 ... | 0565 0204 ... | 0565 0254 ... |
| up to 300 | 0565 0154 ... | 0565 0204 ... | 0565 0254 ... |

... = Ø without decimals in mm

Additional diameters available on request

SVS – VERSIONS

SVS P



NORMACLAMP® SVS P clamps provide optimal protection for pipe applications. Available in band widths of 15, 20 and 25 mm on request.

Advantages at a glance

- Closure can be opened and closed easily by hand
- No installation tools required
- Ideal for frequent handling

Material

W4

Eyelet bolt



As an alternative, the NORMACLAMP® SVS clamp closure can be fitted with an eyelet bolt. This can be particularly useful if gloves are worn during installation. Available in band widths of 15, 20 and 25 mm on request.

Advantages at a glance

- Eyelet bolt suitable for light duty series
- Easy to install even if wearing gloves

Material

W4



- 1 Powerful clamping brackets structure**
 - high level of clamping force
 - excellent sealing properties
- 2 Bridge**
 - optimal hose protection

DIN 3016, DIN 3017

Thanks to their robust clamping brackets structure featuring metric bolts, NORMACLAMP® S/SP clamps provide a high level of clamping force. The two-part version is recommended for exceptionally high pressure and tensile loads.



Advantages at a glance

- ✓ High level of clamping force
- ✓ Even contact pressure
- ✓ Elbow fittings, brackets or lugs can be attached
- ✓ Clamps can be fitted with a rubber profile to absorb vibrations and protect against the ingress of creeping water

Applications

- Machine building
- Chemical industry
- Irrigation systems
- Ship manufacturing
- Railway industry
- Agricultural machines
- Building machines
- Engine manufacturing
- Pump and filter

Materials



| | | | | |
|----|----|----|----|----|
| W1 | W2 | W3 | W4 | W5 |
| | | | x* | x |

* Only for the 30 mm band width

| Material | Corrosion resistance in salt spray testing |
|----------|--|
| W1 | Min. 72 h |
| W5 | Min. 400 h |

| NORMACLAMP® S/SP | | | | | |
|------------------------------|--------------------|--------------------------|-----|--------------------------------------|-----|
| Band width b ₁ | Minimum Ø in mm | Material thickness in mm | | | |
| | | S | | SP | |
| | | W1 | W5 | W1 | W5 |
| 5 | 5 | 0.2 | – | 0.2 | – |
| 7 | 6 | 0.3/0.4 | 0.4 | 0.4 | 0.4 |
| 9 | 9 | 0.4 | 0.4 | 0.6 | 0.4 |
| 12 | 12 | 0.5 | 0.5 | 0.7 | 0.5 |
| 15 | 20 | 0.6 | 0.6 | 0.8 | 0.6 |
| 20 | 25 | 1.0 | 0.8 | (up to ø 47) 1.0 (from ø 48) 1.25 | 0.8 |
| 25 | 50 | 1.25 | 1.0 | 1.25/1.5 | 1 |

Bolts

| NORMACLAMP® S/SP | | | |
|------------------|--|--|--|
| Band width mm | Zy  | Sz  | Sk  |
| 5 | M 2x12 | | |
| 7 | M 3x16 | | |
| 9 | M 4x22 | M 4 x 20 | |
| 12 | | M 5x25 | |
| 15 | | M 6x30 | |
| 20 | | M 8x40 | |
| 25 | | | M 10x45 |

Static torques

| NORMACLAMP® S/SP | | |
|------------------------------------|--------------------------------|--------------------------|
| Band width b ₁ mm | Static tightening torque Nm | Static test torque Nm |
| | max. | |
| 7 | 0.5 | 0.6 |
| 9 | 1.2 | 1.5 |
| 12 | 1.5 | 1.8 |
| 15 | 4 | 4.8 |
| 20 | 12 | 14.5 |
| 25 | 30 | 36 |

Static torques according to DIN 3017-2

Technical data & Ordering information

| NORMACLAMP® S | | | | | | | | | | |
|-----------------------------|-------------------|---------------|---------------|---------------|---------------|-------------------|---------------|---------------|---------------|---------------|
| Clamping diameter, mm | W1 Product No. | | | | | W5 Product No. | | | | |
| | Band width | | | | | Band width | | | | |
| | 7 mm Zy | 9 mm Zy | 12 mm Sz | 15 mm Sz | 20 mm Sz | 7 mm Zy | 9 mm Zy | 12 mm Sz | 15 mm Sz | 20 mm Sz |
| 6 | 0110 8980 006 | | | | | 0110 0700 006 | | | | |
| 7 | 0110 8980 007 | | | | | 0110 0700 007 | | | | |
| 8 | 0110 8980 008 | | | | | 0110 0700 008 | | | | |
| 9 | 0110 8980 009 | 0120 8980 009 | | | | 0110 0700 009 | 0120 0700 009 | | | |
| 10 | 0110 8980 010 | 0120 8980 010 | | | | 0110 0700 010 | 0120 0700 010 | | | |
| 11 | 0110 8980 011 | 0120 8980 011 | | | | 0110 0700 011 | 0120 0700 011 | | | |
| 12 | 0110 8980 012 | 0120 8980 012 | 0130 0005 012 | | | 0110 0700 012 | 0120 0700 012 | 0130 0705 012 | | |
| 13 | | 0120 8980 013 | 0130 0005 013 | | | | 0120 0700 013 | 0130 0705 013 | | |
| 14 | | 0120 8980 014 | 0130 0005 014 | | | | 0120 0700 014 | 0130 0705 014 | | |
| 15 | | 0120 8980 015 | 0130 0005 015 | | | | 0120 0700 015 | 0130 0705 015 | | |
| 16 | | 0120 8980 016 | 0130 0005 016 | | | | 0120 0700 016 | 0130 0705 016 | | |
| 17 | | 0120 8980 017 | 0130 0005 017 | | | | 0120 0700 017 | 0130 0705 017 | | |
| 18 | | 0120 8980 018 | 0130 0005 018 | | | | 0120 0700 018 | 0130 0705 018 | | |
| 19 | | 0120 8980 019 | 0130 0005 019 | 0140 0000 019 | | | 0120 0700 019 | 0130 0705 019 | 0140 0700 019 | |
| 20 | | 0120 8980 020 | 0130 0005 020 | 0140 0000 020 | | | 0120 0700 020 | 0130 0705 020 | 0140 0700 020 | |
| 21 | | 0120 8980 021 | 0130 0005 021 | 0140 0000 021 | | | 0120 0700 021 | 0130 0705 021 | 0140 0700 021 | |
| 22 | | 0120 8980 022 | 0130 0005 022 | 0140 0000 022 | | | 0120 0700 022 | 0130 0705 022 | 0140 0700 022 | |
| 23 | | 0120 8980 023 | 0130 0005 023 | 0140 0000 023 | | | 0120 0700 023 | 0130 0705 023 | 0140 0700 023 | |
| 24 | | 0120 8980 024 | 0130 0005 024 | 0140 0000 024 | | | 0120 0700 024 | 0130 0705 024 | 0140 0700 024 | |
| 25 | | 0120 8980 025 | 0130 0005 025 | 0140 0000 025 | | | 0120 0700 025 | 0130 0705 025 | 0140 0700 025 | |
| 26 | | 0120 8980 026 | 0130 0005 026 | 0140 0000 026 | | | 0120 0700 026 | 0130 0705 026 | 0140 0700 026 | |
| 27 | | 0120 8980 027 | 0130 0005 027 | 0140 0000 027 | | | 0120 0700 027 | 0130 0705 027 | 0140 0700 027 | |
| 28 | | 0120 8980 028 | 0130 0005 028 | 0140 0000 028 | | | 0120 0700 028 | 0130 0705 028 | 0140 0700 028 | |
| 29 | | 0120 8980 029 | 0130 0005 029 | 0140 0000 029 | | | 0120 0700 029 | 0130 0705 029 | 0140 0700 029 | |
| 30 | | 0120 8980 030 | 0130 0005 030 | 0140 0000 030 | 0150 0000 030 | | 0120 0700 030 | 0130 0705 030 | 0140 0700 030 | 0150 0700 030 |
| 31 | | 0120 8980 031 | 0130 0005 031 | 0140 0000 031 | 0150 0000 031 | | | 0130 0705 031 | 0140 0700 031 | 0150 0700 031 |
| 32 | | 0120 8980 032 | 0130 0005 032 | 0140 0000 032 | 0150 0000 032 | | | 0130 0705 032 | 0140 0700 032 | 0150 0700 032 |
| 33 | | | | 0140 0000 033 | 0150 0000 033 | | | 0130 0705 033 | 0140 0700 033 | 0150 0700 033 |
| 34 | | | | 0140 0000 034 | 0150 0000 034 | | | 0130 0705 034 | 0140 0700 034 | 0150 0700 034 |
| 35 | | | | 0140 0000 035 | 0150 0000 035 | | | 0130 0705 035 | 0140 0700 035 | 0150 0700 035 |
| 36 | | | | 0140 0000 036 | 0150 0000 036 | | | | 0140 0700 036 | 0150 0700 036 |
| 37 | | | | | 0150 0000 037 | | | | 0140 0700 037 | 0150 0700 037 |
| 38 | | | | | 0150 0000 038 | | | | 0140 0700 038 | 0150 0700 038 |

Additional diameters available on request.

Available in W4 on request.

Available in 25 mm and 30 mm band width on request.

| NORMACLAMP® S | | | | | | | | | | |
|-----------------------|----------------|---------|----------|----------|---------------|----------------|---------|----------|---------------|---------------|
| Clamping diameter, mm | W1 Product No. | | | | | W5 Product No. | | | | |
| | Band width | | | | | Band width | | | | |
| | 7 mm Zy | 9 mm Zy | 12 mm Sz | 15 mm Sz | 20 mm Sz | 7 mm Zy | 9 mm Zy | 12 mm Sz | 15 mm Sz | 20 mm Sz |
| 39 | | | | | 0150 0000 039 | | | | 0140 0700 039 | 0150 0700 039 |
| 40 | | | | | 0150 0000 040 | | | | 0140 0700 040 | 0150 0700 040 |
| 41 | | | | | 0150 0000 041 | | | | | 0150 0700 041 |
| 42 | | | | | 0150 0000 042 | | | | | 0150 0700 042 |
| 43 | | | | | 0150 0000 043 | | | | | 0150 0700 043 |
| 44 | | | | | 0150 0000 044 | | | | | 0150 0700 044 |
| 45 | | | | | 0150 0000 045 | | | | | 0150 0700 045 |
| 46 | | | | | 0150 0000 046 | | | | | 0150 0700 046 |
| 47 | | | | | 0150 0000 047 | | | | | 0150 0700 047 |
| 48 | | | | | 0150 0000 048 | | | | | 0150 0700 048 |
| 49 | | | | | 0150 0000 049 | | | | | 0150 0700 049 |
| 50 | | | | | 0150 0000 050 | | | | | 0150 0700 050 |
| 51 | | | | | 0150 0000 051 | | | | | 0150 0700 051 |
| 52 | | | | | 0150 0000 052 | | | | | 0150 0700 052 |
| 53 | | | | | 0150 0000 053 | | | | | 0150 0700 053 |
| 54 | | | | | 0150 0000 054 | | | | | 0150 0700 054 |
| 55 | | | | | 0150 0000 055 | | | | | 0150 0700 055 |
| 56 | | | | | 0150 0000 056 | | | | | 0150 0700 056 |
| 57 | | | | | 0150 0000 057 | | | | | 0150 0700 057 |
| 58 | | | | | 0150 0000 058 | | | | | 0150 0700 058 |
| 59 | | | | | 0150 0000 059 | | | | | 0150 0700 059 |
| 60 | | | | | 0150 0000 060 | | | | | 0150 0700 060 |
| 61 | | | | | 0150 0000 061 | | | | | 0150 0700 061 |
| 62 | | | | | 0150 0000 062 | | | | | 0150 0700 062 |
| 63 | | | | | 0150 0000 063 | | | | | 0150 0700 063 |
| 64 | | | | | 0150 0000 064 | | | | | 0150 0700 064 |
| 65 | | | | | 0150 0000 065 | | | | | 0150 0700 065 |
| 66 | | | | | 0150 0000 066 | | | | | 0150 0700 066 |
| 67 | | | | | 0150 0000 067 | | | | | 0150 0700 067 |
| 68 | | | | | 0150 0000 068 | | | | | 0150 0700 068 |
| 69 | | | | | 0150 0000 069 | | | | | 0150 0700 069 |
| 70 | | | | | 0150 0000 070 | | | | | 0150 0700 070 |
| 71 | | | | | 0150 0000 071 | | | | | |
| 72 | | | | | 0150 0000 072 | | | | | |
| 73 | | | | | 0150 0000 073 | | | | | |
| 74 | | | | | 0150 0000 074 | | | | | |
| 75 | | | | | 0150 0000 075 | | | | | |
| 76 | | | | | 0150 0000 076 | | | | | |
| 77 | | | | | 0150 0000 077 | | | | | |
| 78 | | | | | 0150 0000 078 | | | | | |
| 79 | | | | | 0150 0000 079 | | | | | |
| 80 | | | | | 0150 0000 080 | | | | | |
| 81 | | | | | 0150 0000 081 | | | | | |
| 82 | | | | | 0150 0000 082 | | | | | |
| 83 | | | | | 0150 0000 083 | | | | | |
| 84 | | | | | 0150 0000 084 | | | | | |
| 85 | | | | | 0150 0000 085 | | | | | |
| 86 | | | | | 0150 0000 086 | | | | | |
| 87 | | | | | 0150 0000 087 | | | | | |
| 88 | | | | | 0150 0000 088 | | | | | |

Additional diameters available on request.
 Available in W4 on request.
 Available in 25 mm and 30 mm band width on request.

| NORMACLAMP® S | | | | | | | | | | |
|-----------------------|----------------|---------|----------|----------|---------------|----------------|---------|----------|----------|----------|
| Clamping diameter, mm | W1 Product No. | | | | | W5 Product No. | | | | |
| | Band width | | | | | Band width | | | | |
| | 7 mm Zy | 9 mm Zy | 12 mm Sz | 15 mm Sz | 20 mm Sz | 7 mm Zy | 9 mm Zy | 12 mm Sz | 15 mm Sz | 20 mm Sz |
| 89 | | | | | 0150 0000 089 | | | | | |
| 90 | | | | | 0150 0000 090 | | | | | |
| 91 | | | | | 0150 0000 091 | | | | | |
| 92 | | | | | 0150 0000 092 | | | | | |
| 93 | | | | | 0150 0000 093 | | | | | |
| 94 | | | | | 0150 0000 094 | | | | | |
| 95 | | | | | 0150 0000 095 | | | | | |
| 96 | | | | | 0150 0000 096 | | | | | |
| 97 | | | | | 0150 0000 097 | | | | | |
| 98 | | | | | 0150 0000 098 | | | | | |
| 99 | | | | | 0150 0000 099 | | | | | |
| 100 | | | | | 0150 0000 100 | | | | | |
| 101 | | | | | 0150 0000 101 | | | | | |
| 102 | | | | | 0150 0000 102 | | | | | |
| 103 | | | | | 0150 0000 103 | | | | | |
| 104 | | | | | 0150 0000 104 | | | | | |
| 105 | | | | | 0150 0000 105 | | | | | |
| 106 | | | | | 0150 0000 106 | | | | | |
| 107 | | | | | 0150 0000 107 | | | | | |
| 108 | | | | | 0150 0000 108 | | | | | |
| 109 | | | | | 0150 0000 109 | | | | | |
| 110 | | | | | 0150 0000 110 | | | | | |
| 111 | | | | | 0150 0000 111 | | | | | |
| 112 | | | | | 0150 0000 112 | | | | | |
| 113 | | | | | 0150 0000 113 | | | | | |
| 114 | | | | | 0150 0000 114 | | | | | |
| 115 | | | | | 0150 0000 115 | | | | | |
| 116 | | | | | 0150 0000 116 | | | | | |
| 117 | | | | | 0150 0000 117 | | | | | |
| 118 | | | | | 0150 0000 118 | | | | | |
| 119 | | | | | 0150 0000 119 | | | | | |
| 120 | | | | | 0150 0000 120 | | | | | |

Additional diameters available on request.
 Available in W4 on request.
 Available in 25 mm and 30 mm band width on request.

SP Single



NORMACLAMP® SP Single is suitable for attaching rubber and plastic hoses as well as rubber sleeves to pipe ends or hose spigots. This clamp can be used for clamping containers, pipes and cables.

Materials

W1, W5 on request

SP Double



NORMACLAMP® SP Double enables larger diameters to be clamped easily thanks to its multi-part design.

Materials

W1, W5 on request

SPGU



NORMACLAMP® SPGU has a rubber profile that protects against vibration and creeping water. It is also sound-absorbent and protects against contact corrosion.

Materials

W1, W5 on request

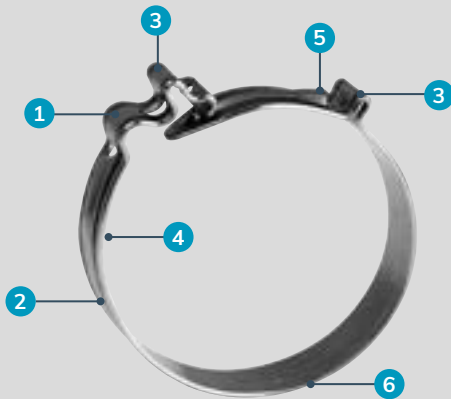

- 1 Self-adjusting diameter**
- compensation for tolerances at the outer diameter of the hose
- 2 Color coding**
- a rapid way of visually distinguishing between nominal diameters
- 3 Protruding tool gripping points**
- easy and safe installation
- 4 Date of manufacture and machine number indicated**
- 5 Single lock-in point**
- installation indicator for easy visual checking
- 6 Band material with rounded outer edges**
- hose protection

One-piece hose clips

NORMACLAMP® COBRA products are bolt-free, one-piece hose clips. Their low overall height enables precise installation in even the tightest of spaces. NORMACLAMP® COBRA clamps are quick and easy to install.



Advantages at a glance

- ✓ Bolt-free hose clip in one piece
- ✓ Quick, easy and safe installation
- ✓ Maintenance-free fit

Applications

- Machine building
- White goods
- Chemical industry
- Irrigation systems
- Food and beverage industry
- Agricultural machines
- Engine manufacturing
- Pump and filter
- Suction lines
- Ventilation lines
- Washing machine hoses
- Pneumatic lines

Materials

| | | | | |
|----|----|----|----|----|
| W1 | W2 | W3 | W4 | W5 |
| | | | x | |

| Material | Corrosion resistance in salt spray testing |
|----------|--|
| W4 | Min. 240 h |

Selecting the right nominal diameter

Push the hose onto the spigot and measure the outer diameter D_o .

The applicable nominal diameter d_1 is then matched to this outer diameter D_o .

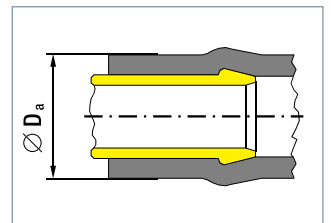

If required, we can send you an appropriate sample before you place your order.

If you have any additional, application-specific questions, we will be happy to advise you in more detail.

Technical data & Ordering information

| NORMACLAMP® COBRA | | | | | | |
|-------------------|--------------|-----------------|---------------|------------------|----------------|--------|
| Width | Designation | Clamping ranges | | Nominal diameter | W4 Product No. | Color |
| | | in mm | in inches | | | |
| 7 | COBRA 7.5/7 | 8-9 | 5/16-3/8" | 7.5 | 0107 7000 075 | White |
| | COBRA 8.0/7 | 8.5-9.5 | 5/16-3/8" | 8.0 | 0107 7000 008 | Yellow |
| | COBRA 8.5/7 | 9-10 | 3/8-3/8" | 8.5 | 0107 7000 085 | Green |
| | COBRA 9.0/7 | 9.5-10.5 | 3/8-3/8" | 9.0 | 0107 7000 009 | Purple |
| | COBRA 9.5/7 | 10-11 | 3/8-7/16" | 9.5 | 0107 7000 095 | Black |
| | COBRA 10.0/7 | 10.5-11.5 | 3/8-7/16" | 10 | 0107 7000 010 | White |
| | COBRA 10.5/7 | 11-12 | 7/16-1/2" | 10.5 | 0107 7000 105 | Yellow |
| | COBRA 11.0/7 | 11.5-12.5 | 7/16-1/2" | 11 | 0107 7000 011 | Green |
| | COBRA 11.5/7 | 12-13 | 1/2-1/2" | 11.5 | 0107 7000 115 | Purple |
| 8 | COBRA 12/8 | 12.5-14 | 1/2-9/16" | 12 | 0108 7006 012 | Black |
| | COBRA 13/8 | 13.5-15 | 1/2-5/8" | 13 | 0108 7006 013 | Yellow |
| | COBRA 14/8 | 14.5-16 | 9/16-5/8" | 14 | 0108 7006 014 | Purple |
| | COBRA 15/8 | 15.5-17 | 5/8-11/16" | 15 | 0108 7006 015 | White |
| | COBRA 16/8 | 16.5-18 | 5/8-3/4" | 16 | 0108 7006 016 | Green |
| | COBRA 17/8 | 17.5-19 | 11/16-3/4" | 17 | 0108 7006 017 | Black |
| | COBRA 18/8 | 18.5-20 | 3/4-13/16" | 18 | 0108 7006 018 | Yellow |
| | COBRA 19/8 | 19.5-21 | 3/4-13/16" | 19 | 0108 7006 019 | Purple |
| | COBRA 20/8 | 20.5-22 | 13/16-7/8" | 20 | 0108 7006 020 | White |
| | COBRA 21/8 | 21.5-23 | 13/16-7/8" | 21 | 0108 7006 021 | Green |
| | COBRA 22/8 | 22.5-24 | 7/8-15/16" | 22 | 0108 7006 022 | Black |
| | COBRA 23/8 | 23.5-25 | 7/8-1" | 23 | 0108 7006 023 | Yellow |
| | COBRA 24/8 | 24.5-26 | 15/16-1 1/16" | 24 | 0108 7006 024 | Purple |
| | COBRA 25/8 | 25.5-27 | 1-1 1/16" | 25 | 0108 7006 025 | White |
| | COBRA 26/8 | 26.5-28 | 1 1/16-1 1/8" | 26 | 0108 7006 026 | Green |
| | COBRA 27/8 | 27.5-29 | 1 1/16-1 1/8" | 27 | 0108 7006 027 | Black |
| | COBRA 28/8 | 28.5-30 | 1 1/8-1 3/16" | 28 | 0108 7006 028 | Yellow |
| | COBRA 29/8 | 29.5-31 | 1 1/8-1 1/4" | 29 | 0108 7006 029 | Purple |
| | COBRA 30/8 | 30.5-32 | 1 3/16-1 1/4" | 30 | 0108 7006 030 | White |

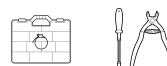

Refer to pages 187, 191 and 193

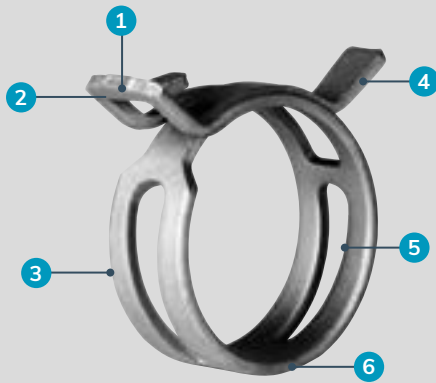

- 1 Lot number stamped on**
- reliable traceability
- 2 NORMA® logo**
- a visible sign of quality
- 3 Base and Topcoat Coating System**
- double layered chromium VI-free coating
- provides optimum corrosion and chemical protection
- 4 Nominal diameter stamped on**
- prevents mistakes
- 5 Special design**
- even distribution of clamping force and excellent roundness
- 6 Rounded band edges**
- optimum hose protection

Springband hose clamps in acc. with DIN 3021

NORMACLAMP® FBS springband hose clamps are the perfect choice for hose spigot systems that are exposed to significant temperature fluctuations. Once installed, their dynamic spring properties ensure an automatic re-tensioning effect over long periods of time. Even at low temperatures, this mechanism still enables sufficiently high levels of radial clamping force to be achieved, which in turn ensures excellent sealing reliability. With NORMACLAMP® FBS clamps even hoses that have a tendency to “creep” can be joined securely. Manual or pneumatic tools are used for professional installation.

Advantages at a glance

- ✓ One-piece, bolt-free hose clamp
- ✓ Even distribution of clamping force
- ✓ Optimum roundness
- ✓ Temperature resistance from -40 °C to 200 °C
- ✓ Automatically re-tensions to accommodate temperature fluctuations
- ✓ Clear traceability due to batch numbering

Applications

- Machine building
- White goods
- Agricultural machines
- Engine manufacturing
- Cooling and heating water circuits
- Fuel vent system
- Air ducts
- Water and brine outlet lines

Short description

- Dynamic clamp
- Band material C 75 S
- Coating containing zinc; no chromium (VI)
- Nominal diameter of 13 – 70 mm in various graduations

Materials

| Material | Zinc/aluminum coating | Organic coating |
|---|-----------------------|-----------------|
| C 75 S | Base coat | Topcoat |
| Corrosion resistance in salt spray testing | | |
| Up to 720 h according to DIN EN ISO 9227 | | |

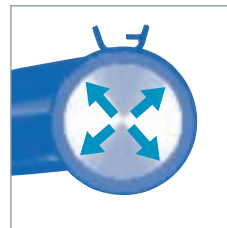

At high temperatures

- Hose diameter increases
- FBS adapts to internal pressure

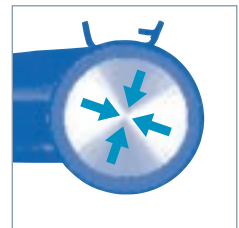

At low temperatures

- Hose diameter decreases
- FBS re-tensions
- Clamping force is retained and clamp provides perfect seal

Determine clamp size

To determine which clamp is right for you, follow these steps:

1. Push the hose onto the spigot and measure $D_{min.}$ and $D_{max.}$
2. Based on the $D_{min.}$ value, determine the nominal diameter (D_n) of the clamp in question. $D_n = D_{min.}$
3. Compare the $D_{max.}$ value with the minimum diameter ($D_{0 min.}$) specified for the open clamp and select the clamp that is appropriate. $D_{0 min.} \geq D_{max.}$

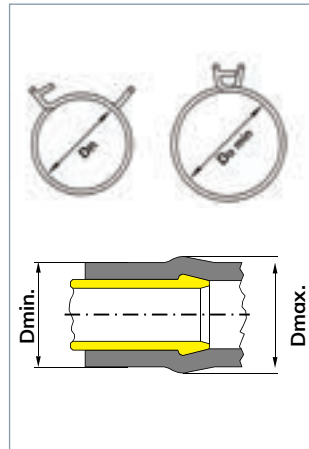

If required, we can send you an appropriate sample before you place your order. If you have any additional, application-specific questions, we will be happy to advise you in more detail.

Technical data & Ordering information

| NORMACLAMP® FBS STANDARD | | | | | | | |
|--------------------------|-------------|-------------|--------------------|------------------|------------------------|--------------------------------|---------------|
| Width | Designation | D_n mm | D_n in inches | D_o m in mm | D_o min in inches | Material C 75 S Product No. | |
| | | | | | | Black | Silver |
| 12 | FBS 13/12 | 13 | 1/2" | 14.5 | 9/16" | 0112 8024 013 | 0112 8074 013 |
| | FBS 14/12 | 14 | 9/16" | 15.8 | 5/8" | 0112 8024 014 | 0112 8074 014 |
| | FBS 15/12 | 15 | 9/16" | 16.8 | 11/16" | 0112 8024 015 | 0112 8074 015 |
| | FBS 16/12 | 16 | 5/8" | 17.5 | 11/16" | 0112 8024 016 | 0112 8074 016 |
| | FBS 17/12 | 17 | 11/16" | 18.5 | 3/4" | 0112 8024 017 | 0112 8074 017 |
| | FBS 18/12 | 18 | 11/16" | 19 | 3/4" | 0112 8024 018 | 0112 8074 018 |
| | FBS 19/12 | 19 | 3/4" | 21 | 13/16" | 0112 8024 019 | 0112 8074 019 |
| | FBS 20/12 | 20 | 13/16" | 21.6 | 7/8" | 0112 8024 020 | 0112 8074 020 |
| | FBS 21/12 | 21 | 13/16" | 22.5 | 7/8" | 0112 8024 021 | 0112 8074 021 |
| | FBS 22/12 | 22 | 7/8" | 24.5 | 15/16" | 0112 8024 022 | 0112 8074 022 |
| | FBS 23/12 | 23 | 15/16" | 24.7 | 1" | 0112 8024 023 | 0112 8074 023 |
| | FBS 24/12 | 24 | 15/16" | 26 | 1" | 0112 8024 024 | 0112 8074 024 |
| | FBS 25/12 | 25 | 1" | 27 | 1 1/16" | 0112 8024 025 | 0112 8074 025 |
| | FBS 26/12 | 26 | 1" | 28 | 1 1/8" | 0112 8024 026 | 0112 8074 026 |
| | FBS 27/12 | 27 | 1 1/16" | 29 | 1 1/8" | 0112 8024 027 | 0112 8074 027 |
| | FBS 28/12 | 28 | 1 1/8" | 30.5 | 1 3/16" | 0112 8024 028 | 0112 8074 028 |
| | FBS 29/12 | 29 | 1 1/8" | 31.5 | 1 1/4" | 0112 8024 029 | 0112 8074 029 |
| | FBS 30/12 | 30 | 1 3/16" | 32.5 | 1 1/4" | 0112 8024 030 | 0112 8074 030 |
| | FBS 32/12 | 32 | 1 1/4" | 34.5 | 1 3/8" | 0112 8024 032 | 0112 8074 032 |
| | FBS 35/12 | 35 | 1 3/8" | 38 | 1 1/2" | 0112 8024 035 | 0112 8074 035 |
| | FBS 36/12 | 36 | 1 7/16" | 39 | 1 9/16" | 0112 8024 036 | 0112 8074 036 |
| | FBS 38/12 | 38 | 1 1/2" | 41.5 | 1 5/8" | 0112 8024 038 | 0112 8074 038 |
| | FBS 40/12 | 40 | 1 9/16" | 42.5 | 1 11/16" | 0112 8024 040 | 0112 8074 040 |
| | FBS 42/12 | 42 | 1 5/8" | 44.5 | 1 3/4" | 0112 8024 042 | 0112 8074 042 |
| | FBS 44/12 | 44 | 1 3/4" | 46.5 | 1 13/16" | 0112 8024 044 | 0112 8074 044 |
| | FBS 46/12 | 46 | 1 13/16" | 49 | 1 15/16" | 0112 8024 046 | 0112 8074 046 |
| | FBS 47/12 | 47 | 1 7/8" | 50 | 2" | 0112 8024 047 | 0112 8074 047 |
| | FBS 50/12 | 50 | 2" | 53 | 2 1/16" | 0112 8024 050 | 0112 8074 050 |
| | FBS 55/12 | 55 | 2 3/16" | 58 | 2 1/4" | 0112 8024 055 | 0112 8074 055 |
| | FBS 60/12 | 60 | 2 3/8" | 63 | 2 1/2" | 0112 8024 060 | 0112 8074 060 |

Special diameters available on request



Refer to pages 191 and 194

FBS – VERSIONS

FBS R



The NORMACLAMP® FBS R was designed with the aim of achieving the smallest overall height that was technically possible so that it could be used in difficult installation conditions.

Main advantage

Space-saving clamp

Material

C75S



Refer to pages 191 and 194

FBS C



A pre-opened clamp that must be glued into place on the hose. Ask your sales representative for the gluing instructions. The retaining mechanism for this version is part of the band and is integrated into the clamp.

Advantages at a glance

- Pre-assembled clamp
- Ready to use

Material

C75S



Refer to page 191

FBS HC



A pre-opened version that is secured by a plastic clip and can also be glued into place on the hose. Ask your Sales Representative for gluing instructions. Once the clamp has been pushed onto the hose, this clip can be released easily by hand.

Main advantage

Easy to assemble

Material

C75S

FBS MC



A pre-opened version that is secured by a metal clip and can also be glued into place on the hose. Ask your Sales Representative for gluing instructions. The retaining clip for this version is removed by using pliers.

Main advantage

Secured clamp

Material

C75S

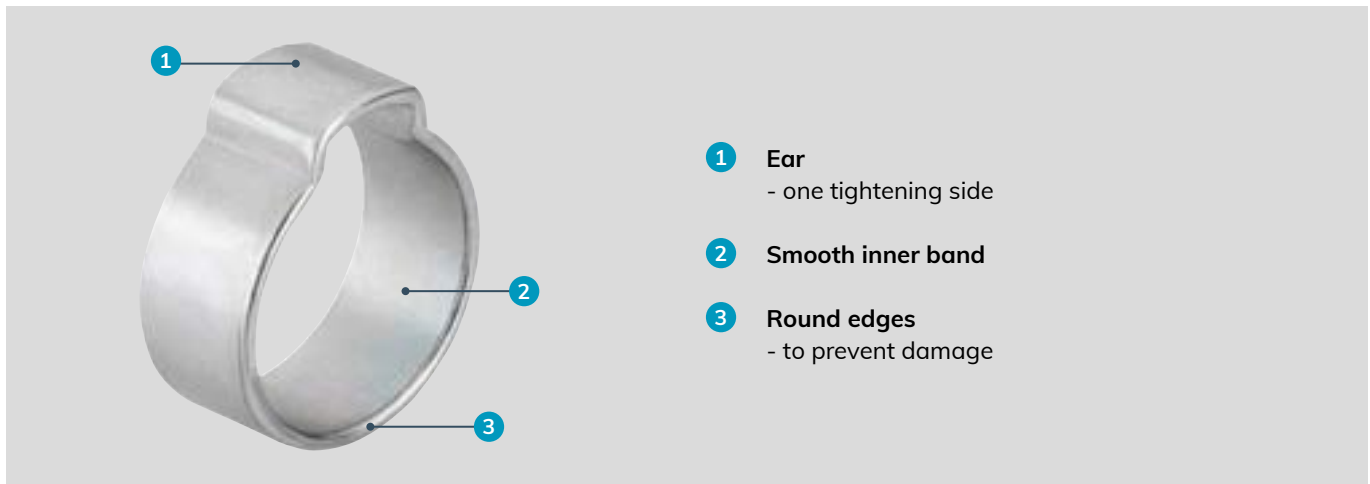

- 1 Ear**
- one tightening side
- 2 Smooth inner band**
- 3 Round edges**
- to prevent damage

One part clamp for low and medium pressure

The NORMACLAMP® Ear Clip Single has no screw. The assembly is fast, simple and safe thanks to the pinching of the ear.

Advantages at a glance

- ✓ Cost effective, and simple alternative to worm drive hose clips
- ✓ Fast and easy to install
- ✓ Ideal in narrow spaces
- ✓ Suitable for definitive fixation of connecting pipes
- ✓ To be assembled with simple ear clip pliers

Applications

- For hoses that convey compressed air or fluid
- Original equipment manufacturing
- Maintenance repair and overhaul

Materials

| | | | | |
|----|----|----|----|----|
| W1 | W2 | W3 | W4 | W5 |
| x | | | x | |

Technical data & Ordering information

| NORMACLAMP® EAR CLIP SINGLE | | | | | |
|-----------------------------|--------------------------------|-----------------|------------|-------------------|-------------------|
| Width | Description | Clamping ranges | | W1 Product No. | W4 Product No. |
| | | in mm | in inches | | |
| 6 | EAR CLIP SINGLE 8 - 10/6 | 8 - 10 | 5/16-3/8" | 0110 7010 010 | 0110 7011 010 |
| | EAR CLIP SINGLE 9 - 11/6.5 | 9 - 11 | 3/8-7/16" | 0110 7010 011 | 0110 7011 011 |
| 6.5 | EAR CLIP SINGLE 10 - 12/6.5 | 10 - 12 | 3/8-1/2" | 0110 7010 012 | 0110 7011 012 |
| | EAR CLIP SINGLE 11 - 13/6.5 | 11 - 13 | 7/16-1/2" | 0110 7010 013 | 0110 7011 013 |
| 7 | EAR CLIP SINGLE 12 - 14/7 | 12 - 14 | 1/2-9/16" | 0110 7010 014 | 0110 7011 014 |
| | EAR CLIP SINGLE 13 - 15/7 | 13 - 15 | 1/2-9/16" | | 0110 7011 015 |
| | EAR CLIP SINGLE 14 - 16/7 | 14 - 16 | 9/16-5/8" | 0110 7010 016 | 0110 7011 016 |
| | EAR CLIP SINGLE 16 - 18/7 | 16 - 18 | 5/8-11/16" | 0110 7010 018 | 0110 7011 018 |



Refer to page 193

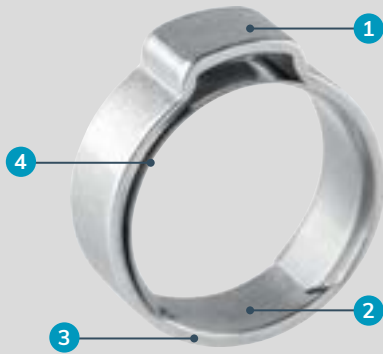

- 1 Ear**
- one tightening side
- 2 Smooth inner band and inner liner**
- for security and roundness
- 3 Round edges**
- to prevent damage
- 4 Inner liner**
- effective and powerful all-round seal

One part clamp for low and medium pressure

The NORMACLAMP® Ear Clip Safe has no screw. The assembly is fast, simple and safe thanks to the pinching of the ear. The inner insert allows a better distribution of the clamping force.

Advantages at a glance

- ✓ Cost effective, and simple alternative to worm drive hose clips
- ✓ Fast and easy to install
- ✓ Ideal in narrow spaces
- ✓ Suitable for definitive fixation of connecting pipes
- ✓ To be assembled with simple ear clip pliers
- ✓ Inner liner for security and better distribution of the clamping force

Applications

- For hoses that convey compressed air or fluid
- Original equipment manufacturing
- Maintenance repair and overhaul

Materials

| W1 | W2 | W3 | W4 | W5 |
|----|----|----|----|----|
| x | | | x | |

Technical data & Ordering information

| NORMACLAMP® EAR CLIP SAFE | | | | | |
|---------------------------|-----------------------------|-----------------|-------------|----------------|----------------|
| Width in mm | Description | Clamping ranges | | W1 Product No. | W4 Product No. |
| | | in mm | in inches | | |
| 6 | EAR CLIP SAFE 7.5-8.5/6 | 7.5-8.5 | 5/16-5/16" | 0110 7014 008 | 0110 7015 008 |
| | EAR CLIP SAFE 8-9.5/6 | 8-9.5 | 5/16-3/8" | 0110 7014 009 | 0110 7015 009 |
| 6.5 | EAR CLIP SAFE 9-10.5/6.5 | 9-10.5 | 3/8-7/16" | 0110 7014 010 | 0110 7015 010 |
| | EAR CLIP SAFE 10-11.5/6.5 | 10-11.5 | 3/8-7/16" | 0110 7014 011 | 0110 7015 011 |
| | EAR CLIP SAFE 10.5-12.5/6.5 | 10.5-12.5 | 7/16-1/2" | 0110 7014 012 | 0110 7015 012 |
| 7 | EAR CLIP SAFE 11.5-13.3/7 | 11.5-13.3 | 7/16-1/2" | 0110 7014 013 | 0110 7015 013 |
| | EAR CLIP SAFE 12.5-14.5/7 | 12.5-14.5 | 1/2-9/16" | | 0110 7015 014 |
| | EAR CLIP SAFE 13-15.3/7 | 13-15.3 | 1/2-5/8" | 0110 7014 015 | 0110 7015 015 |
| | EAR CLIP SAFE 14-16/7 | 14-16 | 9/16-1/4" | | 0110 7015 016 |
| | EAR CLIP SAFE 15-17.3/7 | 15-17.3 | 9/16-11/16" | 0110 7014 017 | 0110 7015 017 |
| 7.5 | EAR CLIP SAFE 16-18.3/7.5 | 16-18.3 | 1/4-3/4" | | 0110 7015 018 |
| | EAR CLIP SAFE 17-19.3/7.5 | 17-19.3 | 11-16-3/4" | | 0110 7015 019 |

Refer to page 193 

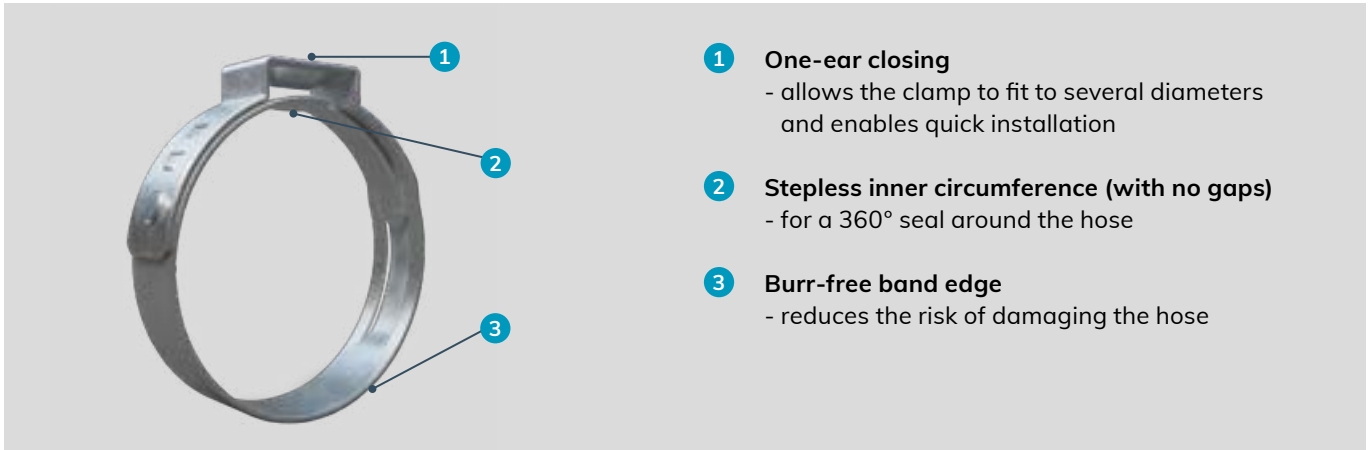

- 1 One-ear closing**
- allows the clamp to fit to several diameters and enables quick installation
- 2 Stepless inner circumference (with no gaps)**
- for a 360° seal around the hose
- 3 Burr-free band edge**
- reduces the risk of damaging the hose

Ear clip with 360° uniform compression sealing

NORMACLAMP® Ear Clip Pro³⁶⁰ has no steps or gaps on the inner circle of the clamp, thus enabling a 360° seal on the hose. Thanks to the bolt-free design the clamp can be installed precisely in tight spaces.

Advantages at a glance

- ✓ 360° seal on the hose
- ✓ Quick installation
- ✓ Low profile for tight spaces
- ✓ Burr-free band edge

Applications

Ear Clip Pro³⁶⁰ is well suited to applications involving poly and braided tubing that require a complete seal, e.g. for:

- Automotive aftermarket
- White goods industry
- Food & beverage industry

Materials

| W1 | W2 | W3 | W4 | W5 |
|----|----|----|----|----|
| | | | x | |

Technical drawing

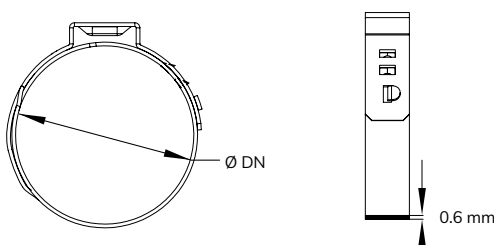

Technical data & Ordering information

| NORMACLAMP® EAR CLIP PRO360 | | | |
|-----------------------------|------------------------------|-----------|----------------|
| Width in mm | Designation | Ø DN (mm) | W4 Product No. |
| 5 | Ear Clip Pro360 6.8-8.0 W4 | 6.8-8.0 | 0110 7245 080 |
| | Ear Clip Pro360 7.3-9.0 W4 | 7.3-9.0 | 0110 7245 090 |
| | Ear Clip Pro360 7.8-9.5 W4 | 7.8-9.5 | 0110 7245 095 |
| | Ear Clip Pro360 8.8-10.5 W4 | 8.8-10.5 | 0110 7245 105 |
| | Ear Clip Pro360 9.6-11.3 W4 | 9.6-11.3 | 0110 7245 113 |
| 7 | Ear Clip Pro360 9.8-12.3 W4 | 9.8-12.3 | 0110 7247 123 |
| | Ear Clip Pro360 10.3-12.8 W4 | 10.3-12.8 | 0110 7247 128 |
| | Ear Clip Pro360 10.8-13.3 W4 | 10.8-13.3 | 0110 7247 133 |
| | Ear Clip Pro360 11.3-13.8 W4 | 11.3-13.8 | 0110 7247 138 |
| | Ear Clip Pro360 12.0-14.5 W4 | 12.0-14.5 | 0110 7247 145 |
| | Ear Clip Pro360 13.2-15.7 W4 | 13.2-15.7 | 0110 7247 157 |
| | Ear Clip Pro360 13.5-16.0 W4 | 13.5-16.0 | 0110 7247 160 |
| | Ear Clip Pro360 14.3-16.8 W4 | 14.3-16.8 | 0110 7247 168 |
| | Ear Clip Pro360 15.0-17.5 W4 | 15.0-17.5 | 0110 7247 175 |
| | Ear Clip Pro360 15.3-18.5 W4 | 15.3-18.5 | 0110 7247 185 |
| | Ear Clip Pro360 16.6-19.8 W4 | 16.6-19.8 | 0110 7247 198 |
| | Ear Clip Pro360 17.8-21.0 W4 | 17.8-21.0 | 0110 7247 210 |
| | Ear Clip Pro360 19.4-22.6 W4 | 19.4-22.6 | 0110 7247 226 |
| | Ear Clip Pro360 22.4-25.6 W4 | 22.4-25.6 | 0110 7247 256 |
| | Ear Clip Pro360 23.9-27.1 W4 | 23.9-27.1 | 0110 7247 271 |
| | Ear Clip Pro360 25.4-28.6 W4 | 25.4-28.6 | 0110 7247 286 |
| | Ear Clip Pro360 28.4-31.6 W4 | 28.4-31.6 | 0110 7247 316 |
| | Ear Clip Pro360 29.9-33.1 W4 | 29.9-33.1 | 0110 7247 331 |

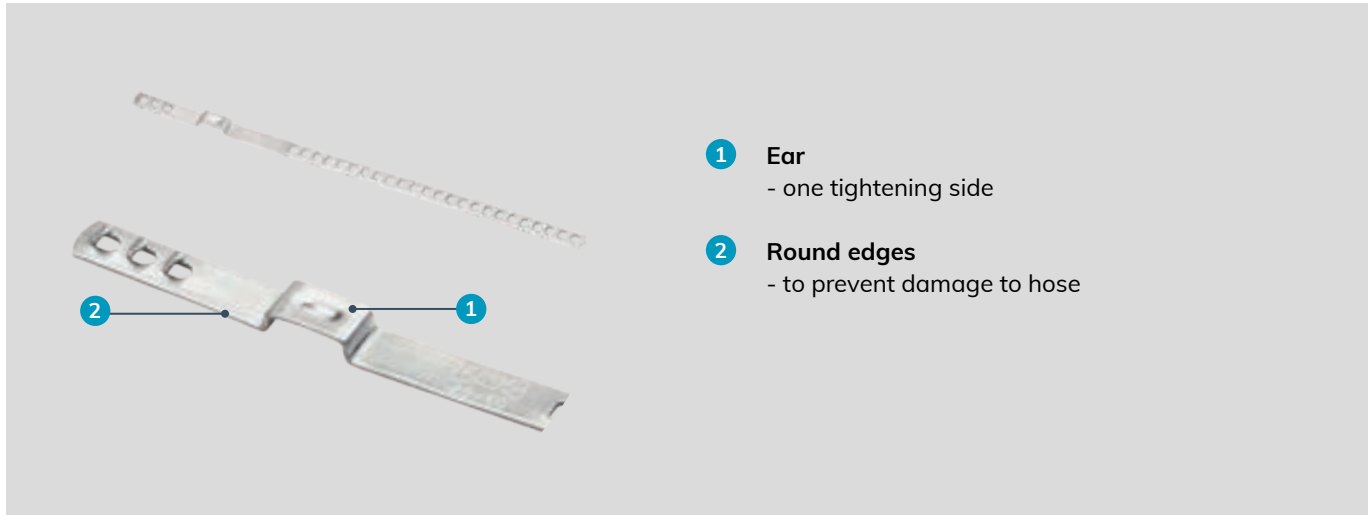

- 1 **Ear**
- one tightening side
- 2 **Round edges**
- to prevent damage to hose

Flexible clamp to mount different sizes of rubber boots

The NORMACLAMP® CV Boot Clamp has no screws. The assembly is fast and reliable, thanks to pinching of the ear.

Advantages at a glance

- ✓ Clamps can be adjusted to several diameters
- ✓ Fast and easy installation
- ✓ Robust clamping due to 3 locking teeth

Applications

NORMACLAMP® CV Boot Clamps are used to mount various sizes of rubber boots on drive shafts in passenger and commercial vehicles.

Materials

| | | | | |
|----|----|----|----|----|
| W1 | W2 | W3 | W4 | W5 |
| | | | x | |

Technical data & Ordering information

| NORMACLAMP® CV BOOT CLAMP | | | |
|---------------------------|------------------------------------|-----------------|----------------|
| Width in mm | Description | Clamping ranges | W4 Product No. |
| | | in mm | |
| 7 | CV Boot Clamp 25-50 (100 pcs x 1) | 25-50 | 0110 7016 050 |
| | CV Boot Clamp 40-120 (100 pcs x 1) | 40-120 | 0110 7016 120 |
| | CV Boot Clamp 25-50 (25 pcs x 4) | 25-50 | 0110 5016 050 |
| | CV Boot Clamp 40-120 (25 pcs x 4) | 40-120 | 0110 5016 120 |



Refer to page 193

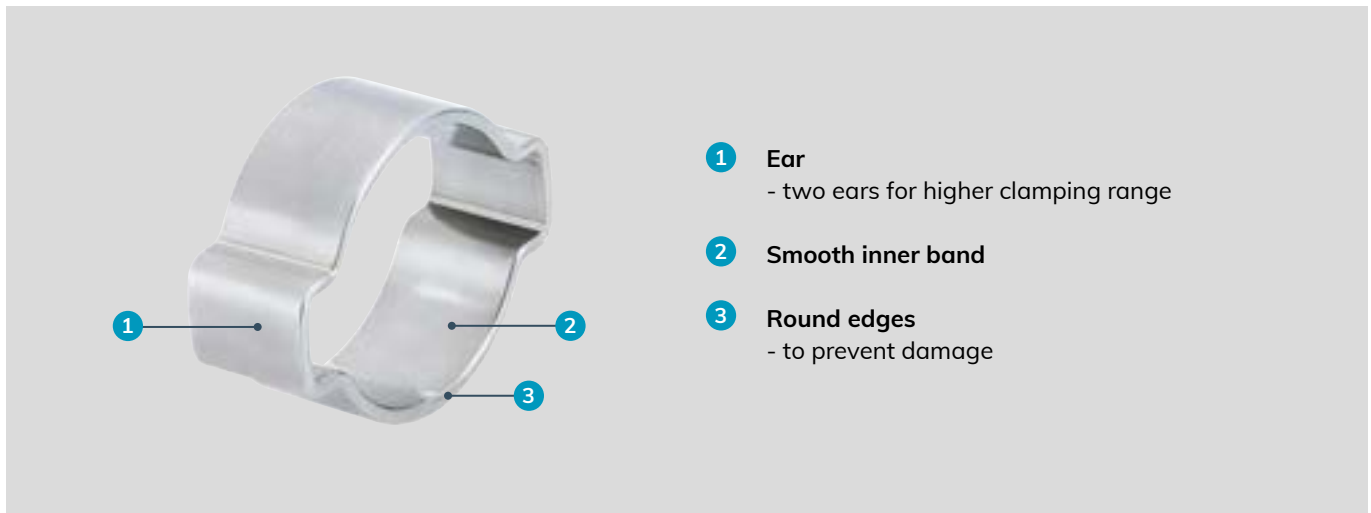

- 1 **Ear**
- two ears for higher clamping range
- 2 **Smooth inner band**
- 3 **Round edges**
- to prevent damage

One part clamp for low and medium pressure

The NORMACLAMP® Ear Clip Double has no screw. The assembly is fast, simple and safe thanks to the pinching of the ears. The two ears enable a better and more constant sealing force. The tightening force is improved.

Advantages at a glance

- ✓ Cost effective, and simple alternative to worm drive hose clips
- ✓ Fast and easy to install
- ✓ Ideal in narrow spaces
- ✓ Suitable for definitive fixation of connecting pipes
- ✓ To be assembled with simple ear clip pliers
- ✓ Extended clamping range

Applications

- For hoses that convey compressed air or fluid
- Original equipment manufacturing
- Maintenance repair and overhaul

Materials

| | | | | |
|----|----|----|----|----|
| W1 | W2 | W3 | W4 | W5 |
| x | | | x | |

EAR CLIP DOUBLE

Technical data & Ordering information

| NORMACLAMP® EAR CLIP DOUBLE | | | | | |
|-----------------------------|---------------------------|-----------------|------------------|----------------|----------------|
| Width in mm | Designation | Clamping ranges | | W1 Product No. | W4 Product No. |
| | | in mm | in inches | | |
| 6 | EAR CLIP DOUBLE 5-7/6 | 5-7 | 3/16-1/4" | 0110 7012 007 | 0110 7013 007 |
| | EAR CLIP DOUBLE 7-9/6 | 7-9 | 1/4-3/8" | 0110 7012 009 | 0110 7013 009 |
| 6.5 | EAR CLIP DOUBLE 9-11/6.5 | 9-11 | 3/8-7/16" | 0110 7012 011 | 0110 7013 011 |
| | EAR CLIP DOUBLE 10-12/6.5 | 10-12 | 3/8-1/2" | 0110 7012 012 | 0110 7013 012 |
| | EAR CLIP DOUBLE 11-13/6.5 | 11-13 | 7/16-1/2" | 0110 7012 013 | 0110 7013 013 |
| 7 | EAR CLIP DOUBLE 13-15/7 | 13-15 | 1/2-9/16" | 0110 7012 015 | 0110 7013 015 |
| | EAR CLIP DOUBLE 14-17/7 | 14-17 | 9/16-11/16" | 0110 7012 017 | 0110 7013 017 |
| 7.5 | EAR CLIP DOUBLE 15-18/7.5 | 15-18 | 9/16-11/16" | 0110 7012 018 | 0110 7013 018 |
| | EAR CLIP DOUBLE 17-20/7.5 | 17-20 | 11/16-13/16" | 0110 7012 020 | 0110 7013 020 |
| 8 | EAR CLIP DOUBLE 18-21/8 | 18-21 | 11/16-13/16" | 0110 7012 021 | 0110 7013 021 |
| | EAR CLIP DOUBLE 20-23/8 | 20-23 | 13/16-15/16" | 0110 7012 023 | 0110 7013 023 |
| 9 | EAR CLIP DOUBLE 22-25/9 | 22-25 | 7/8-1" | 0110 7012 025 | 0110 7013 025 |
| 10 | EAR CLIP DOUBLE 23-27/10 | 23-27 | 15/16-1 11/16" | 0110 7012 027 | |
| | EAR CLIP DOUBLE 25-28/10 | 25-28 | 1-1 1/8" | 0110 7012 028 | |
| | EAR CLIP DOUBLE 28-31/10 | 28-31 | 1 1/8-1 1/4" | 0110 7012 031 | |
| | EAR CLIP DOUBLE 31-34/10 | 31-34 | 1 1/4-1 5/16" | 0110 7012 034 | |
| | EAR CLIP DOUBLE 34-37/10 | 34-37 | 1 5/16-1 7/16" | 0110 7012 037 | |
| | EAR CLIP DOUBLE 37-40/10 | 37-40 | 1 7/16-1 9/16" | 0110 7012 040 | |
| | EAR CLIP DOUBLE 40-43/10 | 40-43 | 1 9/16-1 11/16" | 0110 7012 043 | |
| | EAR CLIP DOUBLE 43-46/10 | 43-46 | 1 11/16-1 13/16" | 0110 7012 046 | |



Refer to page 193

NORMACONNECT® – Pipe Connections

The perfect method of connecting pipes

When it comes to pipe connections, the industry and OEMs rely on NORMACONNECT® – the reliable solution that can be used with all kinds of different requirements, pipe materials and outer pipe diameters.



Our solution for connecting – FGR

FGR pipe couplings are a compact, economical and reliable means for connecting plain-ended pipes. They are suitable for joining plastic and metal pipes and especially pipes made from stainless steel. They can be used in mechanical engineering and construction, shipbuilding, civil engineering and in hydro technology, water supply and water treatment.

Supply pipes as well as exhaust pipes for solid, liquid or gaseous media can be joined easily and safely in a very short period of time even in narrow spaces. Thanks to the wide range of various types and sizes they are suitable for use both in standard and specialized applications.

Product benefits

FGR pipe couplings are an economical alternative to conventional pipe joining techniques for both plastic and metal pipes. All plain-ended pipes can be joined easily by hand. The ready-to-fit coupling is pushed over the pipe ends and then aligned and rotated to any fitting position. Tightening the two bolts alternately with a torque wrench is all it takes to make a safe fitting.

Range of applications

FGR pipe coupling is a reliable connection for thick- and thin-walled pipes which conforms to the latest DIN Standard 86128. Feed and return lines for liquids, gases and solids (for mechanical engineering and construction, civil engineering, shipbuilding, pipeline construction, power stations, mining, filters, water technology, etc.) are joined quickly, easily and safely using FGR pipe couplings.

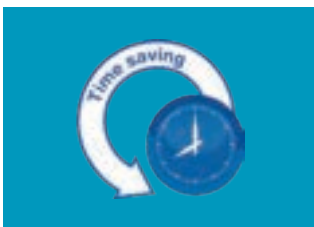

- No welding
- No necessity for prior pipe alignment or treatment of pipe ends
- Up to 80% time saving

- Compensates for pipe gaps up to 65 mm
- Compensates for axial movements up to 7.5 mm
- Compensates for misalignment up to 3 mm

- 70 % less weight

- Compensates for angular deflection up to + or - 2° in total

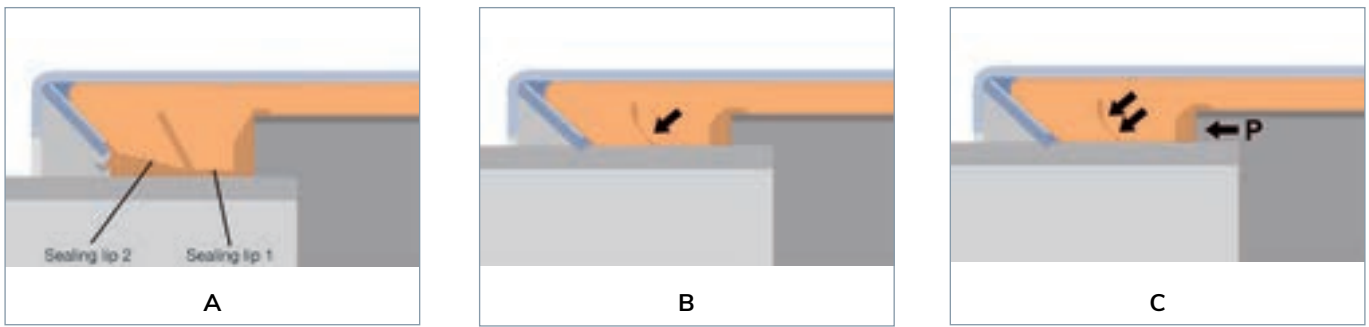

1. Double-lip sealing system

The patented double-lip sealing system of the FGR pipe couplings offers double safety. It provides maximum sealability at both low and high operating pressures (Fig. A).

When the bolts of the coupling are tightened, sealing lip 1 is pressed onto sealing lip 2, thus providing a highly reliable seal even under conditions of low pressure, vacuum or extreme loads acting on the joint (Fig. B).

The special sealing lip design means that when the internal pressure (P) increases, the sealing lips are pressed more firmly onto the pipe surface ensuring an even stronger seal (Fig. C).

2. Strip insert included as standard

All FGR pipe couplings are factory equipped with the strip insert as standard. The strip insert protects the sealing sleeve from increased mechanical and chemical loads. It also prevents the sealing sleeve from moisture expansion and allows larger gaps between the pipe ends to be connected.

Furthermore, it compensates for larger angular deflections and misalignment. With the strip insert the couplings can also be used for both vacuum and high pressure applications without any problems. The strip inserts are made from plastic material or stainless steel.

3. Heavy duty lock bars

For FGR pipe couplings we use lock bars with a larger diameter. Thus the rigidity of the coupling is increased and the engagement of the threaded end of the locking bolts is considerably improved.

4. Anchoring ring with conically stamped teeth

The anchoring ring with conically stamped teeth indents into the pipe surface and provides safe and strong axial restraint. Owing to the special design the coupling is able to withstand even high vibration loads.







5. Protection ring

The protection ring protects the sealing sleeve from UV rays, fire, etc., and increases the flexural strength of the coupling.



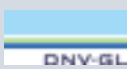

Approvals



NORMA CONNECT®

| Shipbuilding | | FLEX / FLEX E / RFP | GRIP / GRIP E / Grip E-FP / RFP | CombiGrip / CombiGrip E | PlastGrip / PlastGrip E | Rep E |
|----------------|---|---------------------|---------------------------------|-------------------------|-------------------------|-------|
| ABS |  | • | • | • | • | |
| Bureau Veritas |  | • | • | • | • | |
| DNV |  | • | • | • | • | |
| LR |  | • ¹ | • ¹ | • | • | |
| RINA |  | • | • | | | |
| MRS |  | • | • | • | • | |
| PRS |  | • ¹ | • ¹ | | | |



Water supply & treatment

| | | | | | | |
|----------------------------------|---|---|---|---|----------------|---|
| Elastomer guideline KTW/TZW W270 | | • | • | • | • | • |
| DVGW |  | | | | • ² | |
| GOST |  | • | • | • | • | • |
| NSF |  | • | • | • | • | |

GAS

| | | | | | | |
|------------|---|--|---|--|---|--|
| DVGW / gwi |  | | • | | | |
| BAM |  | | • | | • | |

Special approvals

| | | | | | | |
|---------------------------|---|---|----------------|---|---|--|
| DIBT / TÜV south. Germany | | | • | | | |
| BAAINBW |  | | • ³ | | | |
| FDA |  | • | • | • | • | |

¹ No approvals for RFP

² From 40.0 mm up to 160 mm

³ Approval for German Navy / NATO vessels

Pressure rating for axial non restraint pipe couplings type Flex

| Pipes to be joined | Size (mm) | Flex | Flex E | Flex 3 | REP E from 35 mm |
|--------------------|-----------------|--------------|--------------|-----------------|------------------|
| Metal + Metal | 26.9 to 168.3 | 70 to 32 bar | 70 to 32 bar | - | 60 to 32 bar |
| | 180.0 to 1219.2 | 50 to 7 bar | 30 to 4 bar | - | 30 to 4 bar |
| | 326.0 to 2032.0 | - | - | 16.5 to 1.5 bar | - |
| Plastic + Plastic | 26.9 to 168.3 | 16 bar | 16 bar | - | 16 bar |
| | 180.0 to 1219.2 | 16 to 4 bar | 16 to 4 bar | - | 16 to 4 bar |
| Metal + Plastic | 26.9 to 168.3 | 16 bar | 16 bar | - | - |
| | 180.0 to 1219.2 | 16 to 7 bar | 16 to 7 bar | - | - |

Larger diameters available on request

Pressure rating for axial restraint pipe couplings type Grip

| Pipes to be joined | Size (mm) | Grip | Grip E | Combi-Grip E | Combi-Grip | Plast-Grip E | Plast-Grip | Grip E-FP |
|--------------------|----------------------------|--------------|--------------|--------------|-------------|--------------|-------------|--------------|
| Metal + Metal | 26.9 to 168.3 | 70 to 32 bar | 70 to 32 bar | - | - | - | - | 60 to 32 bar |
| | 180.0 to 419.0 | - | 20 to 2 bar | - | - | - | - | 20 to 65 bar |
| | 180.0 to 812.8 | 32 to 1 bar | - | - | - | - | - | - |
| Plastic + Plastic | 40.0 to 168.3 | - | - | - | - | 16 bar | - | - |
| | 200.0 to 406.4 | - | - | - | - | - | 16 to 6 bar | - |
| Metal + Plastic | 38/40 to 160/168.3 | 16 bar | 16 bar | 16 bar | - | - | - | - |
| | 200.0/204.0 to 406.0/406.4 | - | - | - | 16 to 6 bar | - | - | - |

Larger diameters available on request

Sealing sleeves

| Material of seal | EPDM | NBR | FKM |
|-------------------|--|---|--|
| Temperature range | -30 °C up to +125 °C OD 26.9 up to 168.3 mm -20 °C up to +80 °C OD > 180 mm | -20 °C up to +80 °C | -10 °C to +150 °C* |
| Media | Drinking water Alcohols Compressed air Solids | Water Oils Gases (combustible) Fuels Hydrocarbons | Steam Several gases Hot water Ozone Oxygen Several acids** Several alkalis** Hydrocarbons |

* Higher temperatures possible in some cases

** Case by case approval required. Please check with your sales representative

FGR Materials

Components and materials in accordance with AISI/BS. FGR pipe couplings are available in the materials W2, W4 and W5.

| W2 | | | | |
|-------|--|---------------------|---------------------|-----------------------------|
| No. | Component | Flex/Flex E | Grip/Grip E | Plast Grip/ Plast Grip E |
| 1 | Housing with bridge | 304/304 S31 | 304/304 S31 | 304/304 S31 |
| 2 | Sealing sleeve | EPDM/NBR | EPDM/NBR | EPDM/NBR |
| 3 | Strip insert ¹⁾ | 316Ti/320 S31/PA-GR | 316Ti/320 S31/PA-GR | 316Ti/320 S31/PA-GR |
| 4 A | Anchoring ring for metal pipes ²⁾ | – | 301/301 S21 | – |
| 4 A | Anchoring ring for plastic pipes ²⁾ | – | – | PA-GF-NS ³⁾ |
| 4 B | Protection ring | 316Ti/320 S31 | – | – |
| 5 + 6 | Solid locking trunnions | AISI 1213 | AISI 1213 | AISI 1213 |
| 5 + 6 | Hollow locking trunnions | AISI 1518 | AISI 1518 | AISI 1518 |
| 7 | Locking bolts | 10.9 | 10.9 | 10.9 |
| 8 | Washer | A4-80/316 | A4-80/316 | A4-80/316 |

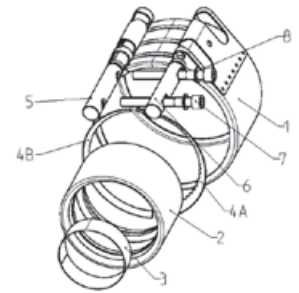

| W4 | | | | |
|-------|--|---------------------|---------------------|-----------------------------|
| No. | Component | Flex/Flex E | Grip/Grip E | Plast Grip/ Plast Grip E |
| 1 | Housing with bridge | 304/304 S31 | 304/304 S31 | 304/304 S31 |
| 2 | Sealing sleeve | EPDM/NBR | EPDM/NBR | EPDM/NBR |
| 3 | Strip insert ¹⁾ | 316Ti/320 S31/PA-GR | 316Ti/320 S31/PA-GR | 316Ti/320 S31/PA-GR |
| 4 A | Anchoring ring for metal pipes ²⁾ | – | 301/301 S21 | – |
| 4 A | Anchoring ring for plastic pipes ²⁾ | – | – | PA-GF-NS ³⁾ |
| 4 B | Protection ring | 316Ti/320 S31 | 316Ti/320 S31 | – |
| 5 + 6 | Solid locking trunnions | 316L | 316L | 316L |
| 5 + 6 | Hollow locking trunnions | 316Ti/320 S31 | 316Ti/320 S31 | 316Ti/320 S31 |
| 7 | Locking bolts | A4-80/316 | A4-80/316 | A4-80 |
| 8 | Washer | A4-80/316 | A4-80/316 | A4-80 |

¹⁾ PA-GF plastic strip inserts are only for pipe couplings used in shipbuilding applications.

²⁾ COMBI GRIP couplings are equipped with two different anchoring rings (1 x for the metal end, 1 x for the plastic end).

³⁾ PA-GF: PA reinforced with fiber glass; NS: new silver.

| W5 | | | | | | |
|-------|--|---------------------|---------------------|-----------------------------|-----------------------------|---------------------|
| No. | Component | Flex/Flex E | Grip/Grip E | Combi Grip/ Combi Grip E | Plast Grip/ Plast Grip E | Rep E |
| 1 | Housing | 316Ti/320 S31 | 316Ti/320 S31 | 316Ti/320 S31 | 316Ti/320 S31 | 316Ti/320 S31 |
| 2 | Sealing sleeve | EPDM/NBR/FKM | EPDM/NBR/FKM | EPDM/NBR | EPDM/NBR | EPDM/NBR |
| 3 | Strip insert ¹⁾ | 316Ti/320 S31/PA-GR | 316Ti/320 S31/PA-GR | 316Ti/320 S31/PA-GR | 316Ti/320 S31/PA-GR | 316Ti/320 S31/PA-GR |
| 4 A | Anchoring ring for metal pipes ²⁾ | – | 301/301 S21 | 301/301 S21 301/301 S21 | – | – |
| 4 A | Anchoring ring for plastic pipes ²⁾ | – | – | PA-GF-NS ³⁾ | PA-GF-NS ³⁾ | – |
| 4 B | Protection ring | 316Ti/320 S31 | – | – | – | – |
| 5 + 6 | Solid locking trunnions | 316L | 316L | 316L | 316L | 316L |
| 5 + 6 | Hollow locking trunnions | 316Ti/320 S31 | 316Ti/320 S31 | 316Ti/320 S31 | 316Ti/320 S31 | 316Ti/320 S31 |
| 7 | Locking bolts | A4-80/316 | A4-80/316 | A4-80/316 | A4-80/316 | A4-80/316 |
| 8 | Washer | A4-80/316 | A4-80/316 | A4-80/316 | A4-80/316 | A4-80/316 |

¹⁾ PA-GF plastic strip inserts are only for pipe couplings used in shipbuilding applications.

²⁾ COMBI GRIP couplings are equipped with two different anchoring rings (1 x for the metal end, 1 x for the plastic end).

³⁾ PA-GF: PA reinforced with fiber glass; NS: nickel and silver.

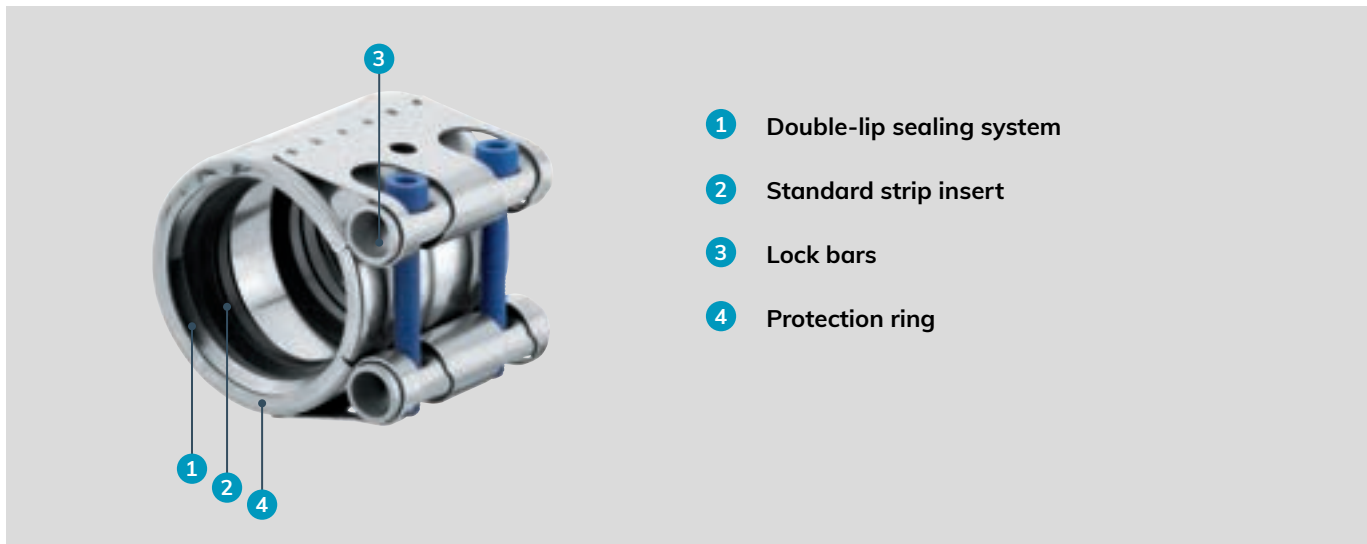

- 1 Double-lip sealing system
- 2 Standard strip insert
- 3 Lock bars
- 4 Protection ring

The protective pipe coupling

NORMACONNECT® FLEX /FLEX E are axial non-restraint couplings. They are used for all kind of metal pipes, as well as pipes made of concrete or plastic. Sealing reliability is ensured even when NORMACONNECT® FLEX /FLEX E pipe couplings are mounted on pipes with or without a gap and also on compensated pipes.



NORMACONNECT®

Advantages at a glance

- ✓ Compensates for thermal elongation of the pipes
- ✓ Joining all kind of pipe materials is possible, e.g., for steel, plastic, cast iron, etc.

Information

- Sizes: 26.9 mm –1219.1 mm
- Working pressure: 70.0 – 4.0 bar
- Material: AISI 304, AISI 316 Ti
- EPDM:
 Sizes from 26.9 mm up to 168.3 mm: -30 °C up to +125 °C
 Sizes > 180.0 mm: -20 °C up to +80 °C
- NBR: from -20 °C up to +80 °C
- FKM: -10 °C to +150 °C
 (Higher temperatures possible in some cases.)



Materials

| W1 | W2 | W3 | W4 | W5 |
|----|----|----|----|----|
| | x | | x | x |

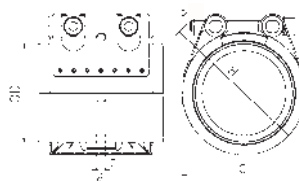
Technical data & Ordering information



Technical data & Ordering information

| NORMACONNECT® FGR FLEX E | | | | | | | | | | | |
|--------------------------|--------------|---|--|---|------------------|-------------------------|-----------|-----------|---------------------------------|--------------------------|---------------------------|
| Ø (O.D.) | Designation | Clamping ranges Oadmin - Odmax (mm) | PN ¹ (MAWP ¹ from diameter 180)  [bar] | WP ²  [bar] | C max (mm) | Dimensions (approx.) | | | Weight (approx.) (kg/pc.) | Hex socket locking bolts | |
| | | | | | | a (mm) | d (mm) | H (mm) | | Thread | Tightening torque (Nm) |
| 26.9 | Flex E 26.9 | 26.4-27.5 | 16 | 70 | 3 | 67 | 50 | 70 | 0.31 | M 8 SW 6 | 5 |
| 28.0 | Flex E 28.0 | 27.5-28.5 | 16 | 70 | 3 | 67 | 50 | 70 | 0.31 | M 8 SW 6 | 5 |
| 30.0 | Flex E 30.0 | 29.5-30.6 | 16 | 70 | 3 | 67 | 50 | 70 | 0.31 | M 8 SW 6 | 5 |
| 33.7 | Flex E 33.7 | 33.0-34.3 | 16 | 60 | 3 | 67 | 55 | 75 | 0.32 | M 8 SW 6 | 5 |
| 35.0 | Flex E 35.0 | 34.5-35.6 | 16 | 60 | 8 | 63 | 55 | 75 | 0.43 | M 8 SW 6 | 5 |
| 38.0 | Flex E 38.0 | 37.5-38.6 | 16 | 60 | 8 | 63 | 60 | 80 | 0.43 | M 8 SW 6 | 5 |
| 42.4 | Flex E 42.4 | 41.7-43.0 | 16 | 50 | 8 | 63 | 65 | 85 | 0.44 | M 8 SW 6 | 5 |
| 44.5 | Flex E 44.5 | 44.0-45.1 | 16 | 50 | 8 | 63 | 65 | 85 | 0.45 | M 8 SW 6 | 5 |
| 48.3 | Flex E 48.3 | 47.6-50.5 | 16 | 50 | 8 | 63 | 70 | 90 | 0.46 | M 8 SW 6 | 5 |
| 54.0 | Flex E 54.0 | 53.3-54.6 | 16 | 50 | 17 | 78 | 75 | 95 | 0.60 | M 8 SW 6 | 10 |
| 57.0 | Flex E 57.0 | 56.3-57.7 | 16 | 50 | 17 | 78 | 80 | 100 | 0.61 | M 8 SW 6 | 10 |
| 60.3 | Flex E 60.3 | 59.5-61.0 | 16 | 40 | 17 | 78 | 85 | 105 | 0.62 | M 8 SW 6 | 10 |
| 63.0 | FLEX E 63.0 | 62.2-63.9 | 16 | 40 | 17 | 78 | 85 | 105 | 0.62 | M 8 SW 6 | 10 |
| 70.0 | Flex E 70.0 | 69.0-71.0 | 16 | 40 | 25 | 98 | 90 | 110 | 1.16 | M 8 SW 6 | 10 |
| 73.0 | Flex E 73.0 | 72.1-73.8 | 16 | 40 | 25 | 98 | 95 | 115 | 1.18 | M 8 SW 6 | 10 |
| 76.1 | Flex E 76.1 | 75.2-77.0 | 16 | 35 | 25 | 98 | 100 | 120 | 1.18 | M 8 SW 6 | 10 |
| 80.0 | Flex E 80.0 | 79.0-80.8 | 16 | 35 | 25 | 98 | 100 | 120 | 1.21 | M 8 SW 6 | 10 |
| 84.0 | Flex E 84.0 | 83.0-85.0 | 16 | 35 | 25 | 98 | 105 | 125 | 1.24 | M 8 SW 6 | 10 |
| 88.9 | Flex E 88.9 | 87.0-89.9 | 16 | 35 | 25 | 98 | 110 | 130 | 1.26 | M 8 SW 6 | 10 |
| 101.6 | Flex E 101.6 | 100.4-102.8 | 16 | 35 | 25 | 98 | 125 | 145 | 1.39 | M 8 SW 6 | 10 |
| 104.0 | Flex E 104.0 | 102.8-106.1 | 16 | 35 | 25 | 98 | 125 | 145 | 1.40 | M 8 SW 6 | 10 |
| 108.0 | Flex E 108.0 | 106.8-109.2 | 16 | 35 | 25 | 98 | 130 | 150 | 1.42 | M 8 SW 6 | 10 |
| 110.0 | Flex E 110.0 | 108.8-111.4 | 16 | 35 | 25 | 98 | 130 | 150 | 1.47 | M 8 SW 6 | 10 |
| 114.3 | Flex E 114.3 | 113.0-115.5 | 16 | 35 | 25 | 98 | 135 | 155 | 1.47 | M 8 SW 6 | 15 |
| 129.0 | Flex E 129.0 | 127.6-131.1 | 16 | 32 | 35 | 113 | 155 | 185 | 2.10 | M 10 SW 8 | 20 |
| 133.0 | Flex E 133.0 | 131.5-134.4 | 16 | 32 | 35 | 113 | 160 | 190 | 2.13 | M 10 SW 8 | 20 |
| 139.7 | Flex E 139.7 | 138.1-141.6 | 16 | 32 | 35 | 113 | 165 | 195 | 2.19 | M 10 SW 8 | 25 |
| 141.3 | Flex E 141.3 | 139.6-142.8 | 16 | 32 | 35 | 113 | 170 | 200 | 2.19 | M 10 SW 8 | 25 |
| 154.0 | Flex E 154.0 | 152.3-156.1 | 16 | 32 | 35 | 113 | 180 | 210 | 2.31 | M 10 SW 8 | 30 |
| 159.0 | Flex E 159.0 | 157.3-160.7 | 16 | 32 | 35 | 113 | 185 | 215 | 2.38 | M 10 SW 8 | 30 |
| 168.3 | Flex E 168.3 | 166.5-170.1 | 16 | 32 | 35 | 113 | 195 | 225 | 2.43 | M 10 SW 8 | 30 |

PN¹ (Nominal Pressure) is the max. admissible working pressure in shipbuilding, based on a safety factor of ≥ 4.
 MAWP¹ (Maximum Allowable Working Pressure) is the max. admissible working pressure in shipbuilding, based on a safety factor of ≥ 4.
 WP² is the max. working pressure in industrial applications, with a safety factor as per NORMA specification.

NORMACONNECT®

Technical data & Ordering information

| NORMACONNECT® FGR FLEX E | | | | | | | | |
|--------------------------|--------------|-------------------|---------------|-------------------|---------------|-------------------|---------------|---------------|
| Ø (O.D.) | Designation | W2 Product No. | | W4 Product No. | | W5 Product No. | | |
| | | EPDM | NBR | EPDM | NBR | EPDM | NBR | FKM |
| 26.9 | Flex E 26.9 | 0582 9100 026 | 0582 8400 026 | 0582 9200 026 | 0582 8500 026 | 0582 9300 026 | 0582 8600 026 | |
| 28.0 | Flex E 28.0 | 0582 9100 028 | 0582 8400 028 | 0582 9200 028 | 0582 8500 028 | 0582 9300 028 | 0582 8600 028 | |
| 30.0 | Flex E 30.0 | 0582 9100 030 | 0582 8400 030 | 0582 9200 030 | 0582 8500 030 | 0582 9300 030 | 0582 8600 030 | |
| 33.7 | Flex E 33.7 | 0582 9100 033 | 0582 8400 033 | 0582 9200 033 | 0582 8500 033 | 0582 9300 033 | 0582 8600 033 | 0582 9900 033 |
| 35.0 | Flex E 35.0 | 0582 9100 035 | 0582 8400 035 | 0582 9200 035 | 0582 8500 035 | 0582 9300 035 | 0582 8600 035 | |
| 38.0 | Flex E 38.0 | 0582 9100 038 | 0582 8400 038 | 0582 9200 038 | 0582 8500 038 | 0582 9300 038 | 0582 8600 038 | 0582 9900 038 |
| 42.4 | Flex E 42.4 | 0582 9100 042 | 0582 8400 042 | 0582 9200 042 | 0582 8500 042 | 0582 9300 042 | 0582 8600 042 | 0582 9900 042 |
| 44.5 | Flex E 44.5 | 0582 9100 044 | 0582 8400 044 | 0582 9200 044 | 0582 8500 044 | 0582 9300 044 | 0582 8600 044 | |
| 48.3 | Flex E 48.3 | 0582 9100 048 | 0582 8400 048 | 0582 9200 048 | 0582 8500 048 | 0582 9300 048 | 0582 8600 048 | 0582 9900 048 |
| 54.0 | Flex E 54.0 | 0582 9100 054 | 0582 8400 054 | 0582 9200 054 | 0582 8500 054 | 0582 9300 054 | 0582 8600 054 | |
| 57.0 | Flex E 57.0 | 0582 9100 057 | 0582 8400 057 | 0582 9200 057 | 0582 8500 057 | 0582 9300 057 | 0582 8600 057 | 0582 9900 057 |
| 60.3 | Flex E 60.3 | 0582 9100 060 | 0582 8400 060 | 0582 9200 060 | 0582 8500 060 | 0582 9300 060 | 0582 8600 060 | 0582 9900 060 |
| 63.0 | FLEX E 63.0 | 0582 9100 063 | 0582 8400 063 | 0582 9200 063 | 0582 8500 063 | 0582 9300 063 | 0582 8600 063 | 0582 9900 063 |
| 70.0 | Flex E 70.0 | 0582 9100 070 | 0582 8400 070 | 0582 9200 070 | 0582 8500 070 | 0582 9300 070 | 0582 8600 070 | |
| 73.0 | Flex E 73.0 | 0582 9100 073 | 0582 8400 073 | 0582 9200 073 | 0582 8500 073 | 0582 9300 073 | 0582 8600 073 | |
| 76.1 | Flex E 76.1 | 0582 9100 076 | 0582 8400 076 | 0582 9200 076 | 0582 8500 076 | 0582 9300 076 | 0582 8600 076 | 0582 9900 076 |
| 80.0 | Flex E 80.0 | 0582 9100 080 | 0582 8400 080 | 0582 9200 080 | 0582 8500 080 | 0582 9300 080 | 0582 8600 080 | |
| 84.0 | Flex E 84.0 | 0582 9100 084 | 0582 8400 084 | 0582 9200 084 | 0582 8500 084 | 0582 9300 084 | 0582 8600 084 | |
| 88.9 | Flex E 88.9 | 0582 9100 088 | 0582 8400 088 | 0582 9200 088 | 0582 8500 088 | 0582 9300 088 | 0582 8600 088 | 0582 9900 088 |
| 101.6 | Flex E 101.6 | 0582 9100 101 | 0582 8400 101 | 0582 9200 101 | 0582 8500 101 | 0582 9300 101 | 0582 8600 101 | |
| 104.0 | Flex E 104.0 | 0582 9100 104 | 0582 8400 104 | 0582 9200 104 | 0582 8500 104 | 0582 9300 104 | 0582 8600 104 | |
| 108.0 | Flex E 108.0 | 0582 9100 108 | 0582 8400 108 | 0582 9200 108 | 0582 8500 108 | 0582 9300 108 | 0582 8600 108 | |
| 110.0 | Flex E 110.0 | 0582 9100 110 | 0582 8400 110 | 0582 9200 110 | 0582 8500 110 | 0582 9300 110 | 0582 8600 110 | |
| 114.3 | Flex E 114.3 | 0582 9100 114 | 0582 8400 114 | 0582 9200 114 | 0582 8500 114 | 0582 9300 114 | 0582 8600 114 | 0582 9900 114 |
| 129.0 | Flex E 129.0 | 0582 9100 129 | 0582 8400 129 | 0582 9200 129 | 0582 8500 129 | 0582 9300 129 | 0582 8600 129 | 0582 9900 129 |
| 133.0 | Flex E 133.0 | 0582 9100 133 | 0582 8400 133 | 0582 9200 133 | 0582 8500 133 | 0582 9300 133 | 0582 8600 133 | |
| 139.7 | Flex E 139.7 | 0582 9100 139 | 0582 8400 139 | 0582 9200 139 | 0582 8500 139 | 0582 9300 139 | 0582 8600 139 | 0582 9900 139 |
| 141.3 | Flex E 141.3 | 0582 9100 141 | 0582 8400 141 | 0582 9200 141 | 0582 8500 141 | 0582 9300 141 | 0582 8600 141 | |
| 154.0 | Flex E 154.0 | 0582 9100 154 | 0582 8400 154 | 0582 9200 154 | 0582 8500 154 | 0582 9300 154 | 0582 8600 154 | |
| 159.0 | Flex E 159.0 | 0582 9100 159 | 0582 8400 159 | 0582 9200 159 | 0582 8500 159 | 0582 9300 159 | 0582 8600 159 | |
| 168.3 | Flex E 168.3 | 0582 9100 168 | 0582 8400 168 | 0582 9200 168 | 0582 8500 168 | 0582 9300 168 | 0582 8600 168 | 0582 9900 168 |

FGR FLEX





NORMACONNECT® FLEX is an axial non-restraint coupling. It is used for connecting metal pipes, stainless pipes, as well as concrete and plastic pipes. This is a full trunnions version.

Material

W2, W4, W5

NORMACONNECT®

| NORMACONNECT® FGR FLEX | | | | | | | | | | | |
|------------------------|-------------|--------------------|---|---|-------|----------------------|--------|--------|------------------|--------------------------|------------------------|
| Ø (O.D.) | Designation | Clamping ranges | PN ¹ (MAWP ¹ from Ø 180) | WP ² | C max | Dimensions (approx.) | | | Weight (approx.) | Hex socket locking bolts | |
| | | Odmin - Odmax (mm) |  [bar] |  [bar] | (mm) | a (mm) | d (mm) | H (mm) | (kg/pc.) | Thread | Tightening torque (Nm) |
| 180.0 | Flex 180.0 | 178.0 - 182.0 | 16.0 | 50.0 | 35 | 141 | 210 | 240 | 5.4 | M 12 SW 10 | 35 |
| 193.7 | Flex 193.7 | 192.0 - 196.0 | 16.0 | 46.0 | 35 | 141 | 225 | 255 | 5.6 | M 12 SW 10 | 35 |
| 206.0 | Flex 206.0 | 202.0 - 208.0 | 16.0 | 43.0 | 35 | 141 | 240 | 270 | 5.8 | M 12 SW 10 | 35 |
| 219.0 | Flex 219.0 | 216.0 - 221.0 | 16.0 | 40.5 | 35 | 141 | 250 | 280 | 6.0 | M 12 SW 10 | 35 |
| 225.0 | Flex 225.0 | 222.0 - 227.0 | 16.0 | 40.0 | 35 | 141 | 255 | 285 | 6.1 | M 12 SW 10 | 35 |
| 229.9 | Flex 229.9 | 228.0 - 232.0 | 16.0 | 39.0 | 35 | 141 | 260 | 290 | 6.2 | M 12 SW 10 | 35 |
| 244.5 | Flex 244.5 | 242.0 - 247.0 | 16.0 | 37.0 | 35 | 141 | 275 | 305 | 6.4 | M 12 SW 10 | 35 |
| 254.0 | Flex 254.0 | 250.0 - 256.0 | 16.0 | 35.5 | 35 | 141 | 285 | 315 | 6.5 | M 12 SW 10 | 35 |
| 267.0 | Flex 267.0 | 264.0 - 269.0 | 16.0 | 33.5 | 35 | 141 | 300 | 330 | 6.7 | M 12 SW 10 | 35 |
| 273.0 | Flex 273.0 | 270.0 - 275.0 | 16.0 | 33.0 | 35 | 141 | 305 | 335 | 6.8 | M 12 SW 10 | 35 |
| 306.0 | Flex 306.0 | 302.0 - 308.0 | 15.0 | 29.0 | 35 | 141 | 340 | 370 | 7.4 | M 12 SW 10 | 35 |
| 323.9 | Flex 323.9 | 320.0 - 327.0 | 15.0 | 28.0 | 35 | 141 | 355 | 385 | 7.6 | M 12 SW 10 | 35 |
| 326.0 | Flex 326.0 | 322.0 - 329.0 | 13.0 | 27.5 | 35 | 141 | 360 | 390 | 7.7 | M 12 SW 10 | 35 |
| 355.6 | Flex 355.6 | 352.0 - 359.0 | 13.0 | 25.0 | 35 | 141 | 390 | 420 | 8.1 | M 12 SW 10 | 35 |
| 406.4 | Flex 406.4 | 402.0 - 410.0 | 10.0 | 22.0 | 35 | 141 | 440 | 470 | 8.9 | M 12 SW 10 | 35 |
| 429.0 | Flex 429.0 | 426.0 - 431.0 | 7.5 | 21.0 | 35 | 141 | 460 | 490 | 9.3 | M 12 SW 10 | 40 |
| 442.0 | Flex 442.0 | 439.0 - 444.0 | 7.5 | 20.0 | 35 | 141 | 475 | 505 | 9.5 | M 12 SW 10 | 40 |
| 457.2 | Flex 457.2 | 454.0 - 459.0 | 7.5 | 19.5 | 35 | 141 | 490 | 520 | 9.7 | M 12 SW 10 | 40 |
| 508.0 | Flex 508.0 | 505.0 - 510.0 | 7.5 | 17.0 | 35 | 141 | 540 | 570 | 10.5 | M 12 SW 10 | 40 |
| 531.0 | Flex 531.0 | 528.0 - 534.0 | 7.5 | 16.0 | 35 | 141 | 565 | 595 | 10.9 | M 12 SW 10 | 50 |
| 558.8 | Flex 558.8 | 556.0 - 562.0 | 7.5 | 15.5 | 35 | 141 | 590 | 620 | 11.3 | M 12 SW 10 | 50 |
| 609.6 | Flex 609.6 | 606.0 - 613.0 | 6.0 | 14.0 | 35 | 141 | 640 | 670 | 12.1 | M 12 SW 10 | 50 |
| 634.0 | Flex 634.0 | 631.0 - 637.0 | 5.0 | 13.5 | 35 | 141 | 665 | 695 | 12.5 | M 12 SW 10 | 50 |
| 711.2 | Flex 711.2 | 707.0 - 715.0 | 5.0 | 12.0 | 35 | 141 | 745 | 775 | 13.7 | M 12 SW 10 | 50 |
| 762.0 | Flex 762.0 | 758.0 - 766.0 | 4.5 | 11.0 | 35 | 141 | 795 | 885 | 14.5 | M 12 SW 10 | 50 |
| 812.8 | Flex 812.8 | 808.0 - 817.0 | 4.5 | 10.5 | 35 | 141 | 845 | 935 | 17.2 | M 12 SW 10 | 50 |
| 914.4 | Flex 914.4 | 909.0 - 919.0 | 3.3 | 9.5 | 35 | 141 | 945 | 1035 | 18.8 | M 12 SW 10 | 60 |
| 1016.0 | Flex 1016.0 | 1013.0 - 1019.0 | 3.3 | 8.0 | 35 | 141 | 1050 | 1140 | 20.4 | M 12 SW 10 | 60 |
| 1117.5 | Flex 1117.5 | 1114.0 - 1120.0 | 3.3 | 7.5 | 35 | 141 | 1150 | 1240 | 22.0 | M 12 SW 10 | 60 |
| 1219.2 | Flex 1219.2 | 1216.0 - 1222.0 | 3.3 | 7.0 | 35 | 141 | 1250 | 1340 | 23.6 | M 12 SW 10 | 60 |

PN¹ (Nominal Pressure) is the max. admissible working pressure in shipbuilding, based on a safety factor of ≥ 4.
 MAWP¹ (Maximum Allowable Working Pressure) is the max. admissible working pressure in shipbuilding, based on a safety factor of ≥ 4.
 WP² is the max. working pressure in industrial applications, with a safety factor as per NORMA specification.

Technical data & Ordering information

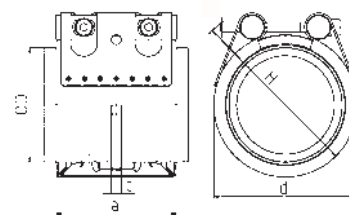

| NORMACONNECT® FGR FLEX | | | | | | | |
|------------------------|-------------|-------------------|---------------|-------------------|---------------|-------------------|---------------|
| Ø (O.D.) | Designation | W2 Product No. | | W4 Product No. | | W5 Product No. | |
| | | EPDM | NBR | EPDM | NBR | EPDM | NBR |
| 180.0 | Flex 180.0 | 0575 8140 180 | 0575 8440 180 | 0575 8240 180 | 0575 8540 180 | 0575 8340 180 | 0575 8640 180 |
| 193.7 | Flex 193.7 | 0575 8140 193 | 0575 8440 193 | 0575 8240 193 | 0575 8540 193 | 0575 8340 193 | 0575 8640 193 |
| 206.0 | Flex 206.0 | 0575 8140 206 | 0575 8440 206 | 0575 8240 206 | 0575 8540 206 | 0575 8340 206 | 0575 8640 206 |
| 219.0 | Flex 219.0 | 0575 8140 219 | 0575 8440 219 | 0575 8240 219 | 0575 8540 219 | 0575 8340 219 | 0575 8640 219 |
| 225.0 | Flex 225.0 | 0575 8140 225 | 0575 8440 225 | 0575 8240 225 | 0575 8540 225 | 0575 8340 225 | 0575 8640 225 |
| 229.9 | Flex 229.9 | 0575 8140 229 | 0575 8440 229 | 0575 8240 229 | 0575 8540 229 | 0575 8340 229 | 0575 8640 229 |
| 244.5 | Flex 244.5 | 0575 8140 244 | 0575 8440 244 | 0575 8240 244 | 0575 8540 244 | 0575 8340 244 | 0575 8640 244 |
| 254.0 | Flex 254.0 | 0575 8140 254 | 0575 8440 254 | 0575 8240 254 | 0575 8540 254 | 0575 8340 254 | 0575 8640 254 |
| 267.0 | Flex 267.0 | 0575 8140 267 | 0575 8440 267 | 0575 8240 267 | 0575 8540 267 | 0575 8340 267 | 0575 8640 267 |
| 273.0 | Flex 273.0 | 0575 8140 273 | 0575 8440 273 | 0575 8240 273 | 0575 8540 273 | 0575 8340 273 | 0575 8640 273 |
| 306.0 | Flex 306.0 | 0575 8140 306 | 0575 8440 306 | 0575 8240 306 | 0575 8540 306 | 0575 8340 306 | 0575 8640 306 |
| 323.9 | Flex 323.9 | 0575 8140 323 | 0575 8440 323 | 0575 8240 323 | 0575 8540 323 | 0575 8340 323 | 0575 8640 323 |
| 326.0 | Flex 326.0 | 0575 8140 326 | 0575 8440 326 | 0575 8240 326 | 0575 8540 326 | 0575 8340 326 | 0575 8640 326 |
| 355.6 | Flex 355.6 | 0575 8140 355 | 0575 8440 355 | 0575 8240 355 | 0575 8540 355 | 0575 8340 355 | 0575 8640 355 |
| 406.4 | Flex 406.4 | 0575 8140 406 | 0575 8440 406 | 0575 8240 406 | 0575 8540 406 | 0575 8340 406 | 0575 8640 406 |
| 429.0 | Flex 429.0 | 0575 8140 429 | 0575 8440 429 | 0575 8240 429 | 0575 8540 429 | 0575 8340 429 | 0575 8640 429 |
| 442.0 | Flex 442.0 | 0575 8140 442 | 0575 8440 442 | 0575 8240 442 | 0575 8540 442 | 0575 8340 442 | 0575 8640 442 |
| 457.2 | Flex 457.2 | 0575 8140 457 | 0575 8440 457 | 0575 8240 457 | 0575 8540 457 | 0575 8340 457 | 0575 8640 457 |
| 508.0 | Flex 508.0 | 0575 8140 508 | 0575 8440 508 | 0575 8240 508 | 0575 8540 508 | 0575 8340 508 | 0575 8640 508 |
| 531.0 | Flex 531.0 | 0575 8140 531 | 0575 8440 531 | 0575 8240 531 | 0575 8540 531 | 0575 8340 531 | 0575 8640 531 |
| 558.8 | Flex 558.8 | 0575 8140 558 | 0575 8440 558 | 0575 8240 558 | 0575 8540 558 | 0575 8340 558 | 0575 8640 558 |
| 609.6 | Flex 609.6 | 0575 8140 609 | 0575 8440 609 | 0575 8240 609 | 0575 8540 609 | 0575 8340 609 | 0575 8640 609 |
| 634.0 | Flex 634.0 | 0575 8140 634 | 0575 8440 634 | 0575 8240 634 | 0575 8540 634 | 0575 8340 634 | 0575 8640 634 |
| 711.2 | Flex 711.2 | 0575 8140 711 | 0575 8440 711 | 0575 8240 711 | 0575 8540 711 | 0575 8340 711 | 0575 8640 711 |
| 762.0 | Flex 762.0 | 0575 8140 762 | 0575 8440 762 | 0575 8240 762 | 0575 8540 762 | 0575 8340 762 | 0575 8640 762 |
| 812.8 | Flex 812.8 | 0575 8140 812 | 0575 8440 812 | 0575 8240 812 | 0575 8540 812 | 0575 8340 812 | 0575 8640 812 |
| 914.4 | Flex 914.4 | 0575 8140 914 | 0575 8440 914 | 0575 8240 914 | 0575 8540 914 | 0575 8340 914 | 0575 8640 914 |
| 1016.0 | Flex 1016.0 | 0575 8141 016 | 0575 8441 016 | 0575 8241 016 | 0575 8541 016 | 0575 8341 016 | 0575 8641 016 |
| 1117.5 | Flex 1117.5 | 0575 8141 117 | 0575 8441 117 | 0575 8241 117 | 0575 8541 117 | 0575 8341 117 | 0575 8641 117 |
| 1219.2 | Flex 1219.2 | 0575 8141 219 | 0575 8441 219 | 0575 8241 219 | 0575 8541 219 | 0575 8341 219 | 0575 8641 219 |

NORMACONNECT®

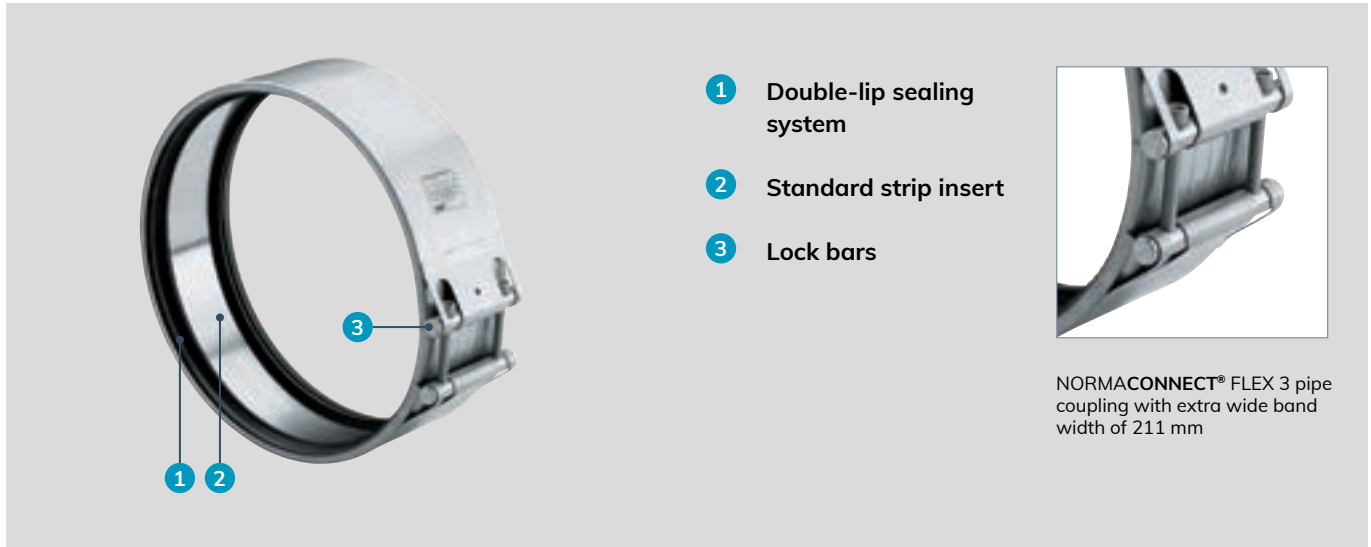

- 1 Double-lip sealing system
- 2 Standard strip insert
- 3 Lock bars

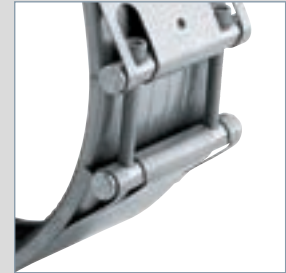

NORMACONNECT® FLEX 3 pipe coupling with extra wide band width of 211 mm

The pipe coupling with extra wide band

NORMACONNECT® FLEX 3 featuring an extra wide band is an axial non-restraint coupling used to connect metal and/or plastic pipes quickly and safely.



Advantages at a glance

- ✓ Easy and quick to assemble
- ✓ Pipe end distance up to 65 mm possible
- ✓ Compensation of misalignment, angular deflection up to 4° possible

Information

- Sizes: from 812.8 mm to 2032.0 mm
- Working pressure: 6.5 bar – 1.5 bar
- Solid trunnions
- 2 closure units
- Material: AISI 316 Ti
- EPDM: from -20 °C up to +80 °C
- NBR: from -20 °C up to +80 °C

Materials

| | | | | |
|----|----|----|----|----|
| W1 | W2 | W3 | W4 | W5 |
| | | | | x |

Technical data & Ordering information

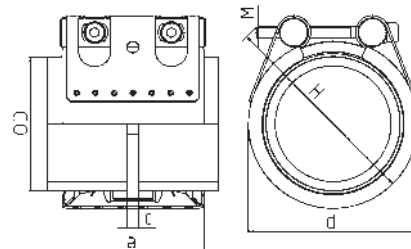

Technical data & Ordering information

| NORMACONNECT® FGR FLEX 3 | | | | | | | | | | | | |
|--------------------------|---------------|--------------------|--|----------|-------------------------|-----------|-----------|---------------------|--------------------------|---------------------------|-------------------|---------------|
| Ø (O.D.) | Designation | Clamping ranges | WP ¹ | C max | Dimensions (approx.) | | | Weight (approx.) | Hex socket locking bolts | | W5 Product No. | |
| | | |  [bar] | (mm) | a (mm) | d (mm) | H (mm) | (kg/pc.) | Thread | Tightening torque (Nm) | EPDM | NBR |
| 812.8 | Flex 3 812.8 | 808.0 - 817.0 | 6.5 | 65 | 211 | 850 | 890 | 21.4 | M 16 SW 14 | 45 | 0571 8330 812 | 0571 8630 812 |
| 914.4 | Flex 3 914.4 | 909.0 - 919.0 | 6.0 | 65 | 211 | 950 | 990 | 23.4 | M 16 SW 14 | 45 | 0571 8330 914 | 0571 8630 914 |
| 1016.0 | Flex 3 1016.0 | 1013.0 - 1019.0 | 5.0 | 65 | 211 | 1055 | 1095 | 25.4 | M 16 SW 14 | 50 | 0571 8331 016 | 0571 8631 016 |
| 1117.5 | Flex 3 1117.5 | 1114.0 - 1120.0 | 4.5 | 65 | 211 | 1155 | 1195 | 27.4 | M 16 SW 14 | 50 | 0571 8331 117 | 0571 8631 117 |
| 1219.2 | Flex 3 1219.2 | 1216.0 - 1222.0 | 4.0 | 65 | 211 | 1255 | 1295 | 29.4 | M 16 SW 14 | 55 | 0571 8331 219 | 0571 8631 219 |
| 1320.8 | Flex 3 1320.8 | 1314.0 - 1328.0 | 3.0 | 65 | 211 | 1360 | 1400 | 31.4 | M 16 SW 14 | 55 | 0571 8331 320 | 0571 8631 320 |
| 1422.4 | Flex 3 1422.4 | 1415.0 - 1430.0 | 3.0 | 65 | 211 | 1460 | 1500 | 33.4 | M 16 SW 14 | 60 | 0571 8331 422 | 0571 8631 422 |
| 1524.0 | Flex 3 1524.0 | 1516.0 - 1532.0 | 2.5 | 65 | 211 | 1560 | 1600 | 35.4 | M 16 SW 14 | 60 | 0571 8331 524 | 0571 8631 524 |
| 1625.6 | Flex 3 1625.6 | 1617.0 - 1634.0 | 2.5 | 65 | 211 | 1665 | 1705 | 37.4 | M 16 SW 14 | 70 | 0571 8331 625 | 0571 8631 625 |
| 1727.2 | Flex 3 1727.2 | 1718.0 - 1736.0 | 2.0 | 65 | 211 | 1765 | 1805 | 39.4 | M 16 SW 14 | 70 | 0571 8331 727 | 0571 8631 727 |
| 1828.8 | Flex 3 1828.8 | 1819.0 - 1838.0 | 2.0 | 65 | 211 | 1865 | 1905 | 41.4 | M 16 SW 14 | 80 | 0571 8331 828 | 0571 8631 828 |
| 1930.4 | Flex 3 1930.4 | 1320.0 - 1940.0 | 2.0 | 65 | 211 | 1970 | 2010 | 43.4 | M 16 SW 14 | 80 | 0571 8331 930 | 0571 8631 930 |
| 2032.0 | Flex 3 2032.0 | 2021.0 - 2042.0 | 1.5 | 65 | 211 | 2070 | 2110 | 45.4 | M 16 SW 14 | 80 | 0571 8332 032 | 0571 8632 032 |

WP¹ is the max. working pressure in industrial applications, with a safety factor as per NORMA specification.



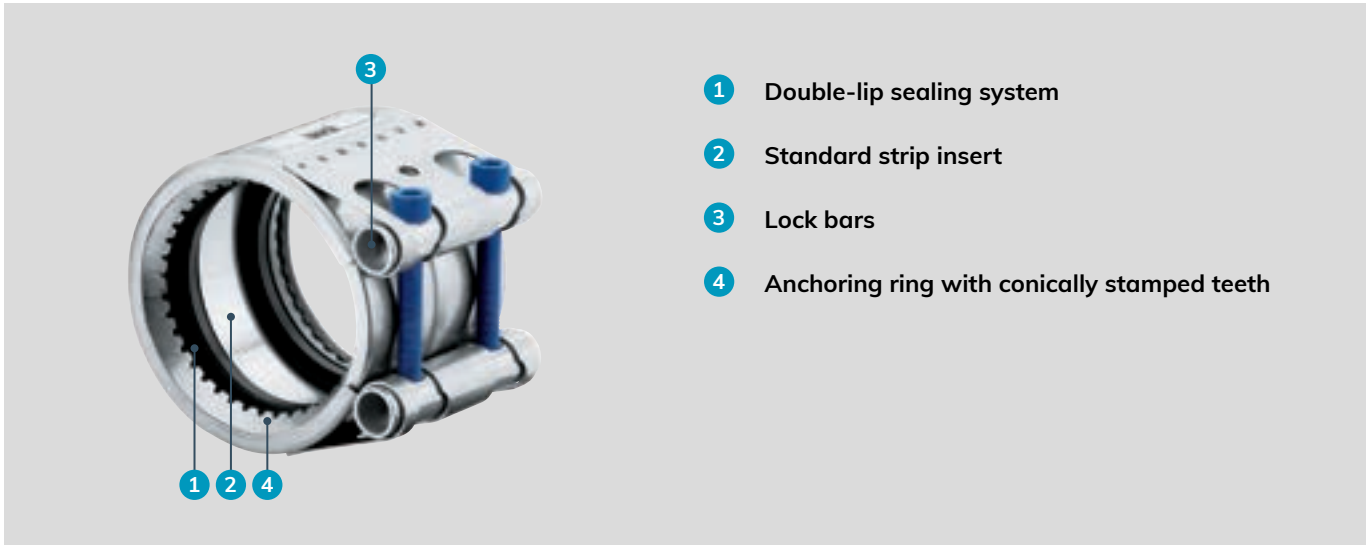

The strong pipe coupling

NORMACONNECT® GRIP/GRIP E axial restraint pipe couplings are used to connect metal pipes. The anchoring ring with conically stamped teeth indents into the pipe surface (steel, stainless steel or cast iron) and provides safe and strong axial restraint. Owing to the special design, the coupling can withstand even high vibration loads.

Advantages at a glance

- ✓ Progressive locking effect ensures a trouble- and maintenance-free connection
- ✓ Reusable
- ✓ Shock resistant
- ✓ Space saving connector
- ✓ Withstand high vibration loads

Information

- Sizes: 26.9 mm – 812.8 mm
- Working pressure: 70.0 bar – 1 bar
- Material: AISI 304, AISI 316 Ti
- EPDM:
 - Sizes from 26.9 mm up to 168.3 mm: -30 °C up to +125 °C
 - Sizes > 180.0 mm: from -20 °C up to +80 °C
- NBR: from -20 °C up to +80 °C
- FKM: -10 °C to +150 °C
(Higher temperatures possible in some cases.)



Materials

| W1 | W2 | W3 | W4 | W5 |
|----|----|----|----|----|
| | x | | x | x |

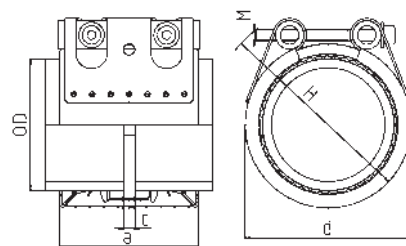
Technical data & Ordering information



Technical data & Ordering information

| NORMACONNECT® FGR GRIP E | | | | | | | | | | | |
|--------------------------|--------------|-----------------------|--|--|----------|-------------------------|-----------|-----------|---------------------|--------------------------|---------------------------|
| Ø (O.D.) | Designation | Clamping ranges | PN ¹ | WP ² | C max | Dimensions (approx.) | | | Weight (approx.) | Hex socket locking bolts | |
| | | Odmin - Odmax (mm) |  [bar] |  [bar] | (mm) | a (mm) | d (mm) | H (mm) | (kg/pc.) | Thread | Tightening torque (Nm) |
| 26.9 | Grip E 26.9 | 26.4 - 27.5 | 16 | 70 | 3 | 67 | 50 | 70 | 0.32 | M 8 SW 6 | 10 |
| 28.0 | Grip E 28.0 | 27.5 - 28.5 | 16 | 70 | 3 | 67 | 50 | 70 | 0.32 | M 8 SW 6 | 10 |
| 30.0 | Grip E 30.0 | 29.5 - 30.6 | 16 | 70 | 3 | 67 | 50 | 70 | 0.32 | M 8 SW 6 | 10 |
| 33.7 | Grip E 33.7 | 33.0 - 34.3 | 16 | 60 | 3 | 67 | 55 | 75 | 0.33 | M 8 SW 6 | 10 |
| 35.0 | Grip E 35.0 | 34.5 - 35.6 | 16 | 60 | 8 | 63 | 55 | 75 | 0.45 | M 8 SW 6 | 15 |
| 38.0 | Grip E 38.0 | 37.5 - 38.6 | 16 | 60 | 8 | 63 | 60 | 80 | 0.45 | M 8 SW 6 | 15 |
| 42.4 | Grip E 42.4 | 41.7 - 43.0 | 16 | 50 | 8 | 63 | 65 | 85 | 0.46 | M 8 SW 6 | 15 |
| 44.5 | Grip E 44.5 | 44.0 - 45.1 | 16 | 50 | 8 | 63 | 65 | 85 | 0.47 | M 8 SW 6 | 15 |
| 48.3 | Grip E 48.3 | 47.6 - 50.5 | 16 | 50 | 8 | 63 | 70 | 90 | 0.48 | M 8 SW 6 | 15 |
| 54.0 | Grip E 54.0 | 53.3 - 54.6 | 16 | 50 | 17 | 78 | 75 | 95 | 0.62 | M 8 SW 6 | 15 |
| 57.0 | Grip E 57.0 | 56.3 - 57.7 | 16 | 50 | 17 | 78 | 80 | 100 | 0.63 | M 8 SW 6 | 20 |
| 60.3 | Grip E 60.3 | 59.5 - 61.0 | 16 | 40 | 17 | 78 | 85 | 105 | 0.64 | M 8 SW 6 | 20 |
| 70.0 | Grip E 70.0 | 69.0 - 71.0 | 16 | 40 | 25 | 98 | 90 | 110 | 1.21 | M 10 SW 8 | 30 |
| 73.0 | Grip E 73.0 | 72.1 - 73.8 | 16 | 40 | 25 | 98 | 95 | 115 | 1.23 | M 10 SW 8 | 30 |
| 76.1 | Grip E 76.1 | 75.2 - 77.0 | 16 | 35 | 25 | 98 | 100 | 120 | 1.23 | M 10 SW 8 | 30 |
| 80.0 | Grip E 80.0 | 79.0 - 80.8 | 16 | 35 | 25 | 98 | 100 | 120 | 1.27 | M 10 SW 8 | 30 |
| 84.0 | Grip E 84.0 | 83.0 - 85.0 | 16 | 35 | 25 | 98 | 105 | 125 | 1.29 | M 10 SW 8 | 30 |
| 88.9 | Grip E 88.9 | 87.0 - 89.9 | 16 | 35 | 25 | 98 | 110 | 130 | 1.31 | M 10 SW 8 | 30 |
| 101.6 | Grip E 101.6 | 100.4 - 102.8 | 16 | 35 | 25 | 98 | 125 | 145 | 1.45 | M 10 SW 8 | 30 |
| 104.0 | Grip E 104.0 | 102.8 - 106.1 | 16 | 35 | 25 | 98 | 125 | 145 | 1.46 | M 10 SW 8 | 30 |
| 108.0 | Grip E 108.0 | 106.8 - 109.2 | 16 | 35 | 25 | 98 | 130 | 150 | 1.49 | M 10 SW 8 | 30 |
| 110.0 | Grip E 110.0 | 108.8 - 111.4 | 16 | 35 | 25 | 98 | 130 | 150 | 1.54 | M 10 SW 8 | 30 |
| 114.3 | Grip E 114.3 | 113.0 - 115.5 | 16 | 35 | 25 | 98 | 135 | 155 | 1.54 | M 10 SW 8 | 50 |
| 129.0 | Grip E 129.0 | 127.6 - 131.1 | 16 | 32 | 35 | 115 | 155 | 185 | 2.83 | M 12 SW 10 | 50 |
| 133.0 | Grip E 133.0 | 131.5 - 134.4 | 16 | 32 | 35 | 115 | 160 | 190 | 2.93 | M 12 SW 10 | 50 |
| 139.7 | Grip E 139.7 | 138.1 - 141.6 | 16 | 32 | 35 | 115 | 165 | 195 | 3.04 | M 12 SW 10 | 50 |
| 141.3 | Grip E 141.3 | 139.6 - 142.8 | 16 | 32 | 35 | 115 | 170 | 200 | 3.04 | M 12 SW 10 | 50 |
| 154.0 | Grip E 154.0 | 152.3 - 156.1 | 16 | 32 | 35 | 115 | 180 | 210 | 3.17 | M 12 SW 10 | 60 |
| 159.0 | Grip E 159.0 | 157.3 - 160.7 | 16 | 32 | 35 | 115 | 185 | 215 | 3.28 | M 12 SW 10 | 60 |
| 168.3 | Grip E 168.3 | 166.5 - 170.1 | 16 | 32 | 35 | 115 | 195 | 225 | 3.35 | M 12 SW 10 | 60 |

PN¹ (Nominal Pressure) is the max. admissible working pressure in shipbuilding, based on a safety factor of ≥ 4 .
 WP² is the max. working pressure in industrial applications, with a safety factor as per NORMA specification.

Technical data & Ordering information

| NORMACONNECT® FGR GRIP E | | | | | | | | |
|--------------------------|--------------|-------------------|---------------|-------------------|---------------|-------------------|---------------|---------------|
| Ø (O.D.) | Designation | W2 Product No. | | W4 Product No. | | W5 Product No. | | |
| | | EPDM | NBR | EPDM | NBR | EPDM | NBR | FKM |
| 26.9 | Grip E 26.9 | 0579 9100 026 | 0579 8400 026 | 0579 9200 026 | 0579 8500 026 | 0579 9300 026 | 0579 8600 026 | |
| 28.0 | Grip E 28.0 | 0579 9100 028 | 0579 8400 028 | 0579 9200 028 | 0579 8500 028 | 0579 9300 028 | 0579 8600 028 | |
| 30.0 | Grip E 30.0 | 0579 9100 030 | 0579 8400 030 | 0579 9200 030 | 0579 8500 030 | 0579 9300 030 | 0579 8600 030 | |
| 33.7 | Grip E 33.7 | 0579 9100 033 | 0579 8400 033 | 0579 9200 033 | 0579 8500 033 | 0579 9300 033 | 0579 8600 033 | 0579 9900 033 |
| 35.0 | Grip E 35.0 | 0579 9100 035 | 0579 8400 035 | 0579 9200 035 | 0579 8500 035 | 0579 9300 035 | 0579 8600 035 | |
| 38.0 | Grip E 38.0 | 0579 9100 038 | 0579 8400 038 | 0579 9200 038 | 0579 8500 038 | 0579 9300 038 | 0579 8600 038 | 0579 9900 038 |
| 42.4 | Grip E 42.4 | 0579 9100 042 | 0579 8400 042 | 0579 9200 042 | 0579 8500 042 | 0579 9300 042 | 0579 8600 042 | 0579 9900 042 |
| 44.5 | Grip E 44.5 | 0579 9100 044 | 0579 8400 044 | 0579 9200 044 | 0579 8500 044 | 0579 9300 044 | 0579 8600 044 | |
| 48.3 | Grip E 48.3 | 0579 9100 048 | 0579 8400 048 | 0579 9200 048 | 0579 8500 048 | 0579 9300 048 | 0579 8600 048 | 0579 9900 048 |
| 54.0 | Grip E 54.0 | 0579 9100 054 | 0579 8400 054 | 0579 9200 054 | 0579 8500 054 | 0579 9300 054 | 0579 8600 054 | |
| 57.0 | Grip E 57.0 | 0579 9100 057 | 0579 8400 057 | 0579 9200 057 | 0579 8500 057 | 0579 9300 057 | 0579 8600 057 | 0579 9900 057 |
| 60.3 | Grip E 60.3 | 0579 9100 060 | 0579 8400 060 | 0579 9200 060 | 0579 8500 060 | 0579 9300 060 | 0579 8600 060 | 0579 9900 060 |
| 63.0 | Grip E 63.0 | 0579 9100 063 | 0579 8400 063 | 0579 9200 063 | 0579 8500 063 | 0579 9300 063 | 0579 8600 063 | 0579 9900 063 |
| 70.0 | Grip E 70.0 | 0579 9100 070 | 0579 8400 070 | 0579 9200 070 | 0579 8500 070 | 0579 9300 070 | 0579 8600 070 | |
| 73.0 | Grip E 73.0 | 0579 9100 073 | 0579 8400 073 | 0579 9200 073 | 0579 8500 073 | 0579 9300 073 | 0579 8600 073 | |
| 76.1 | Grip E 76.1 | 0579 9100 076 | 0579 8400 076 | 0579 9200 076 | 0579 8500 076 | 0579 9300 076 | 0579 8600 076 | 0579 9900 076 |
| 80.0 | Grip E 80.0 | 0579 9100 080 | 0579 8400 080 | 0579 9200 080 | 0579 8500 080 | 0579 9300 080 | 0579 8600 080 | |
| 84.0 | Grip E 84.0 | 0579 9100 084 | 0579 8400 084 | 0579 9200 084 | 0579 8500 084 | 0579 9300 084 | 0579 8600 084 | |
| 88.9 | Grip E 88.9 | 0579 9100 088 | 0579 8400 088 | 0579 9200 088 | 0579 8500 088 | 0579 9300 088 | 0579 8600 088 | 0579 9900 088 |
| 101.6 | Grip E 101.6 | 0579 9100 101 | 0579 8400 101 | 0579 9200 101 | 0579 8500 101 | 0579 9300 101 | 0579 8600 101 | |
| 104.0 | Grip E 104.0 | 0579 9100 104 | 0579 8400 104 | 0579 9200 104 | 0579 8500 104 | 0579 9300 104 | 0579 8600 104 | |
| 108.0 | Grip E 108.0 | 0579 9100 108 | 0579 8400 108 | 0579 9200 108 | 0579 8500 108 | 0579 9300 108 | 0579 8600 108 | |
| 110.0 | Grip E 110.0 | 0579 9100 110 | 0579 8400 110 | 0579 9200 110 | 0579 8500 110 | 0579 9300 110 | 0579 8600 110 | |
| 114.3 | Grip E 114.3 | 0579 9100 114 | 0579 8400 114 | 0579 9200 114 | 0579 8500 114 | 0579 9300 114 | 0579 8600 114 | 0579 9900 114 |
| 129.0 | Grip E 129.0 | 0579 9100 129 | 0579 8400 129 | 0579 9200 129 | 0579 8500 129 | 0579 9300 129 | 0579 8600 129 | 0579 9900 129 |
| 133.0 | Grip E 133.0 | 0579 9100 133 | 0579 8400 133 | 0579 9200 133 | 0579 8500 133 | 0579 9300 133 | 0579 8600 133 | |
| 139.7 | Grip E 139.7 | 0579 9100 139 | 0579 8400 139 | 0579 9200 139 | 0579 8500 139 | 0579 9300 139 | 0579 8600 139 | 0579 9900 139 |
| 141.3 | Grip E 141.3 | 0579 9100 141 | 0579 8400 141 | 0579 9200 141 | 0579 8500 141 | 0579 9300 141 | 0579 8600 141 | |
| 154.0 | Grip E 154.0 | 0579 9100 154 | 0579 8400 154 | 0579 9200 154 | 0579 8500 154 | 0579 9300 154 | 0579 8600 154 | |
| 159.0 | Grip E 159.0 | 0579 9100 159 | 0579 8400 159 | 0579 9200 159 | 0579 8500 159 | 0579 9300 159 | 0579 8600 159 | |
| 168.3 | Grip E 168.3 | 0579 9100 168 | 0579 8400 168 | 0579 9200 168 | 0579 8500 168 | 0579 9300 168 | 0579 8600 168 | 0579 9900 168 |

NORMACONNECT®

FGR GRIP



NORMACONNECT® GRIP axial restraint pipe couplings are used to connect metal pipes.

Material

W2, W4, W5

| NORMACONNECT® FGR GRIP | | | | | | | | | | | |
|------------------------|-------------|--|---|---|------------------|-------------------------|-----------|-----------|---------------------------------|--------------------------|---------------------------|
| Ø (O.D.) | Designation | Clamping ranges Odmin - Odmax (mm) | PN ¹  [bar] | WP ²  [bar] | C max (mm) | Dimensions (approx.) | | | Weight (approx.) (kg/pc.) | Hex socket locking bolts | |
| | | | | | | a (mm) | d (mm) | H (mm) | | Thread | Tightening torque (Nm) |
| 193.7 | Grip 193.7 | 192.0 - 196.0 | 16 | 32 | 35 | 142 | 225 | 255 | 6.8 | M 16 SW 14 | 150 |
| 206.0 | Grip 206.0 | 202.0 - 208.0 | 16 | 32 | 35 | 142 | 240 | 270 | 7.0 | M 16 SW 14 | 150 |
| 219.1 | Grip 219.1 | 216.0 - 221.0 | 16 | 32 | 35 | 142 | 250 | 280 | 7.3 | M 16 SW 14 | 150 |
| 225.0 | Grip 225.0 | 222.0 - 227.0 | 13 | 26.5 | 35 | 142 | 255 | 285 | 7.4 | M 16 SW 14 | 180 |
| 229.9 | Grip 229.9 | 228.0 - 232.0 | 13 | 26 | 35 | 142 | 260 | 290 | 7.5 | M 16 SW 14 | 180 |
| 244.5 | Grip 244.5 | 242.0 - 247.0 | 12 | 24.5 | 35 | 142 | 275 | 305 | 7.7 | M 16 SW 14 | 180 |
| 254.0 | Grip 254.0 | 250.0 - 256.0 | 11.5 | 22.5 | 35 | 142 | 285 | 315 | 7.9 | M 16 SW 14 | 180 |
| 267.0 | Grip 267.0 | 264.0 - 269.0 | 11 | 22.5 | 35 | 142 | 300 | 330 | 8.2 | M 16 SW 14 | 180 |
| 273.0 | Grip 273.0 | 270.0 - 275.0 | 11 | 22 | 35 | 142 | 305 | 335 | 8.3 | M 16 SW 14 | 180 |
| 306.0 | Grip 306.0 | 302.0 - 308.0 | 9.5 | 19.5 | 35 | 142 | 340 | 370 | 8.9 | M 16 SW 14 | 180 |
| 323.9 | Grip 323.9 | 320.0 - 327.0 | 6.5 | 13 | 35 | 142 | 355 | 385 | 9.2 | M 16 SW 14 | 180 |
| 326.0 | Grip 326.0 | 322.0 - 329.0 | 6.5 | 13 | 35 | 142 | 360 | 390 | 9.3 | M 16 SW 14 | 180 |
| 355.6 | Grip 355.6 | 352.0 - 359.0 | 6 | 12 | 35 | 142 | 390 | 420 | 9.8 | M 16 SW 14 | 180 |
| 406.4 | Grip 406.4 | 402.0 - 410.0 | 4.5 | 9 | 35 | 142 | 440 | 470 | 10.8 | M 16 SW 14 | 180 |
| 429.0 | Grip 429.0 | 426.0 - 431.0 | 4 | 8.5 | 35 | 142 | 460 | 490 | 11.3 | M 16 SW 14 | 180 |
| 442.0 | Grip 442.0 | 439.0 - 444.0 | 4 | 8 | 35 | 142 | 475 | 505 | 11.5 | M 16 SW 14 | 180 |
| 457.2 | Grip 457.2 | 454.0 - 459.0 | 4 | 8 | 35 | 142 | 490 | 520 | 11.8 | M 16 SW 14 | 180 |
| 508.0 | Grip 508.0 | 505.0 - 510.0 | 2.5 | 5 | 35 | 142 | 540 | 570 | 12.7 | M 16 SW 14 | 180 |
| 531.0 | Grip 531.0 | 528.0 - 534.0 | 2.5 | 5 | 35 | 142 | 565 | 595 | 13.2 | M 16 SW 14 | 180 |
| 558.8 | Grip 558.8 | 556.0 - 562.0 | 2 | 4.5 | 35 | 142 | 590 | 620 | 13.7 | M 16 SW 14 | 180 |
| 609.6 | Grip 609.6 | 606.0 - 613.0 | 1.5 | 3 | 35 | 142 | 640 | 670 | 14.7 | M 16 SW 14 | 180 |
| 634.0 | Grip 634.0 | 631.0 - 637.0 | 1.5 | 3 | 35 | 142 | 665 | 695 | 15.1 | M 16 SW 14 | 200 |
| 711.2 | Grip 711.2 | 707.0 - 715.0 | 1.5 | 2.5 | 35 | 142 | 745 | 775 | 16.6 | M 16 Sw 14 | 200 |

PN¹ (Nominal Pressure) is the max. admissible working pressure in shipbuilding, based on a safety factor of ≥ 4 .

WP² is the max. working pressure in industrial applications, with a safety factor as per NORMA specification.

Technical data & Ordering information

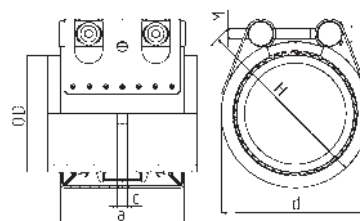

| NORMACONNECT® FGR GRIP | | | | | | | |
|------------------------|-------------|-------------------|---------------|-------------------|---------------|-------------------|---------------|
| Ø (O.D.) | Designation | W2 Product No. | | W4 Product No. | | W5 Product No. | |
| | | EPDM | NBR | EPDM | NBR | EPDM | NBR |
| 193.7 | Grip 193.7 | 0577 8100 193 | 0577 8400 193 | 0577 8200 193 | 0577 8500 193 | 0577 8300 193 | 0577 8600 193 |
| 206.0 | Grip 206.0 | 0577 8100 206 | 0577 8400 206 | 0577 8200 206 | 0577 8500 206 | 0577 8300 206 | 0577 8600 206 |
| 219.1 | Grip 219.1 | 0577 8100 219 | 0577 8400 219 | 0577 8200 219 | 0577 8500 219 | 0577 8300 219 | 0577 3600 219 |
| 225.0 | Grip 225.0 | 0577 8100 225 | 0577 8400 225 | 0577 8200 225 | 0577 8500 225 | 0577 8300 225 | 0577 8600 225 |
| 229.9 | Grip 229.9 | 0577 8100 229 | 0577 8400 229 | 0577 8200 229 | 0577 8500 229 | 0577 8300 229 | 0577 8600 229 |
| 244.5 | Grip 244.5 | 0577 8100 244 | 0577 8400 244 | 0577 8200 244 | 0577 8500 244 | 0577 8300 244 | 0577 8600 244 |
| 254.0 | Grip 254.0 | 0577 8100 254 | 0577 8400 254 | 0577 8200 254 | 0577 8500 254 | 0577 8300 254 | 0577 8600 254 |
| 267.0 | Grip 267.0 | 0577 8100 267 | 0577 8400 267 | 0577 8200 267 | 0577 8500 267 | 0577 8300 267 | 0577 8600 267 |
| 273.0 | Grip 273.0 | 0577 8100 273 | 0577 8400 273 | 0577 8200 273 | 0577 8500 273 | 0577 8300 273 | 0577 3600 273 |
| 306.0 | Grip 306.0 | 0577 8100 306 | 0577 8400 306 | 0577 8200 306 | 0577 8500 306 | 0577 8300 306 | 0577 8600 306 |
| 323.9 | Grip 323.9 | 0577 8100 323 | 0577 8400 323 | 0577 8200 323 | 0577 8500 323 | 0577 8300 323 | 0577 8600 323 |
| 326.0 | Grip 326.0 | 0577 8100 326 | 0577 8400 326 | 0577 8200 326 | 0577 8500 326 | 0577 8300 326 | 0577 8600 326 |
| 355.6 | Grip 355.6 | 0577 8100 355 | 0577 8400 355 | 0577 8200 355 | 0577 8500 355 | 0577 8300 355 | 0577 8600 355 |
| 406.4 | Grip 406.4 | 0577 8100 406 | 0577 8400 406 | 0577 8200 406 | 0577 8500 406 | 0577 8300 406 | 0577 8600 406 |
| 429.0 | Grip 429.0 | 0577 8100 429 | 0577 8400 429 | 0577 8200 429 | 0577 8500 429 | 0577 8300 429 | 0577 8600 429 |
| 442.0 | Grip 442.0 | 0577 8100 442 | 0577 8400 442 | 0577 8200 442 | 0577 8500 442 | 0577 8300 442 | 0577 8600 442 |
| 457.2 | Grip 457.2 | 0577 8100 457 | 0577 8400 457 | 0577 8200 457 | 0577 8500 457 | 0577 8300 457 | 0577 8600 457 |
| 508.0 | Grip 508.0 | 0577 8100 508 | 0577 8400 508 | 0577 8200 508 | 0577 8500 508 | 0577 8300 508 | 0577 8600 508 |
| 531.0 | Grip 531.0 | 0577 8100 531 | 0577 8400 531 | 0577 8200 531 | 0577 8500 531 | 0577 8300 531 | 0577 8600 531 |
| 558.8 | Grip 558.8 | 0577 8100 558 | 0577 8400 558 | 0577 8200 558 | 0577 8500 558 | 0577 8300 558 | 0577 8600 558 |
| 609.6 | Grip 609.6 | 0577 8100 609 | 0577 8400 609 | 0577 8200 609 | 0577 8500 609 | 0577 8300 609 | 0577 8600 609 |
| 634.0 | Grip 634.0 | 0577 8100 634 | 0577 8400 634 | 0577 8200 634 | 0577 8500 634 | 0577 8300 634 | 0577 8600 634 |
| 711.2 | Grip 711.2 | 0577 8100 711 | 0577 8400 711 | 0577 8200 711 | 0577 8500 711 | 0577 8300 711 | 0577 8600 711 |

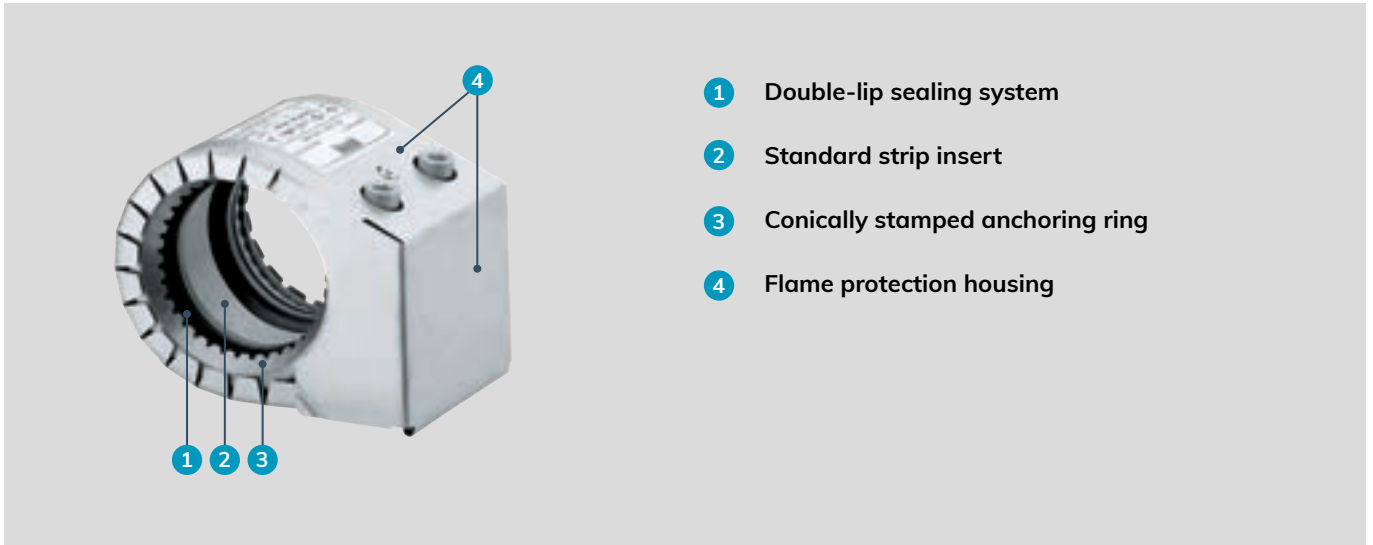

- 1 Double-lip sealing system
- 2 Standard strip insert
- 3 Conically stamped anchoring ring
- 4 Flame protection housing

The fire resistant coupling

NORMACONNECT® GRIP E-FP pipe couplings with integrated flame protection are used with applications in the marine sector (civil and military) as well as in sprinkler systems. For this purpose the GRIP E type has been equipped with an additional housing made from stainless steel plus a fire-resistant lining which can resist temperatures of 850 °C and upwards.

Advantages at a glance

- ✓ Dampens absorbing vibrations, pressure surges
- ✓ Weight saving
- ✓ Tension free
- ✓ Ready to install

Information

- Sizes: 26.9 mm – 219.1 mm
- Working pressure: 16.0 – 6.0 bar
- Material: AISI 304, AISI 316 Ti
- EPDM:
 - Sizes from 26.9 mm up to 168.3 mm: -30 °C up to +125 °C
 - Sizes > 180.0 mm: from -20 °C up to +80 °C
- NBR: from -20 °C up to +80 °C



Materials

| W1 | W2 | W3 | W4 | W5 |
|----|----|----|----|----|
| | | | | x |

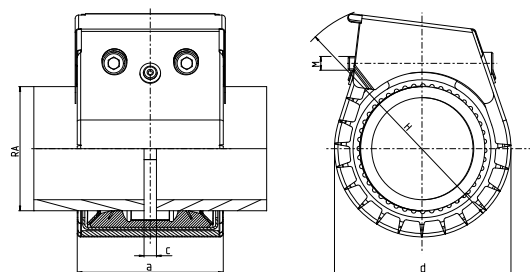
Technical data & ordering information



Technical data & Ordering information

| NORMACONNECT® FGR GRIP E-FP | | | | | | | | | | | | | |
|-----------------------------|-----------------|--------------------|--|--|--|-------------------------|-----------|-----------|---------------------|--------------------------|--------|------------------------------|---------------|
| Ø (O.D.) | Designation | Clamping ranges | PN ¹ (MAWP ¹ from dia- meter 180) | WP ¹ | C max | Dimensions (approx.) | | | Weight (approx.) | Hex socket locking bolts | | W5 Product No. | |
| | | | Odmin - Odmax (mm) |  [bar] |  [bar] | (mm) | a (mm) | d (mm) | H (mm) | (kg/pc.) | Thread | Tightening torque (Nm) | EPDM |
| 26.9 | Grip E-FP 26.9 | 26.4 - 27.5 | 16 | 70 | 3 | 67 | 60 | 110 | 0.42 | M 8 SW 6 | 10 | 0579 9370 026 | 0579 8670 026 |
| 28.0 | Grip E-FP 28.0 | 27.5 - 28.5 | 16 | 70 | 3 | 67 | 60 | 110 | 0.42 | M 8 SW 6 | 10 | 0579 9370 028 | 0579 8670 028 |
| 30.0 | Grip E-FP 30.0 | 29.5 - 30.6 | 16 | 70 | 3 | 67 | 60 | 110 | 0.42 | M 8 SW 6 | 10 | 0579 9370 030 | 0579 8670 030 |
| 33.7 | Grip E-FP 33.7 | 33.0 - 34.3 | 16 | 60 | 3 | 67 | 65 | 115 | 0.43 | M 8 SW 6 | 10 | 0579 9370 033 | 0579 8670 033 |
| 35.0 | Grip E-FP 35.0 | 34.5 - 35.6 | 16 | 60 | 8 | 75 | 65 | 115 | 0.58 | M 8 SW 6 | 15 | 0579 9370 035 | 0579 8670 035 |
| 38.0 | Grip E-FP 38.0 | 37.5 - 38.6 | 16 | 60 | 8 | 75 | 70 | 120 | 0.58 | M 8 SW 6 | 15 | 0579 9370 038 | 0579 8670 038 |
| 42.4 | Grip E-FP 42.4 | 41.7 - 43.0 | 16 | 50 | 8 | 75 | 75 | 125 | 0.59 | M 8 SW 6 | 15 | 0579 9370 042 | 0579 8670 042 |
| 44.5 | Grip E-FP 44.5 | 44.0 - 45.1 | 16 | 50 | 8 | 75 | 75 | 125 | 0.60 | M 8 SW 6 | 15 | 0579 9370 044 | 0579 8670 044 |
| 48.3 | Grip E-FP 48.3 | 47.6 - 50.5 | 16 | 50 | 8 | 75 | 80 | 130 | 0.61 | M 8 SW 6 | 15 | 0579 9370 048 | 0579 8670 048 |
| 54.0 | Grip E-FP 54.0 | 53.3 - 54.6 | 16 | 50 | 17 | 90 | 85 | 135 | 0.92 | M 8 SW 6 | 15 | 0579 9370 054 | 0579 8670 054 |
| 57.0 | Grip E-FP 57.0 | 56.3 - 57.7 | 16 | 50 | 17 | 90 | 90 | 140 | 0.93 | M 8 SW 6 | 20 | 0579 9370 057 | 0579 8670 057 |
| 60.3 | Grip E-FP 60.3 | 59.5 - 61.0 | 16 | 40 | 17 | 90 | 95 | 145 | 0.94 | M 8 SW 6 | 20 | 0579 9370 060 | 0579 8670 060 |
| 73.0 | Grip E-FP 73.0 | 72.1 - 73.8 | 16 | 40 | 17 | 90 | 95 | 145 | 0.94 | M 10 SW 8 | 30 | 0579 9370 073 | 0579 8670 073 |
| 76.1 | Grip E-FP 76.1 | 75.2 - 77.0 | 16 | 35 | 25 | 110 | 105 | 155 | 1.49 | M 10 SW 8 | 30 | 0579 9370 076 | 0579 8670 076 |
| 84.0 | Grip E-FP 84.0 | 83.0 - 85.0 | 16 | 35 | 25 | 110 | 110 | 160 | 1.49 | M 10 SW 8 | 30 | 0579 9370 084 | 0579 8670 084 |
| 88.9 | Grip E-FP 88.9 | 87.0 - 89.9 | 16 | 35 | 25 | 110 | 115 | 165 | 1.56 | M 10 SW 8 | 30 | 0579 9370 088 | 0579 8670 088 |
| 101.6 | Grip E-FP 101.6 | 100.4 - 102.8 | 16 | 35 | 25 | 110 | 120 | 170 | 1.59 | M 10 SW 8 | 30 | 0579 9370 101 | 0579 8670 101 |
| 104.0 | Grip E-FP 104.0 | 102.8 - 106.1 | 16 | 35 | 25 | 110 | 135 | 185 | 1.75 | M 10 SW 8 | 30 | 0579 9370 104 | 0579 8670 104 |
| 108.0 | Grip E-FP 108.0 | 106.8 - 109.2 | 16 | 35 | 25 | 110 | 135 | 185 | 1.76 | M 10 SW 8 | 30 | 0579 9370 108 | 0579 8670 108 |
| 110.0 | Grip E-FP 110.0 | 108.8 - 111.4 | 16 | 35 | 25 | 110 | 140 | 190 | 1.79 | M 10 SW 8 | 30 | 0579 9370 110 | 0579 8670 110 |
| 114.3 | Grip E-FP 114.3 | 113.0 - 115.5 | 16 | 35 | 25 | 110 | 145 | 195 | 1.89 | M 10 SW 8 | 40 | 0579 9370 114 | 0579 8670 114 |
| 129.0 | Grip E-FP 129.0 | 127.6 - 131.1 | 16 | 32 | 35 | 125 | 165 | 215 | 3.25 | M 12 SW 10 | 50 | 0579 9370 129 | 0579 8670 129 |
| 133.0 | Grip E-FP 133.0 | 131.5 - 134.4 | 16 | 32 | 35 | 125 | 170 | 220 | 3.36 | M 12 SW 10 | 50 | 0579 9370 133 | 0579 8670 133 |
| 139.7 | Grip E-FP 139.7 | 138.1 - 141.6 | 16 | 32 | 35 | 125 | 175 | 225 | 3.48 | M 12 SW 10 | 50 | 0579 9370 139 | 0579 8670 139 |
| 141.3 | Grip E-FP 141.3 | 139.6 - 142.8 | 16 | 32 | 35 | 125 | 180 | 230 | 3.48 | M 12 SW 10 | 50 | 0579 9370 141 | 0579 8670 141 |
| 154.0 | Grip E-FP 154.0 | 152.3 - 156.1 | 16 | 32 | 35 | 125 | 190 | 240 | 3.63 | M 12 SW 10 | 60 | 0579 9370 154 | 0579 8670 154 |
| 159.0 | Grip E-FP 159.0 | 157.3 - 160.7 | 16 | 32 | 35 | 125 | 195 | 245 | 3.75 | M 12 SW 10 | 60 | 0579 9370 159 | 0579 8670 159 |
| 168.3 | Grip E-FP 168.3 | 166.5 - 170.1 | 16 | 32 | 35 | 125 | 205 | 255 | 3.83 | M 12 SW 10 | 60 | 0579 9370 168 | 0579 8670 168 |
| 193.7 | Grip E-FP 193.7 | 192.0 - 196.0 | 10 | 20 | 35 | 125 | 235 | 285 | 6.9 | M 16 SW 14 | 100 | 0579 9370 193 | 0579 8670 193 |
| 206.0 | Grip E-FP 206.0 | 202.0 - 208.0 | 10 | 20 | 35 | 125 | 250 | 300 | 7.2 | M 16 SW 14 | 100 | 0579 9370 206 | 0579 8670 206 |
| 219.1 | Grip E-FP 219.1 | 216.0 - 221.0 | 10 | 20 | 35 | 125 | 260 | 310 | 7.4 | M 16 SW 14 | 100 | 0574 8370 219 | 0574 8670 219 |

PN¹ (Nominal Pressure) is the max. admissible working pressure in shipbuilding, based on a safety factor of ≥ 4 .

MAWP¹ (Maximum Allowable Working Pressure) is the max. admissible working pressure in shipbuilding, based on a safety factor of ≥ 4 .

WP² is the max. working pressure in industrial applications, with a safety factor as per NORMA specification.

Bigger dimensions available on request.



- 1 Metal housing made from AISI 316 Ti
- 2 Environmentally-friendly – No use of chemicals
- 3 Shoulders of the coupling are flame protected



Double-locked safeguards prevent accidental dismantling

RFP for application at shipbuilding

The NORMACONNECT® RFP is a retrofittable flame protector housing that has been specially designed for use with all NORMACONNECT® FLEX and GRIP pipe couplings. Its low weight and straightforward design allows quick, easy assembly without any tools. The built-in flame resistant mineral fiber mat provides a premium level of flame protection. The Retrofit Flame Protector (RFP) housing has been extensively tested and is approved by several international classification societies.

Advantages at a glance

- ✓ Retrofittable
- ✓ Easy assembly without tooling
- ✓ Low weight
- ✓ Meets current IACS requirements
- ✓ No chemicals in flame protection mat
- ✓ High flexibility
- ✓ Clear identification whether coupling is flame protected or not
- ✓ Mechanical stress resistant
- ✓ Less warehouse costs

Information

Sizes from 26.9 mm up to 273.0 mm

Materials

| | | | | |
|----|----|----|----|----|
| W1 | W2 | W3 | W4 | W5 |
| | | | | x |

Technical data & Ordering information

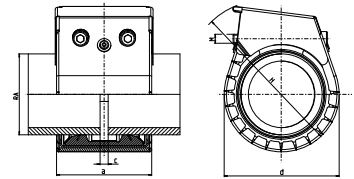

| NORMACONNECT® FGR RFP | | | | | | |
|-----------------------|---------------------|----------------------|--------|---------|------------------------------------|----------------|
| Ø (O.D.) | Designation | Dimensions (approx.) | | | Weight of RFP (approx.) (kg/piece) | W5 Product No. |
| | | a (mm) | d (mm) | H* (mm) | | |
| 26.9 | NC RFP W5 RFP 26.9 | 69 | 60 | 110 | 0.09 | 0573 0000 026 |
| 28.0 | NC RFP W5 RFP 28.0 | 69 | 60 | 110 | 0.09 | 0573 0000 028 |
| 30.0 | NC RFP W5 RFP 30.0 | 69 | 60 | 110 | 0.10 | 0573 0000 030 |
| 33.7 | NC RFP W5 RFP 33.7 | 69 | 65 | 115 | 0.10 | 0573 0000 033 |
| 38.0 | NC RFP W5 RFP 38.0 | 75 | 70 | 120 | 0.11 | 0573 0000 038 |
| 42.4 | NC RFP W5 RFP 42.4 | 75 | 75 | 125 | 0.12 | 0573 0000 042 |
| 44.5 | NC RFP W5 RFP 44.5 | 75 | 75 | 125 | 0.12 | 0573 0000 044 |
| 48.3 | NC RFP W5 RFP 48.3 | 75 | 80 | 130 | 0.13 | 0573 0000 048 |
| 54.0 | NC RFP W5 RFP 54.0 | 90 | 90 | 135 | 0.14 | 0573 0000 054 |
| 57.0 | NC RFP W5 RFP 57.0 | 90 | 90 | 140 | 0.16 | 0573 0000 057 |
| 60.3 | NC RFP W5 RFP 60.3 | 90 | 95 | 145 | 0.16 | 0573 0000 060 |
| 76.1 | NC RFP W5 RFP 76.1 | 110 | 110 | 160 | 0.24 | 0573 0000 076 |
| 88.9 | NC RFP W5 RFP 88.9 | 110 | 120 | 170 | 0.26 | 0573 0000 088 |
| 101.6 | NC RFP W5 RFP 101.6 | 110 | 135 | 185 | 0.28 | 0573 0000 101 |
| 104.0 | NC RFP W5 RFP 104.0 | 110 | 135 | 185 | 0.29 | 0573 0000 104 |
| 108.0 | NC RFP W5 RFP 108.0 | 110 | 140 | 190 | 0.30 | 0573 0000 108 |
| 114.3 | NC RFP W5 RFP 114.3 | 110 | 145 | 195 | 0.31 | 0573 0000 114 |
| 133.0 | NC RFP W5 RFP 133.0 | 125 | 170 | 220 | 0.41 | 0573 0000 133 |
| 139.7 | NC RFP W5 RFP 139.7 | 125 | 175 | 225 | 0.43 | 0573 0000 139 |
| 154.0 | NC RFP W5 RFP 154.0 | 125 | 190 | 240 | 0.45 | 0573 0000 154 |
| 159.0 | NC RFP W5 RFP 159.0 | 125 | 195 | 245 | 0.49 | 0573 0000 159 |
| 168.3 | NC RFP W5 RFP 168.3 | 125 | 205 | 255 | 0.50 | 0573 0000 168 |
| 219.1 | NC RFP W5 RFP 219.1 | 155 | 260 | 310 | 0.73 | 0573 0000 219 |

* Dimensions of the housing are given as assembled on a NORMACONNECT® Grip/ Grip E/ Flex/ Flex E pipe coupling. Further sizes available on request.

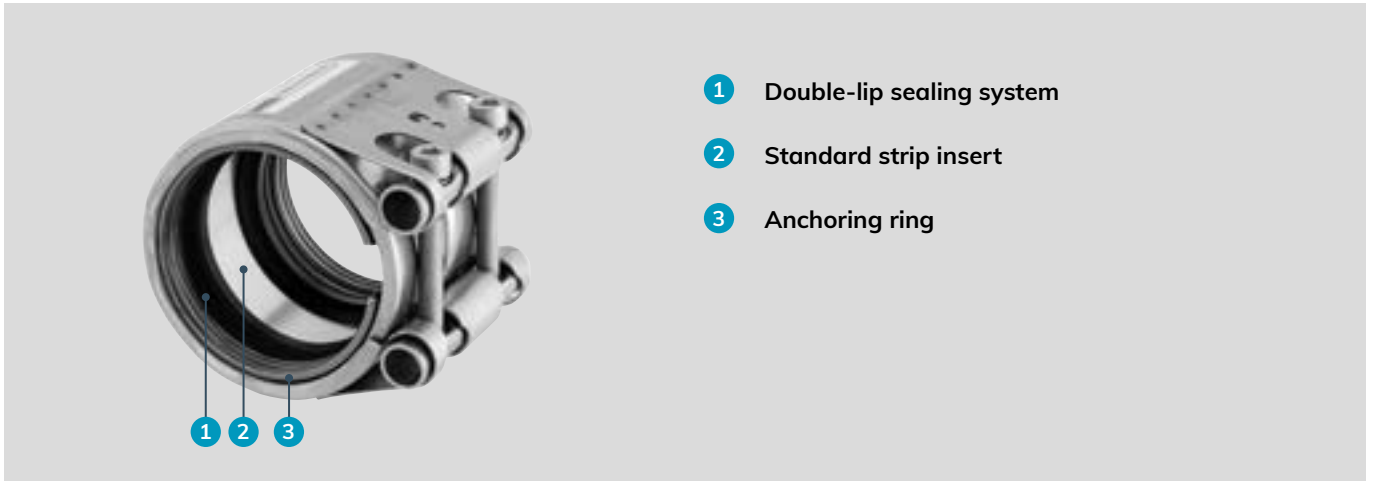

- 1 Double-lip sealing system
- 2 Standard strip insert
- 3 Anchoring ring

The coupling for plastic pipes

NORMACONNECT® PLAST GRIP/PLAST GRIP E axial restraint pipe couplings are used to connect plastic pipes. The specially designed anchoring ring, featuring flat rows of teeth, engages into the pipe surface without damaging the plastic material. The force applied is distributed evenly across the pipe surface. NORMACONNECT® PLAST GRIP E has hollow trunnions (smaller diameters). NORMACONNECT® PLAST GRIP has solid trunnions (larger diameters).

Advantages at a glance

- ✓ Also usable for smooth thermoplastics such as PP and PE.
- ✓ Also available with hollow trunnions for weight-saving

Information

- Sizes: 40.0 mm – 400.0 mm
- Working pressure: 16.0 – 6.0 bar
- Material: AISI 304, AISI 316 Ti
- EPDM:
 - Sizes from 40.0 mm up to 168.3 mm -30 °C up to +125 °C
 - Sizes > 180.0 mm: -20 °C up to +80 °C
- NBR: -20 °C up to +80 °C

Materials

| W1 | W2 | W3 | W4 | W5 |
|----|----|----|----|----|
| | | | | x |

Technical data & ordering information

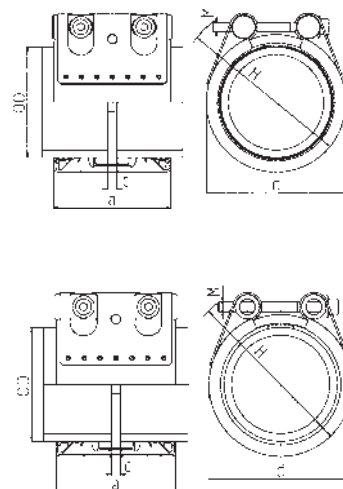



NORMACONNECT® PLAST GRIP/PLAST GRIP E axial restraint pipe couplings are used to connect plastic pipes.

Main advantage



- PLAST GRIP E has hollow trunnions and is weight-saving (available for smaller diameters)
- PLAST GRIP has solid trunnions (available for larger diameters)



Material

W5

NORMACONNECT®

Technical data & Ordering information

| NORMACONNECT® FGR PLAST GRIP E | | | | | | | | | | | | | |
|--------------------------------|---------------------|---------------------|---|---|-------|----------------------|--------|--------|------------------|--------------------------|------------------------|----------------|---------------|
| Ø (O.D.) | Designation | Clamping ranges | PN ¹ | WP ² | C max | Dimensions (approx.) | | | Weight (approx.) | Hex socket locking bolts | | W5 Product No. | |
| | | Oadmin - Odmax (mm) |  [bar] |  [bar] | (mm) | a (mm) | d (mm) | H (mm) | (kg/pc.) | Thread | Tightening torque (Nm) | EPDM | NBR |
| 40.0 | Plast Grip E W5 40 | 39.0 - 40.5 | 10 | 16 | 8 | 62 | 60 | 80 | 0.48 | M 8 SW 6 | 15 | 0581 9360 040 | 0581 8660 040 |
| 50.0 | Plast Grip E W5 50 | 49.0 - 50.5 | 10 | 16 | 8 | 62 | 70 | 90 | 0.52 | M 8 SW 6 | 15 | 0581 9360 050 | 0581 8660 050 |
| 63.0 | Plast Grip E W5 63 | 62.0 - 63.5 | 10 | 16 | 17 | 78 | 85 | 105 | 0.67 | M 8 SW 6 | 20 | 0581 9360 063 | 0581 8660 063 |
| 75.0 | Plast Grip E W5 75 | 74.0 - 76.0 | 10 | 16 | 25 | 98 | 100 | 120 | 1.33 | M 10 SW 8 | 30 | 0581 9360 075 | 0581 8660 075 |
| 90.0 | Plast Grip E W5 90 | 89.0 - 91.0 | 10 | 16 | 25 | 98 | 110 | 130 | 1.42 | M 10 SW 8 | 30 | 0581 9360 090 | 0581 8660 090 |
| 110.0 | Plast Grip E W5 110 | 109.0 - 111.0 | 10 | 16 | 25 | 98 | 130 | 150 | 1.66 | M 10 SW 8 | 30 | 0581 9360 110 | 0581 8660 110 |
| 125.0 | Plast Grip E W5 125 | 124.0 - 126.0 | 10 | 16 | 35 | 115 | 140 | 160 | 1.42 | M 12 SW 10 | 40 | 0581 9360 125 | 0581 8660 125 |
| 140.0 | Plast Grip E W5 140 | 139.0 - 141.0 | 10 | 16 | 35 | 115 | 160 | 180 | 1.18 | M 12 SW 10 | 50 | 0581 9360 140 | 0581 8660 140 |
| 154.0 | Plast Grip E W5 154 | 152.3 - 156.1 | 10 | 16 | 35 | 115 | 170 | 190 | 1.27 | M 12 SW 10 | 50 | 0581 9360 154 | 0581 8660 154 |
| 160.0 | Plast Grip E W5 160 | 159.0 - 162.0 | 10 | 16 | 35 | 115 | 180 | 200 | 1.45 | M 12 SW 10 | 60 | 0581 9360 160 | 0581 8660 160 |

| NORMACONNECT® FGR PLAST GRIP | | | | | | | | | | | | | |
|------------------------------|-------------------|---------------------|---|---|-------|----------------------|--------|--------|------------------|--------------------------|------------------------|----------------|---------------|
| Ø (O.D.) | Designation | Clamping ranges | PN ¹ | WP ² | C max | Dimensions (approx.) | | | Weight (approx.) | Hex socket locking bolts | | W5 Product No. | |
| | | Oadmin - Odmax (mm) |  [bar] |  [bar] | (mm) | a (mm) | d (mm) | H (mm) | (kg/pc.) | Thread | Tightening torque (Nm) | EPDM | NBR |
| 180.0 | Plast Grip W5 180 | 178.0 - 182.0 | - | 16 | 35 | 142 | 210 | 240 | 7.6 | M 12 SW 10 | 60 | 0581 8350 180 | 0581 8650 180 |
| 200.0 | Plast Grip W5 200 | 198.0 - 202.0 | - | 16 | 35 | 142 | 230 | 260 | 8.1 | M 12 SW 10 | 60 | 0581 8350 200 | 0581 8650 200 |
| 225.0 | Plast Grip W5 225 | 222.0 - 227.0 | - | 10 | 35 | 142 | 255 | 285 | 8.7 | M 12 SW 10 | 60 | 0581 8350 225 | 0581 8650 225 |
| 250.0 | Plast Grip W5 250 | 247.0 - 253.0 | - | 10 | 35 | 142 | 280 | 310 | 9.4 | M 12 SW 10 | 80 | 0581 8350 250 | 0581 8650 250 |
| 280.0 | Plast Grip W5 280 | 277.0 - 283.0 | - | 10 | 35 | 142 | 310 | 340 | 10.1 | M 16 SW 14 | 100 | 0581 8350 280 | 0581 8650 280 |
| 315.0 | Plast Grip W5 315 | 311.0 - 318.0 | - | 10 | 35 | 142 | 345 | 375 | 11 | M 16 SW 14 | 100 | 0581 8350 315 | 0581 8650 315 |
| 355.0 | Plast Grip W5 355 | 352.0 - 359.0 | - | 6 | 35 | 142 | 385 | 415 | 12 | M 16 SW 14 | 120 | 0581 8350 355 | 0581 8650 355 |
| 400.0 | Plast Grip W5 400 | 396.0 - 404.0 | - | 6 | 35 | 142 | 430 | 460 | 13.1 | M 16 SW 14 | 120 | 0581 8350 400 | 0581 8650 400 |

PN¹ (Nominal Pressure) is the max. admissible working pressure in shipbuilding, based on a safety factor of ≥ 4.
 WP² is the max. working pressure in industrial applications, with a safety factor as per NORMA specification.

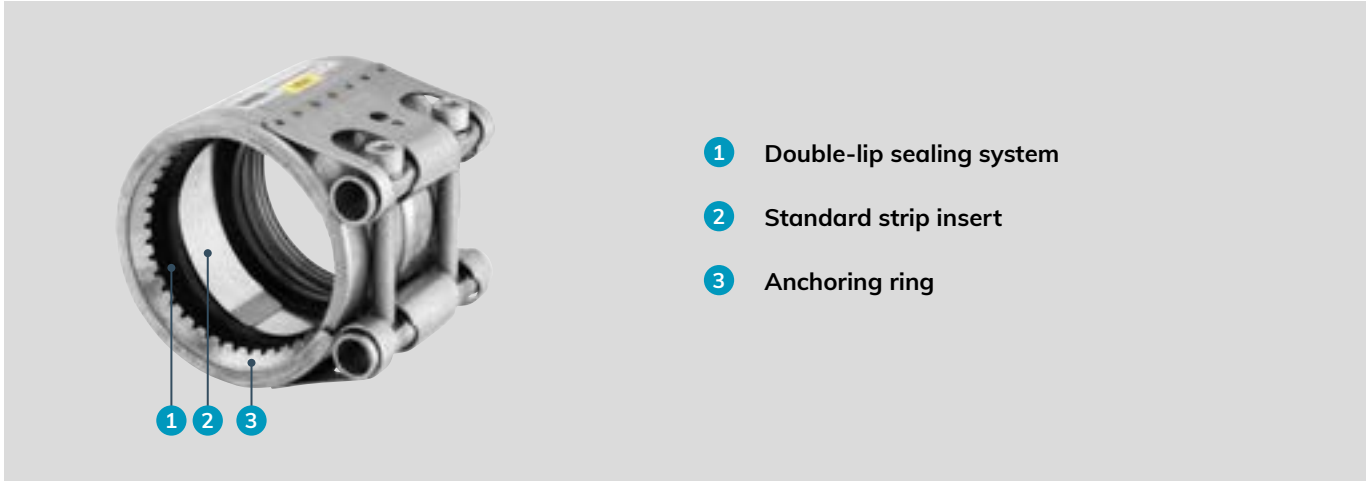

- 1 Double-lip sealing system
- 2 Standard strip insert
- 3 Anchoring ring

The combining pipe coupling

NORMACONNECT® COMBI GRIP/COMBI GRIP E axial restraint pipe couplings are used to connect plastic pipes with metal pipes.

On the side connecting the plastic pipe, the coupling has a special anchoring ring with rows of flat teeth which are pressed into the pipe surface without damaging the material. At the same time the force applied is distributed evenly across the pipe surface.

On the side connecting the metal pipe, the coupling has a different anchoring ring with conically stamped teeth which grip into the pipe surface. Due to the special design of the anchoring ring the coupling can withstand even high vibration loads. NORMACONNECT® COMBI GRIP E has hollow trunnions (smaller diameters). NORMACONNECT® COMBI GRIP has solid trunnions (larger diameters).

Advantages at a glance

- ✓ Corrosion resistant
- ✓ No welding
- ✓ No special tools necessary
- ✓ Installation and working in every kind of weather (hot and cold)
- ✓ Reusable

Information

- Sizes: from 38.0/40.0 mm to 400.0/406.0 mm
- Working pressure: 16.0 – 6.0 bar
- Material: AISI 304, AISI 316 Ti
- EPDM:
 - Sizes from 38.0 mm up to 160.0 mm: -30 °C up to +125 °C
 - Sizes > 200.0 mm: -20 °C up to +80 °C
- NBR: from -20 °C up to +80 °C

Materials

| W1 | W2 | W3 | W4 | W5 |
|----|----|----|----|----|
| | | | | x |

Technical data & Ordering information

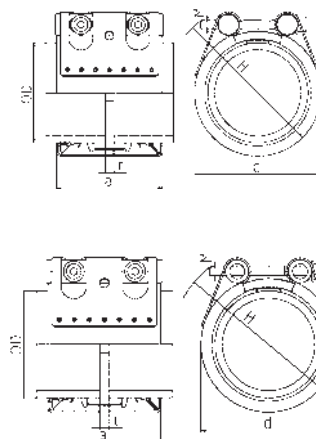



NORMACONNECT® COMBI GRIP/COMBI GRIP E axial restraint pipe couplings are used to connect plastic pipes with metal pipes.

Advantages at a glance



- COMBI GRIP E has hollow trunnions (smaller diameters)
- COMBI GRIP has solid trunnions (larger diameters)

Material

W5

NORMACONNECT®

Technical data & Ordering information

| NORMACONNECT® FGR COMBI GRIP E | | | | | | | | | | | | | | |
|--------------------------------|----------------------------|---|-------------|---|---|------------------|-------------------------|-----------|-----------|---------------------------------|-----------------------------|-----------------------------------|-------------------|---------------|
| Ø (O.D.) | Designation | Clamping ranges O _{dmin} - O _{dmax} (mm) | | PN ¹  [bar] | WP ²  [bar] | C max (mm) | Dimensions (approx.) | | | Weight (approx.) (kg/pc.) | Hex socket locking bolts | | W5 Product No. | |
| | | Plastic | Metal | | | | a (mm) | d (mm) | H (mm) | | Thread | Tight- ening torque (Nm) | EPDM | NBR |
| 38.0 / 40.0 | Combi Grip E 38.0 / 40.0 | 39.0-40.5 | 37.5-38.6 | 10 | 16 | 8 | 62 | 60 | 80 | 0.46 | M 8 SW 6 | 15 | 0584 9360 038 | 0584 8660 038 |
| 40.0 / 42.4 | Combi Grip E 40.0 / 42.4 | 39.0-40.5 | 41.7-43.0 | 10 | 16 | 8 | 62 | 65 | 85 | 0.47 | M 8 SW 6 | 15 | 0584 9360 042 | 0584 8660 042 |
| 50.0 / 48.3 | Combi Grip E 50.0 / 48.3 | 47.6-51.0 | 47.6-50.5 | 10 | 16 | 8 | 62 | 70 | 90 | 0.5 | M 8 SW 6 | 15 | 0584 9360 048 | 0584 8660 048 |
| 56.0 / 54.0* | Combi Grip E 56.0 / 54.0 | 55.0-56.5 | 53.3-54.6 | - | 5* | 17 | 78 | 80 | 100 | 0.62 | M 8 SW 6 | 15 | 0584 9360 054 | 0584 8660 054 |
| 63.0 / 60.3 | Combi Grip E 63.0 / 60.3 | 62.0-63.5 | 59.5-61.0 | 10 | 16 | 17 | 78 | 85 | 105 | 0.65 | M 8 SW 6 | 20 | 0584 9360 060 | 0584 8660 060 |
| 75.0 / 76.1 | Combi Grip E 75.0 / 76.1 | 74.0-76.0 | 75.2-77.0 | 10 | 16 | 25 | 98 | 100 | 120 | 1.3 | M 10 SW 8 | 30 | 0584 9360 076 | 0584 8660 076 |
| 90.0 / 88.9 | Combi Grip E 90.0 / 88.9 | 89.0-91.0 | 87.0-89.9 | 10 | 16 | 25 | 98 | 110 | 130 | 1.39 | M 10 SW 8 | 30 | 0584 9360 088 | 0584 8660 088 |
| 110.0 / 108.0 | Combi Grip E 110.0 / 108.0 | 109.0-111.0 | 106.8-109.2 | 10 | 16 | 25 | 98 | 130 | 150 | 1.58 | M 10 SW 8 | 40 | 0584 9360 108 | 0584 8660 108 |
| 110.0 / 114.3 | Combi Grip E 110.0 / 114.3 | 109.0-111.0 | 113.0-115.5 | 10 | 16 | 25 | 98 | 135 | 155 | 1.62 | M 10 SW 8 | 40 | 0584 9360 110 | 0584 8660 110 |
| 140.0 / 139.7 | Combi Grip E 140.0 / 139.7 | 139.0-141.0 | 138.1-141.6 | 10 | 16 | 35 | 115 | 160 | 180 | 3.14 | M 12 SW 10 | 50 | 0584 9360 139 | 0584 8660 139 |
| 160.0 / 159.0 | Combi Grip E 159.0 / 160.0 | 159.0-162.0 | 157.3-160.7 | 10 | 16 | 35 | 115 | 180 | 200 | 3.45 | M 12 SW 10 | 60 | 0584 9360 159 | 0584 8660 159 |

| NORMACONNECT® FGR COMBI GRIP | | | | | | | | | | | | | | |
|------------------------------|--------------------------|---|-------------|---|---|------------------|-------------------------|-----------|-----------|---------------------------------|-----------------------------|-----------------------------------|-------------------|---------------|
| Ø (O.D.) | Designation | Clamping ranges O _{dmin} - O _{dmax} (mm) | | PN ¹  [bar] | WP ²  [bar] | C max (mm) | Dimensions (approx.) | | | Weight (approx.) (kg/pc.) | Hex socket locking bolts | | W5 Product No. | |
| | | Plastic | Metal | | | | a (mm) | d (mm) | H (mm) | | Thread | Tight- ening torque (Nm) | EPDM | NBR |
| 200.0 / 204.0 | Combi Grip 200.0 / 204.0 | 198.0-202.0 | 202.0-206.0 | - | 16 | 35 | 142 | 235 | 265 | 7.5 | M 12 SW 10 | 60 | 0584 8350 204 | 0584 8650 204 |
| 225.0 / 219.1 | Combi Grip 225.0 / 219.1 | 222.0-227.0 | 216.0-221.0 | - | 10 | 35 | 142 | 255 | 285 | 8.1 | M 12 SW 10 | 60 | 0584 8350 220 | 0584 8650 220 |
| 225.0 / 222.0 | Combi Grip 225.0 / 222.0 | 222.0-227.0 | 220.0-224.0 | - | 10 | 35 | 142 | 255 | 285 | 8.1 | M 12 SW 10 | 60 | 0584 8350 222 | 0584 8650 222 |
| 250.0 / 254.0 | Combi Grip 250.0 / 254.0 | 247.0-253.0 | 250.0-256.0 | - | 10 | 35 | 142 | 285 | 315 | 8.6 | M 12 SW 10 | 80 | 0584 8350 254 | 0584 8650 254 |
| 280.0 / 273.0 | Combi Grip 280.0 / 273.0 | 277.0-283.0 | 270.0-275.0 | - | 10 | 35 | 142 | 310 | 340 | 9.3 | M 16 SW 14 | 100 | 0584 8350 273 | 0584 8650 273 |
| 355.0 / 355.6 | Combi Grip 355.0 / 355.6 | 351.0-359.0 | 352.0-359.0 | - | 6 | 35 | 142 | 390 | 420 | 10.9 | M 16 SW 14 | 120 | 0584 8350 355 | 0584 8650 355 |
| 400.0 / 406.4 | Combi Grip 400.0 / 406.4 | 396.0-404.0 | 402.0-410.0 | - | 6 | 35 | 142 | 440 | 470 | 11.9 | M 16 SW 14 | 120 | 0584 8350 400 | 0584 8650 400 |

PN¹ (Nominal Pressure) is the max. admissible working pressure in shipbuilding, based on a safety factor of ≥ 4.

WP² is the max. working pressure in industrial applications, with a safety factor as per NORMA specification.

* Special coupling for joining metal pipes with PE-HD drainage pipes



Support sleeve to be used with **NORMACONNECT® PLAST GRIP/PLAST GRIP E, COMBI GRIP GRIP E** in W5 (316Ti) material.

For copper and CuNiFe pipes an optional support sleeve made from brass is available on request.

Optional support sleeve

When joining plastic pipes made from PE and PP a support sleeve must be used. If the pipes to be joined are made from soft thermoplastic (e.g., PE) the use of a support sleeve is mandatory. The support sleeve is inserted into the pipe end within the area to be joined and thus protects the pipe from being deformed.

Technical data & Ordering information

| INTERNAL SUPPORT SLEEVE FOR PLAST GRIP / PLAST GRIP E IN W5 (316Ti)* | | | | | | |
|--|---------------|-------|---------------|-------|---------------|-------|
| PE | SDR 11 | | SDR 13.6 | | SDR 17 | |
| Ø OD mm | Product No. | Ø mm | Product No. | Ø mm | Product No. | Ø mm |
| 40 | 0581 0011 040 | 32.6 | 0581 0013 040 | 34.0 | 0581 0017 040 | 35.2 |
| 50 | 0581 0011 050 | 40.8 | 0581 0013 050 | 42.6 | 0581 0017 050 | 44.0 |
| 63 | 0581 0011 063 | 51.4 | 0581 0013 063 | 53.6 | 0581 0017 063 | 55.4 |
| 75 | 0581 0011 075 | 61.4 | 0581 0013 075 | 63.8 | 0581 0017 075 | 66.0 |
| 90 | 0581 0011 090 | 73.6 | 0581 0013 090 | 76.6 | 0581 0017 090 | 79.2 |
| 110 | 0581 0011 110 | 90.0 | 0581 0013 110 | 93.8 | 0581 0017 110 | 96.8 |
| 125 | 0581 0011 125 | 102.2 | 0581 0013 125 | 106.6 | 0581 0017 125 | 110.2 |
| 140 | 0581 0011 140 | 114.6 | 0581 0013 140 | 119.4 | 0581 0017 140 | 123.4 |
| 160 | 0581 0011 160 | 130.8 | 0581 0013 160 | 136.4 | 0581 0017 160 | 141.0 |
| 180 | 0581 0011 180 | 147.2 | 0581 0013 180 | 153.4 | 0581 0017 180 | 158.6 |
| 200 | 0581 0011 200 | 163.6 | 0581 0013 200 | 170.6 | 0581 0017 200 | 176.2 |
| 225 | 0581 0011 225 | 184.0 | 0581 0013 225 | 191.8 | 0581 0017 225 | 198.2 |
| 250 | 0581 0011 250 | 204.6 | 0581 0013 250 | 213.2 | 0581 0017 250 | 220.4 |
| 280 | 0581 0011 280 | 229.2 | 0581 0013 280 | 238.8 | 0581 0017 280 | 246.8 |
| 315 | 0581 0011 315 | 257.8 | 0581 0013 315 | 268.6 | 0581 0017 315 | 277.6 |
| 355 | 0581 0011 355 | 290.6 | 0581 0013 355 | 302.8 | 0581 0017 355 | 312.8 |
| 400 | 0581 0011 400 | 327.4 | 0581 0013 400 | 341.2 | 0581 0017 400 | 352.6 |
| 450 | 0581 0011 450 | | 0581 0013 450 | | 0581 0017 450 | |

Table continues on next page

* Other SDR classes on request.

Technical data & Ordering information

NORMA CONNECT®

| INTERNAL SUPPORT SLEEVE FOR PLAST GRIP / PLAST GRIP E IN W5 (316TI)* | | | | |
|--|---------------|-------|---------------|-------|
| PE | SDR 17.6 | | SDR 21 | |
| Ø OD mm | Product No. | Ø mm | Product No. | Ø mm |
| 40 | 0581 0018 040 | 35.4 | 0581 0021 040 | 36.0 |
| 50 | 0581 0018 050 | 44.2 | 0581 0021 050 | 45.2 |
| 63 | 0581 0018 063 | 55.8 | 0581 0021 063 | 57.0 |
| 75 | 0581 0018 075 | 66.4 | 0581 0021 075 | 67.8 |
| 90 | 0581 0018 090 | 79.8 | 0581 0021 090 | 81.4 |
| 110 | 0581 0018 110 | 97.4 | 0581 0021 110 | 99.4 |
| 125 | 0581 0018 125 | 110.8 | 0581 0021 125 | 113.0 |
| 140 | 0581 0018 140 | 124.0 | 0581 0021 140 | 126.6 |
| 160 | 0581 0018 160 | 141.8 | 0581 0021 160 | 144.6 |
| 180 | 0581 0018 180 | 159.6 | 0581 0021 180 | 162.8 |
| 200 | 0581 0018 200 | 177.2 | 0581 0021 200 | 180.8 |
| 225 | 0581 0018 225 | 199.4 | 0581 0021 225 | 203.4 |
| 250 | 0581 0018 250 | 221.6 | 0581 0021 250 | 226.2 |
| 280 | 0581 0018 280 | 248.2 | 0581 0021 280 | 253.2 |
| 315 | 0581 0018 315 | 279.2 | 0581 0021 315 | 285.0 |
| 355 | 0581 0018 355 | 314.8 | 0581 0021 355 | 321.2 |
| 400 | 0581 0018 400 | 354.6 | 0581 0021 400 | 361.8 |
| 450 | 0581 0018 450 | 399.0 | 0581 0021 450 | 407.0 |

* Other SDR classes on request

| INTERNAL SUPPORT SLEEVE FOR PLAST GRIP / PLAST GRIP E IN W5 (316TI)* | | | | | | |
|--|---------------|-------|---------------|-------|---------------|-------|
| PP | SDR 11 | | SDR 17 | | SDR 17.6 | |
| Ø OD mm | Product No. | Ø mm | Product No. | Ø mm | Product No. | Ø mm |
| 40 | 0581 1011 040 | 32.6 | 0581 1017 040 | 35.2 | 0581 1018 040 | 35.4 |
| 50 | 0581 1011 050 | 40.8 | 0581 1017 050 | 44.0 | 0581 1018 050 | 44.2 |
| 63 | 0581 1011 063 | 51.4 | 0581 1017 063 | 55.4 | 0581 1018 063 | 55.8 |
| 75 | 0581 1011 075 | 61.4 | 0581 1017 075 | 66.0 | 0581 1018 075 | 66.4 |
| 90 | 0581 1011 090 | 73.6 | 0581 1017 090 | 79.2 | 0581 1018 090 | 79.8 |
| 110 | 0581 1011 110 | 90.0 | 0581 1017 110 | 96.8 | 0581 1018 110 | 97.4 |
| 125 | 0581 1011 125 | 102.2 | 0581 1017 125 | 110.2 | 0581 1018 125 | 110.8 |
| 140 | 0581 1011 140 | 114.6 | 0581 1017 140 | 123.4 | 0581 1018 140 | 124.0 |
| 160 | 0581 1011 160 | 130.8 | 0581 1017 160 | 141.0 | 0581 1018 160 | 141.8 |
| 180 | 0581 1011 180 | 147.2 | 0581 1017 180 | 158.6 | 0581 1018 180 | 159.6 |
| 200 | 0581 1011 200 | 163.6 | 0581 1017 200 | 176.2 | 0581 1018 200 | 177.2 |
| 225 | 0581 1011 225 | 184.0 | 0581 1017 225 | 198.2 | 0581 1018 225 | 199.4 |
| 250 | 0581 1011 250 | 204.6 | 0581 1017 250 | 220.4 | 0581 1018 250 | 221.6 |
| 280 | 0581 1011 280 | 229.2 | 0581 1017 280 | 246.8 | 0581 1018 280 | 248.2 |
| 315 | 0581 1011 315 | 257.8 | 0581 1017 315 | 277.6 | 0581 1018 315 | 279.2 |
| 355 | 0581 1011 355 | 290.6 | 0581 1017 355 | 312.8 | 0581 1018 355 | 314.8 |
| 400 | 0581 1011 400 | 327.4 | 0581 1017 400 | 352.6 | 0581 1018 400 | 354.6 |
| 450 | 0581 1011 450 | 368.2 | 0581 1017 450 | 396.6 | 0581 1018 450 | 399.0 |

* Other SDR classes on request



- 1 Double-lip sealing system
- 2 Standard strip insert

The repair coupling

NORMACONNECT® REP E are non-restraint repair couplings. They are used to seal damaged metal and plastic pipes. They also enable repairs to be carried out easily, quickly and safely without the need to dismantle the pipes.

Advantages at a glance

- ✔ Ensures a reliable, safe, leakage-free seal of pipe damages
- ✔ Enables easy, quick and safe repair without dismantling the pipes
- ✔ Easy to install without special tools

Information

- Sizes: from 35.0 mm to 1219.1 mm
- Working pressure: from 60.0 bar to 4.0 bar
- Material: AISI 316 Ti
- EPDM:
 Sizes from 35.0 mm up to 168.3 mm: -30 °C up to +125 °C
 Sizes > 180.0 mm: -20 °C up to +80 °C
- NBR : from -20 °C up to +80 °C

Materials

| | | | | |
|----|----|----|----|----|
| W1 | W2 | W3 | W4 | W5 |
| | | | | x |

Technical data & Ordering information

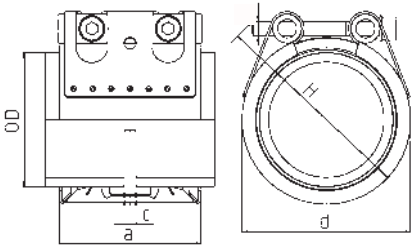

Technical data & Ordering information

| NORMACONNECT® FGR REP E | | | | | | | | | | | | |
|-------------------------|-----------------|--|---|-------|----------------------|--------|--------|------------------|--------------------------|------------------------|----------------|---------------|
| Ø (O.D.) | Designation | Clamping ranges | WP ¹ | C max | Dimensions (approx.) | | | Weight (approx.) | Hex socket locking bolts | | W5 Product No. | |
| | | O _{dmin} - O _{dmax} (mm) |  [bar] | (mm) | a (mm) | d (mm) | H (mm) | (kg/pc.) | Thread | Tightening torque (Nm) | EPDM | NBR |
| 35.0 | Rep E W5 35.0 | 34.5 - 35.6 | 60 | 8 | 63 | 55 | 75 | 0.41 | M 8 SW 6 | 5 | 0572 9360 035 | 0572 8660 035 |
| 38.0 | Rep E W5 38.0 | 37.5 - 38.6 | 60 | 8 | 63 | 60 | 80 | 0.41 | M 8 SW 6 | 5 | 0572 9360 038 | 0572 8660 038 |
| 42.4 | Rep E W5 42.4 | 41.7 - 43.0 | 50 | 8 | 63 | 65 | 85 | 0.42 | M 8 SW 6 | 5 | 0572 9360 042 | 0572 8660 042 |
| 44.5 | Rep E W5 44.5 | 44.0 - 45.1 | 50 | 8 | 63 | 65 | 85 | 0.43 | M 8 SW 6 | 5 | 0572 9360 044 | 0572 8660 044 |
| 48.3 | Rep E W5 48.3 | 47.6 - 50.5 | 50 | 8 | 63 | 70 | 90 | 0.44 | M 8 SW 6 | 5 | 0572 9360 048 | 0572 8660 048 |
| 54.0 | Rep E W5 54.0 | 53.3 - 54.6 | 50 | 17 | 78 | 75 | 95 | 0.58 | M 8 SW 6 | 10 | 0572 9360 054 | 0572 8660 054 |
| 57.0 | Rep E W5 57.0 | 56.3 - 57.7 | 50 | 17 | 78 | 80 | 100 | 0.58 | M 8 SW 6 | 10 | 0572 9360 057 | 0572 8660 057 |
| 60.3 | Rep E W5 60.3 | 59.5 - 61.0 | 40 | 17 | 78 | 85 | 105 | 0.59 | M 8 SW 6 | 10 | 0572 9360 060 | 0572 8660 060 |
| 70.0 | Rep E W5 70.0 | 69.0 - 71.0 | 40 | 25 | 98 | 90 | 110 | 0.59 | M 8 SW 6 | 10 | 0572 9360 070 | 0572 8660 070 |
| 73.0 | Rep E W5 73.0 | 72.1 - 73.8 | 40 | 25 | 98 | 95 | 115 | 1.13 | M 8 SW 6 | 10 | 0572 9360 073 | 0572 8660 073 |
| 76.1 | Rep E W5 76.1 | 75.2 - 77.0 | 35 | 25 | 98 | 100 | 120 | 1.13 | M 8 SW 6 | 10 | 0572 9360 076 | 0572 8660 076 |
| 78.0 | Rep E W5 78.0 | 77.1 - 78.9 | 35 | 25 | 98 | 100 | 120 | 1.14 | M 8 SW 6 | 15 | 0572 9360 078 | 0572 8660 078 |
| 80.0 | Rep E W5 80.0 | 79.0 - 80.8 | 35 | 25 | 98 | 100 | 120 | 1.16 | M 8 SW 6 | 15 | 0572 9360 080 | 0572 8660 080 |
| 84.0 | Rep E W5 84.0 | 83.0 - 85.0 | 35 | 25 | 98 | 105 | 125 | 1.18 | M 8 SW 6 | 15 | 0572 9360 084 | 0572 8660 084 |
| 88.9 | Rep E W5 88.9 | 87.0 - 89.9 | 35 | 25 | 98 | 110 | 130 | 1.20 | M 8 SW 6 | 15 | 0572 9360 088 | 0572 8660 088 |
| 101.6 | Rep E W5 101.6 | 100.4 - 102.8 | 35 | 25 | 98 | 125 | 145 | 1.33 | M 8 SW 6 | 15 | 0572 9360 101 | 0572 8660 101 |
| 104.0 | Rep E W5 104.0 | 102.8 - 106.1 | 35 | 25 | 98 | 125 | 145 | 1.36 | M 8 SW 6 | 15 | 0572 9360 104 | 0572 8660 104 |
| 108.0 | Rep E W5 108.0 | 106.8 - 109.2 | 35 | 25 | 98 | 130 | 150 | 1.40 | M 8 SW 6 | 15 | 0572 9360 108 | 0572 8660 108 |
| 110.0 | Rep E W5 110.0 | 108.8 - 111.4 | 35 | 25 | 98 | 130 | 150 | 1.40 | M 8 SW 6 | 20 | 0572 9360 110 | 0572 8660 110 |
| 114.3 | Rep E W5 114.0 | 113.0 - 115.5 | 35 | 25 | 98 | 135 | 155 | 1.99 | M 8 SW 6 | 30 | 0572 9360 114 | 0572 8660 114 |
| 129.0 | Rep E W5 129.0 | 127.6 - 131.1 | 32 | 35 | 113 | 155 | 185 | 2.00 | M 10 SW 8 | 30 | 0572 9360 129 | 0572 8660 129 |
| 133.0 | Rep E W5 133.0 | 131.5 - 134.4 | 32 | 35 | 113 | 160 | 190 | 2.03 | M 10 SW 8 | 30 | 0572 9360 133 | 0572 8660 133 |
| 139.7 | Rep E W5 139.7 | 138.1 - 141.6 | 32 | 35 | 113 | 165 | 195 | 2.08 | M 10 SW 8 | 30 | 0572 9360 139 | 0572 8660 139 |
| 141.3 | Rep E W5 141.3 | 139.6 - 142.8 | 32 | 35 | 113 | 170 | 200 | 2.09 | M 10 SW 8 | 35 | 0572 9360 141 | 0572 8660 141 |
| 154.0 | Rep E W5 154.0 | 152.3 - 156.1 | 32 | 35 | 113 | 180 | 210 | 2.19 | M 10 SW 8 | 50 | 0572 9360 154 | 0572 8660 154 |
| 159.0 | Rep E W5 159.0 | 157.3 - 160.7 | 32 | 35 | 113 | 185 | 215 | 2.26 | M 10 SW 8 | 50 | 0572 9360 159 | 0572 8660 159 |
| 168.3 | Rep E W5 168.0 | 166.5 - 170.1 | 32 | 35 | 113 | 195 | 225 | 2.31 | M 10 SW 8 | 50 | 0572 9360 168 | 0572 8660 168 |
| 180.0 | Rep E W5 180.0 | 178.0 - 182.0 | 30.0 | 35 | 139 | 210 | 240 | 4.0 | M 12 SW 10 | 25 | 0576 8360 180 | 0576 8660 180 |
| 193.7 | Rep E W5 193.7 | 192.0 - 196.0 | 28.0 | 35 | 139 | 225 | 255 | 4.1 | M 12 SW 10 | 25 | 0576 8360 193 | 0576 8660 193 |
| 206.0 | Rep E W5 206.0 | 202.0 - 208.0 | 26.5 | 35 | 139 | 240 | 270 | 4.3 | M 12 SW 10 | 25 | 0576 8360 206 | 0576 8660 206 |
| 219.0 | Rep E W5 219.0 | 216.0 - 221.0 | 23.0 | 35 | 139 | 250 | 280 | 4.4 | M 12 SW 10 | 25 | 0576 8360 219 | 0576 8660 219 |
| 225.0 | Rep E W5 225.0 | 222.0 - 227.0 | 23.0 | 35 | 139 | 255 | 285 | 4.5 | M 12 SW 10 | 25 | 0576 8360 225 | 0576 8660 225 |
| 229.9 | Rep E W5 229.9 | 228.0 - 232.0 | 23.0 | 35 | 139 | 260 | 290 | 4.5 | M 12 SW 10 | 25 | 0576 8360 229 | 0576 8660 229 |
| 244.5 | Rep E W5 244.5 | 242.0 - 247.0 | 22.0 | 35 | 139 | 275 | 305 | 4.7 | M 12 SW 10 | 25 | 0576 8360 244 | 0576 8660 244 |
| 254.0 | Rep E W5 254.0 | 250.0 - 256.0 | 21.0 | 35 | 139 | 285 | 315 | 4.8 | M 12 SW 10 | 25 | 0576 8360 254 | 0576 8660 254 |
| 267.0 | Rep E W5 267.0 | 264.0 - 269.0 | 20.0 | 35 | 139 | 300 | 330 | 5.0 | M 12 SW 10 | 25 | 0576 8360 267 | 0576 8660 267 |
| 273.0 | Rep E W5 273.0 | 270.0 - 275.0 | 20.0 | 35 | 139 | 305 | 335 | 5.1 | M 12 SW 10 | 25 | 0576 8360 273 | 0576 8660 273 |
| 306.0 | Rep E W5 306.0 | 302.0 - 308.0 | 17.5 | 35 | 139 | 340 | 370 | 5.5 | M 12 SW 10 | 25 | 0576 8360 306 | 0576 8660 306 |
| 323.9 | Rep E W5 323.9 | 320.0 - 327.0 | 17.5 | 35 | 139 | 355 | 385 | 5.7 | M 12 SW 10 | 25 | 0576 8360 323 | 0576 8660 323 |
| 326.0 | Rep E W5 326.0 | 322.0 - 329.0 | 16.5 | 35 | 139 | 360 | 390 | 5.7 | M 12 SW 10 | 25 | 0576 8360 326 | 0576 8660 326 |
| 355.6 | Rep E W5 355.6 | 352.0 - 359.0 | 15.0 | 35 | 139 | 390 | 420 | 6.0 | M 12 SW 10 | 25 | 0576 8360 355 | 0576 8660 355 |
| 406.4 | Rep E W5 406.4 | 402.0 - 410.0 | 14.0 | 35 | 139 | 440 | 470 | 6.6 | M 12 SW 10 | 25 | 0576 8360 406 | 0576 8660 406 |
| 429.0 | Rep E W5 429.0 | 426.0 - 431.0 | 13.0 | 35 | 139 | 460 | 490 | 6.9 | M 12 SW 10 | 40 | 0576 8360 429 | 0576 8660 429 |
| 442.0 | Rep E W5 442.0 | 439.0 - 444.0 | 13.0 | 35 | 139 | 475 | 505 | 7.1 | M 12 SW 10 | 40 | 0576 8360 442 | 0576 8660 442 |
| 457.2 | Rep E W5 457.2 | 454.0 - 459.0 | 12.0 | 35 | 139 | 490 | 520 | 7.3 | M 12 SW 10 | 40 | 0576 8360 457 | 0576 8660 457 |
| 508.0 | Rep E W5 508.0 | 505.0 - 510.0 | 11.0 | 35 | 139 | 540 | 570 | 7.9 | M 12 SW 10 | 40 | 0576 8360 508 | 0576 8660 508 |
| 531.0 | Rep E W5 531.0 | 528.0 - 534.0 | 10.5 | 35 | 139 | 565 | 595 | 8.1 | M 12 SW 10 | 40 | 0576 8360 531 | 0576 8660 531 |
| 558.8 | Rep E W5 558.8 | 556.0 - 562.0 | 10.0 | 35 | 139 | 590 | 620 | 8.5 | M 12 SW 10 | 40 | 0576 8360 558 | 0576 8660 558 |
| 609.6 | Rep E W5 609.6 | 606.0 - 613.0 | 9.0 | 35 | 139 | 640 | 670 | 9.1 | M 12 SW 10 | 40 | 0576 8360 609 | 0576 8660 609 |
| 634.0 | Rep E W5 634.0 | 631.0 - 637.0 | 8.0 | 35 | 139 | 665 | 695 | 9.4 | M 12 SW 10 | 40 | 0576 8360 634 | 0576 8660 634 |
| 711.2 | Rep E W5 711.2 | 707.0 - 715.0 | 7.0 | 35 | 139 | 745 | 775 | 10.3 | M 12 SW 10 | 40 | 0576 8360 711 | 0576 8668 711 |
| 762.0 | Rep E W5 762.0 | 758.0 - 766.0 | 7.0 | 35 | 139 | 795 | 825 | 10.9 | M 12 SW 10 | 40 | 0576 8360 762 | 0576 8668 762 |
| 812.8 | Rep E W5 812.8 | 808.0 - 817.0 | 6.5 | 35 | 139 | 845 | 875 | 11.5 | M 12 SW 10 | 40 | 0576 8368 812 | 0576 8668 812 |
| 914.4 | Rep E W5 914.4 | 909.0 - 919.0 | 5.5 | 35 | 139 | 945 | 975 | 12.7 | M 12 SW 10 | 45 | 0576 8368 914 | 0576 8668 914 |
| 1016.0 | Rep E W5 1016.0 | 1013.0 - 1019.0 | 5.0 | 35 | 139 | 1050 | 1080 | 13.9 | M 12 SW 10 | 45 | 0576 8368 016 | 0576 8668 016 |
| 1117.5 | Rep E W5 1117.5 | 1114.0 - 1120.0 | 4.5 | 35 | 139 | 1150 | 1180 | 15.1 | M 12 SW 10 | 50 | 0576 8368 117 | 0576 8668 117 |
| 1219.2 | Rep E W5 1219.2 | 1216.0 - 1222.0 | 4.0 | 35 | 139 | 1250 | 1280 | 16.3 | M 12 SW 10 | 50 | 0576 8368 219 | 0576 8668 219 |

Coupling sizes > 800 mm are in 2-parts design! Sizes > 1219.2 on request

NORMACONNECT®



Certificates, Liability, Memberships

Certificates

Materialprüfungsamt Nordrhein-Westfalen (MPA NRW)

Liability

Product liability: In case of bodily injury and/or material damage.

Memberships

IZEG – Informationszentrum Entwässerungstechnik Guss
 GEG – Gütergemeinschaft Entwässerungstechnik Guss



Informationszentrum
 Entwässerungstechnik Guss e.V.









Materials at a glance

| Materials for connectors and claws | | | | |
|------------------------------------|-------------|---------------|--------------------------|----------------|
| | Codllar | Clamping unit | Screws, Nuts, Bolts | Sealing sleeve |
| W1 | | | Steel, protected surface | – |
| W2 | AISI 430 Ti | AISI 304 | Steel, protected surface | EPDM |
| W4 | AISI 304 | AISI 304 | AISI 304 | EPDM |
| W5 | AISI 316 Ti | AISI 316 Ti | AISI 316 | EPDM |

| Materials for NORMACONNECT® pipe couplings | | | | |
|--|-------------|--------------------------|--------------------------|----------------|
| | Collar | Clamping unit | Screws | Sealing sleeve |
| W2 | AISI 304 | Steel, protected surface | Steel, protected surface | EPDM |
| W5 | AISI 316 Ti | AISI 316 Ti | AISI 316 | EPDM |

Products and Application at a glance

| TYPE | DN and Pressure [bar] | | | | | | | | | | | | | | Seal Type | Material | Application | | | | |
|--|-----------------------|----|----|----|------|-------|-----|-----|-----|-----|-----|-----|-----|-----|-----------|----------|-------------|-----------|------------|---------|------|
| | 40 | 50 | 70 | 75 | 75 S | 75/80 | 100 | 125 | 150 | 200 | 250 | 300 | 400 | 500 | | | 600 | Stand-ard | Build-ings | Bridges | Soil |
| NON-PULL-OUT resistant connections | | | | | | | | | | | | | | | | | | | | | |
| RAPID  | | • | • | | | • | • | • | • | • | | | | | | | EPDM | W 2 | • | - | - |
| RAPID  | | • | • | | | • | • | • | • | • | • | | | | | | EPDM | W 5 | • | • | • |
| MSM RAPID  | | • | • | | | • | • | • | • | • | | | | | | | EPDM | W 2 | • | - | - |
| Pull-out resistant connections | | | | | | | | | | | | | | | | | | | | | |
| UNIVERSAL Claw *  | | 10 | 10 | | | 10 | 10 | 10 | 5 | 5 | 3 | 3 | | | | | - | W 2 | • | - | - |
| RECORD Claw *  | | 10 | 10 | | | 10 | 10 | 5 | 5 | 3 | | | | | | | - | W 1 | • | - | - |
| COMBI Claw *  | | 10 | 10 | | | 10 | 10 | 5 | 5 | 5 | 3 | 3 | | | | | - | W 1 | • | - | - |
| Changeover connectors | | | | | | | | | | | | | | | | | | | | | |
| CONFIX  | | • | • | | | • | • | • | | | | | | | | | EPDM | - | • | - | - |

Technical Changes reserved

* The claws are only suitable for open drainage systems. It is not allowed for use in closed pressure systems.



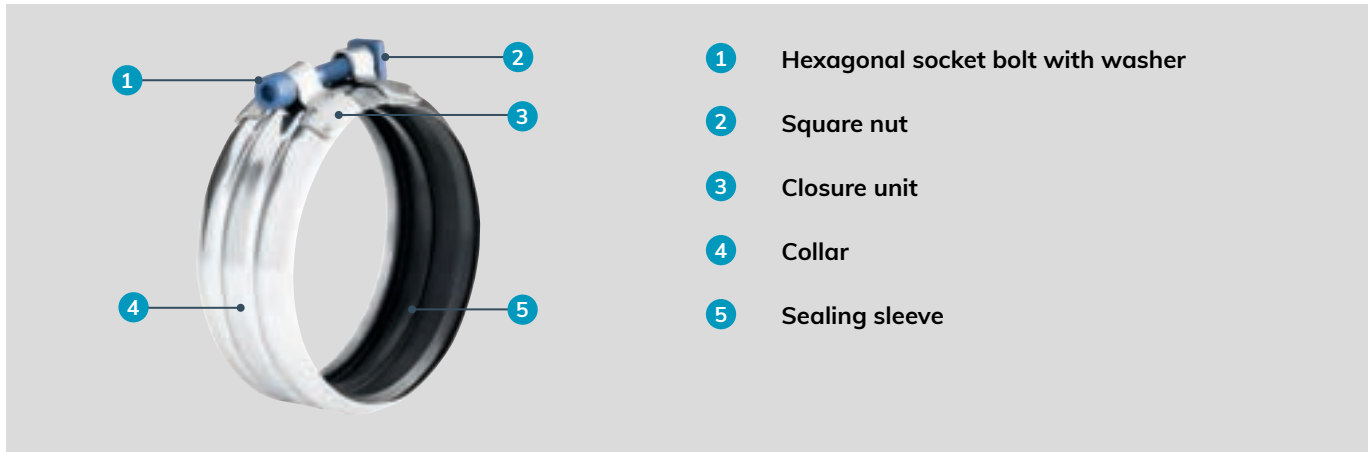

The original Rapid with block tightening

The NORMACONNECT® DCS RAPID with block tightening for non-pull-out resistant connections enables a fast connection. The visible torque control and the single-bolt closure provide for a fast and easy installation. Our DCS RAPID is the perfect solution to connect drainage fittings and pipes made of cast iron acc. to EN 877.

Materials

| | | | | |
|----|----|----|----|----|
| W1 | W2 | W3 | W4 | W5 |
| | x | | | x |

W2

- Material, Collar: AISI 430 Ti
- Material, Clamping unit: AISI 304 / AISI 430 Ti
- Material, Bolts/Nuts: Steel, surface protected
- Material, Sealing sleeve: EPDM

W5

- Material, Collar: AISI 316Ti
- Material, Clamping unit: AISI 316Ti
- Material, Bolts/Nuts, Steel, surface protected
- Material, Sealing sleeve: EPDM

Information

- DN 50 – DN 200: Resisting axial pull-out forces up to max. 0.5 bar
- DN 250 – DN 300: Resisting axial pull-out forces up to max. 0.3 bar
- Defined locking torque without using a special tool
- Meeting the fire protection requirements

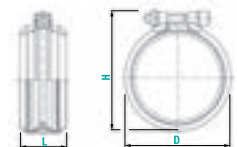

Technical data & Ordering information

| NORMACONNECT® DCS RAPID | | | | | | | | | |
|-------------------------|----------------------------------|--------|--------|--------|-------------|---------------|-----------|----------------|----------------|
| Designation | Max. Dimensions after Assembly ~ | | | | | | | W2 Product No. | W5 Product No. |
| | DN | D (mm) | H (mm) | L (mm) | P max (bar) | Torque (Nm) | Bolt (mm) | | |
| RAPID DN 50 | 50 | 70 | 80 | 46 | 0.5 | Tight-Locking | M 8 | 0245 8218 050 | 0245 8126 050 |
| RAPID DN 70 | 70 | 90 | 100 | 43 | 0.5 | Tight-Locking | M 8 | 0245 8219 070 | 0245 8127 070 |
| RAPID DN 75 S | 75 | 87 | 97 | 40.5 | 0.5 | Tight-Locking | M 8 | 0245 8265 075 | |
| RAPID DN 80 | 75/80 | 95 | 105 | 40 | 0.5 | Tight-Locking | M 8 | 0245 8220 080 | 0245 8129 075 |
| RAPID DN 100 | 100 | 125 | 135 | 39.0 | 0.5 | Tight-Locking | M 8 | 0245 8221 100 | 0245 8130 100 |
| RAPID DN 125 | 125 | 147 | 162 | 37.0 | 0.5 | Tight-Locking | M 8 | 0245 8222 125 | 0245 8131 125 |
| RAPID DN 150 | 150 | 172 | 187 | 35.5 | 0.5 | Tight-Locking | M 8 | 0245 8223 150 | 0245 8132 150 |
| RAPID DN 200 | 200 | 227 | 244 | 33.5 | 0.5 | Tight-Locking | M 10 | 0245 8224 200 | 0245 8133 200 |
| RAPID DN 250 | 250 | 293 | 306 | 96 | 0.3 | Tight-Locking | M 10 | | 0245 8208 250 |
| RAPID DN 300 | 300 | 345 | 360 | 96 | 0.3 | Tight-Locking | M 10 | | 0245 8209 300 |

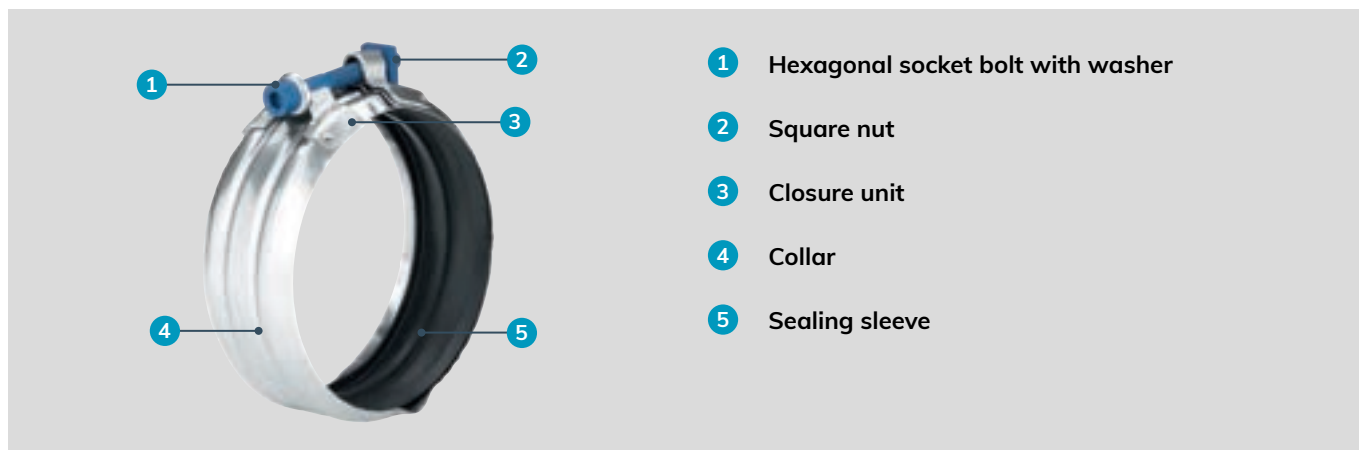

The fast connection with quick release closure

The NORMACONNECT® DCS RAPID MSM connection is easy-fitting and thus especially suitable for repair purposes. It is the fast connection with quick release closure for non-pull-out resistant connections.



NORMACONNECT®

Materials

| W1 | W2 | W3 | W4 | W5 |
|----|----|----|----|----|
| | x | | | |

W2

- Material, Collar: AISI 430 Ti
- Material, Clamping unit: AISI 304 / AISI 430 Ti
- Material, Bolts/Nuts: Steel, surface protected
- Material, Sealing sleeve: EPDM

Information

- Resisting axial pull-out forces up to max. 0.5 bar
- Defined locking torque without using a special tool
- Meeting the fire protection requirements

Technical data & Ordering information

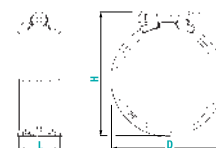

| NORMACONNECT® DCS RAPID MSM | | | | | | | | |
|-----------------------------|----------------------------------|-----------|-----------|-----------|----------------|----------------|--------------|-------------------|
| Designation | Max. Dimensions after Assembly ~ | | | | | | | W2 Product No. |
| | DN | D (mm) | H (mm) | L (mm) | P max (bar) | Torque (Nm) | Bolt (mm) | |
| RAPID DN 50 MSM | 50 | 70 | 80 | 40 | 0.5 | Tight-Locking | M 8 | 0245 8257 050 |
| RAPID DN 70 MSM | 70 | 90 | 100 | 40 | 0.5 | Tight-Locking | M 8 | 0245 8258 070 |
| RAPID DN 80 MSM | 75/80 | 95 | 105 | 40 | 0.5 | Tight-Locking | M 8 | 0245 8260 080 |
| RAPID DN 100 MSM | 100 | 125 | 135 | 46 | 0.5 | Tight-Locking | M 8 | 0245 8261 100 |
| RAPID DN 125 MSM | 125 | 147 | 162 | 55 | 0.5 | Tight-Locking | M 8 | 0245 8262 125 |
| RAPID DN 150 MSM | 150 | 172 | 187 | 55 | 0.5 | Tight-Locking | M 8 | 0245 8263 150 |
| RAPID DN 200 MSM | 200 | 227 | 244 | 70 | 0.5 | Tight-Locking | M 10 | 0245 8264 200 |

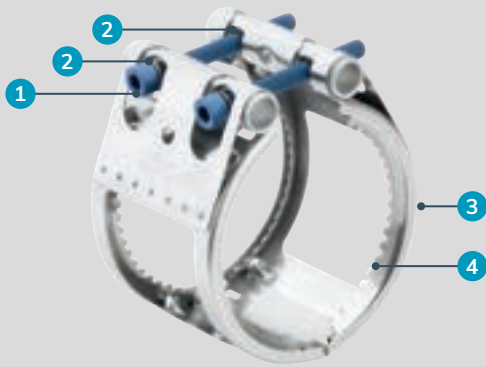

- 1 Hexagonal socket bolts
- 2 Hollow locking bars
- 3 Housing
- 4 Grip ring insert

NORMACONNECT®

The powerful add-on claw

Combined with either DCS RAPID or DCS RAPID MSM standards connectors, our NORMACONNECT® DCS Universal Claw is an axial restraint claw which resists high tensile loads. The grip-type coupling resists high tensile loads for non-pull-out resistant connections.



Materials

| | | | | |
|----|----|----|----|----|
| W1 | W2 | W3 | W4 | W5 |
| | x | | | |

W2

- Material, Housing: AISI 430 Ti
- Material, Closure unit: Steel, surface protected
- Material, Grip ring: AISI 301

Information

Recommended for use in combination with types RAPID/ RAPID MSM: up to max. 10 bar

Technical data & Ordering information

| NORMACONNECT® DCS Universal CLAW | | | | | | | | |
|----------------------------------|-------|--------|--------|--------|-----------|-------------------|---------------|----------------|
| Designation | DN | A (mm) | D (mm) | H (mm) | Bolt (mm) | P max (bar) | | W2 Product No. |
| | | | | | | RAPID / RAPID MSM | Torque (Nm) | |
| Universal Claw DN 50 | 50 | 77 | 85 | 105 | M 8 | 10 | Tight-Locking | 0262 8401 050 |
| Universal Claw DN 70 | 70 | 77 | 100 | 120 | M 8 | 10 | Tight-Locking | 0262 8402 070 |
| Universal Claw DN 75S | 75 | 77 | 100 | 120 | M 8 | 10 | Tight-Locking | 0262 8404 075 |
| Universal Claw DN 80 | 75/80 | 77 | 105 | 125 | M 8 | 10 | Tight-Locking | 0262 8403 080 |
| Universal Claw DN 100 | 100 | 97 | 130 | 150 | M 10 | 10 | Tight-Locking | 0262 8405 100 |
| Universal Claw DN 125 | 125 | 97 | 165 | 195 | M 10 | 10 | Tight-Locking | 0262 8406 125 |
| Universal Claw DN 150 | 150 | 97 | 185 | 215 | M 10 | 5 | Tight-Locking | 0262 8407 150 |
| Universal Claw DN 200 | 200 | 113 | 240 | 270 | M 12 | 5 | Tight-Locking | 0262 8415 200 |
| Universal Claw DN 250 | 250 | 139 | 305 | 335 | M 12 | 3 | Tight-Locking | 0262 8416 250 |
| Universal Claw DN 300 | 300 | 139 | 400 | 490 | M 12 | 3 | Tight-Locking | 0262 8417 300 |

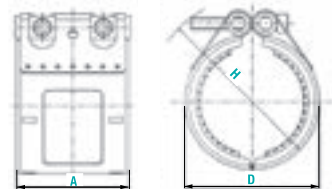

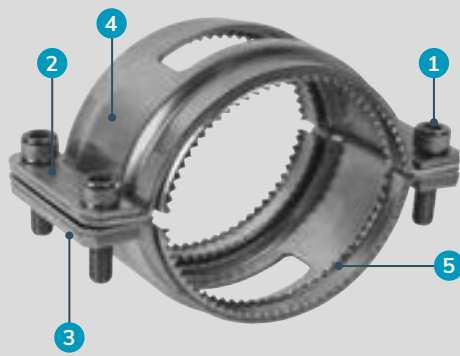

- 1 Hexagonal socket bolt with fine pitch thread
- 2 Guiding plate
- 3 Threaded plate
- 4 Housing
- 5 Grip ring insert (hardened)

The claw which resists high tensile loads

Axial restraint safety claw for use with pressurized pump lines in lifting systems as well as for rainwater sewage lines that are at risk of undergoing back pressures, but only in combination with the NORMACONNECT® DCS RAPID standard connectors. The powerful add-on claw for non-pull-out resistant connections.

Materials

| W1 | W2 | W3 | W4 | W5 |
|----|----|----|----|----|
| x | | | | |

W1

- Material, Housing: Steel, surface protected
- Material, Closure unit: Steel, surface protected

Advantages at a glance

- ✓ Two parts (halves) with hardened grip ring inserts
- ✓ Strong guiding plates with threaded holes plus four hexagonal socket bolts with fine pitch thread

Technical data & Ordering information

| NORMACONNECT® DCS RECORD CLAW | | | | | | | | |
|-------------------------------|-------|--------|--------|--------|-------------|-----------|-------------|----------------|
| Designation | DN | A (mm) | D (mm) | L (mm) | Torque (Nm) | Bolt (mm) | P max (bar) | W1 Product No. |
| RECORD Claw DN 50 | 50 | 21 | 75 | 69 | 12-15 | M 8 | up to 10 | 0262 1265 050 |
| RECORD Claw DN 70 | 70 | 21 | 95 | 69 | 12-15 | M 8 | up to 10 | 0262 1266 070 |
| RECORD Claw DN 80 | 75/80 | 21 | 100 | 69 | 12-15 | M 8 | up to 10 | 0262 1287 080 |
| RECORD Claw DN 100 | 100 | 25 | 135 | 87 | 25-30 | M 10 | up to 10 | 0262 1246 100 |
| RECORD Claw DN 125 | 125 | 25 | 160 | 95 | 30-35 | M 10 | up to 5 | 0262 1267 125 |
| RECORD Claw DN 150 | 150 | 25 | 185 | 95 | 30-35 | M 10 | up to 5 | 0262 1268 150 |
| RECORD Claw DN 200 | 200 | 30 | 235 | 111 | 60-65 | M 12 | up to 3 | 0262 1269 200 |

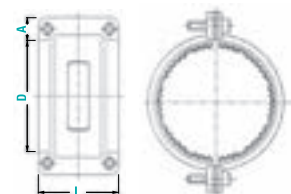

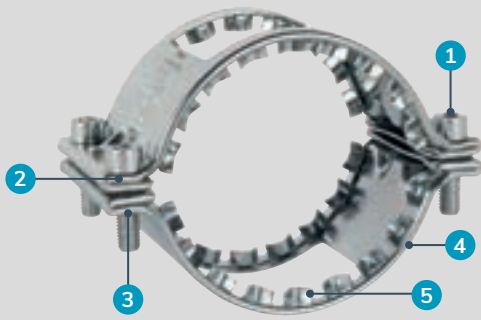

- 1 Hexagonal socket bolts
- 2 Guiding side
- 3 Threaded side
- 4 Housing
- 5 Anchoring teeth

NORMACONNECT®

The claw which resists high tensile loads

Our NORMACONNECT® DCS Combi Claw is an axial restraint safety claw for connecting rainwater and sewage lines that are at risk of undergoing back pressures. It is used in combination with NORMACONNECT® RAPID/RAPID MSM and standard connectors. The powerful add-on claw for non-pull-out resistant connections.

Materials

| | | | | |
|----|----|----|----|----|
| W1 | W2 | W3 | W4 | W5 |
| x | | | | |

Information

- Axial restraint up to 10 bar
- Diameters DN 50 up to DN 300

W1

- Material, Housing: Steel, surface protected
- Material, Closure unit: Steel, surface protected

Technical data & Ordering information

| NORMACONNECT® DCS COMBI CLAW | | | | | | | | |
|------------------------------|-----|--------|--------|--------|-------------|-----------|-------------|----------------|
| Designation | DN | D (mm) | A (mm) | L (mm) | Torque (Nm) | Bolt (mm) | P max (bar) | W1 Product No. |
| COMBI Claw DN 50 | 50 | 76 | 18 | 72 | 20 | M8 | up to 10 | 0262 8590 050 |
| COMBI Claw DN 80 | 80 | 99 | 18 | 72 | 20 | M8 | up to 10 | 0262 8590 080 |
| COMBI Claw DN 100 | 100 | 130 | 21 | 82 | 25 | M10 | up to 10 | 0262 8591 100 |
| COMBI Claw DN 125 | 125 | 156 | 21 | 96 | 25 | M10 | up to 8 | 0262 8592 125 |
| COMBI Claw DN 150 | 150 | 180 | 21 | 96 | 25 | M10 | up to 8 | 0262 8592 150 |
| COMBI Claw DN 200 | 200 | 235 | 27 | 110 | 65 | M 12 | up to 5 | 0262 8592 200 |
| COMBI Claw DN 250 | 250 | 285 | 27 | 130 | 65 | M 12 | up to 3 | 0262 8592 250 |
| COMBI Claw DN 300 | 300 | 335 | 27 | 130 | 65 | M 12 | up to 3 | 0262 8592 300 |

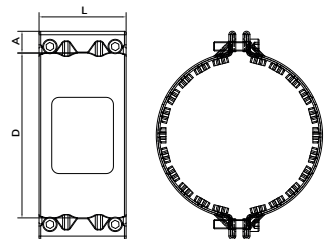



- 1 Easy handling
- 2 Strong worm-drive hose clamp

The changeover connector with 2 lip seals

The NORMACONNECT® CONFIX is a flexible connection which adapts to different pipe dimensions and materials.

NORMACONNECT®

Materials

| | | | | |
|----|----|----|----|----|
| W1 | W2 | W3 | W4 | W5 |
| | x | | | |

Material, Connector: EPDM
 Material, Worm-drive hose clamp band: AISI 430

Main advantage

- ✔ The connection of feed or suction lines to a pipe – either made of steel or plastics – is easily and safely achieved with the CONFIX connector.

Technical data & Ordering information

| NORMACONNECT® DCS CONFIX, EPDM with TORRO W2, Changeover Connector | | | | | | | | | | | |
|--|-----|---------|---------|---------|---------|---------|---------|---------|---------|----------------------|----------------|
| Designation | DN | D1 (mm) | D3 (mm) | D4 (mm) | D5 (mm) | D7 (mm) | L1 (mm) | L3 (mm) | L8 (mm) | Insertion depth (mm) | W2 Product No. |
| CONFIX DN 50 | 50 | 72 | 56 | 30 | 67.5 | 57 | 63 | 19 | 19 | 42 | 0245 9003 050 |
| CONFIX DN 70 | 70 | 92 | 75 | 41 | 86.5 | 77 | 77 | 19 | 24 | 55 | 0245 9003 070 |
| CONFIX DN 80 56-75 | 80 | 92 | 75 | 41 | 91 | 81 | 77 | 19 | 24 | 55 | 0245 9003 075 |
| CONFIX DN 80 75-90 | 80 | 108 | 90 | 58 | 93 | 81 | 88 | 19 | 23 | 60 | 0245 9003 080 |
| CONFIX DN 100 | 100 | 128 | 110 | 78 | 118 | 108 | 95 | 21 | 23 | 65 | 0245 9003 100 |
| CONFIX DN 125 | 125 | 145 | 126 | 90 | 145 | 132 | 103 | 26 | 27 | 75 | 0245 9003 125 |

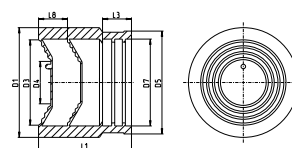

Dimensions of pipes and fittings to EN 877

| Dimensions of pipes and fittings to EN 877 | | | | |
|--|-----------------------|--------------|----------------|---------------|
| DN | Outside Diameter (OD) | | Wall Thickness | |
| | Nominal value | Tolerances | Nominal value | Minimum value |
| 40 | 48 | +2 -1 | 3.0 | 2.5 |
| 50 | 58 | +2 -1 | 3.5 | 3.0 |
| 70 | 78 | +2 -1 | 3.5 | 3.0 |
| 75/80 | 83 | +2 -1 | 3.5 | 3.0 |
| 100 | 110 | +2 -1 | 3.5 | 3.0 |
| 125 | 135 | +2 -2 | 4.0 | 3.5 |
| 150 | 160 | +2 -2 | 4.0 | 3.5 |
| 200 | 210 | +2.5 -2.5 | 5.0 | 4.0 |
| 250 | 274 | +2.5 -2.5 | 5.5 | 4.5 |
| 300 | 326 | +2.5 -2.5 | 6.0 | 5.0 |
| 400 | 429 | +2 -3 | 6.3 | 5.0 |
| 500 | 532 | +2 -3.5 | 7.0 | 5.2 |
| 600 | 635 | +2 -4 | 7.7 | 5.8 |

Dimensions in mm

NORMA CONNECT®



COMPRESSION FITTINGS

NORMA high-performance compression fittings

- ✓ Leakage-free connection for maximum water savings
- ✓ Excellent performance even under harsh conditions
- ✓ Highest durability for better system reliability



Find all details on our irrigation website:
norma-irrigation.com

NEW

QuickTight Technology
NORMA MARLIN®*

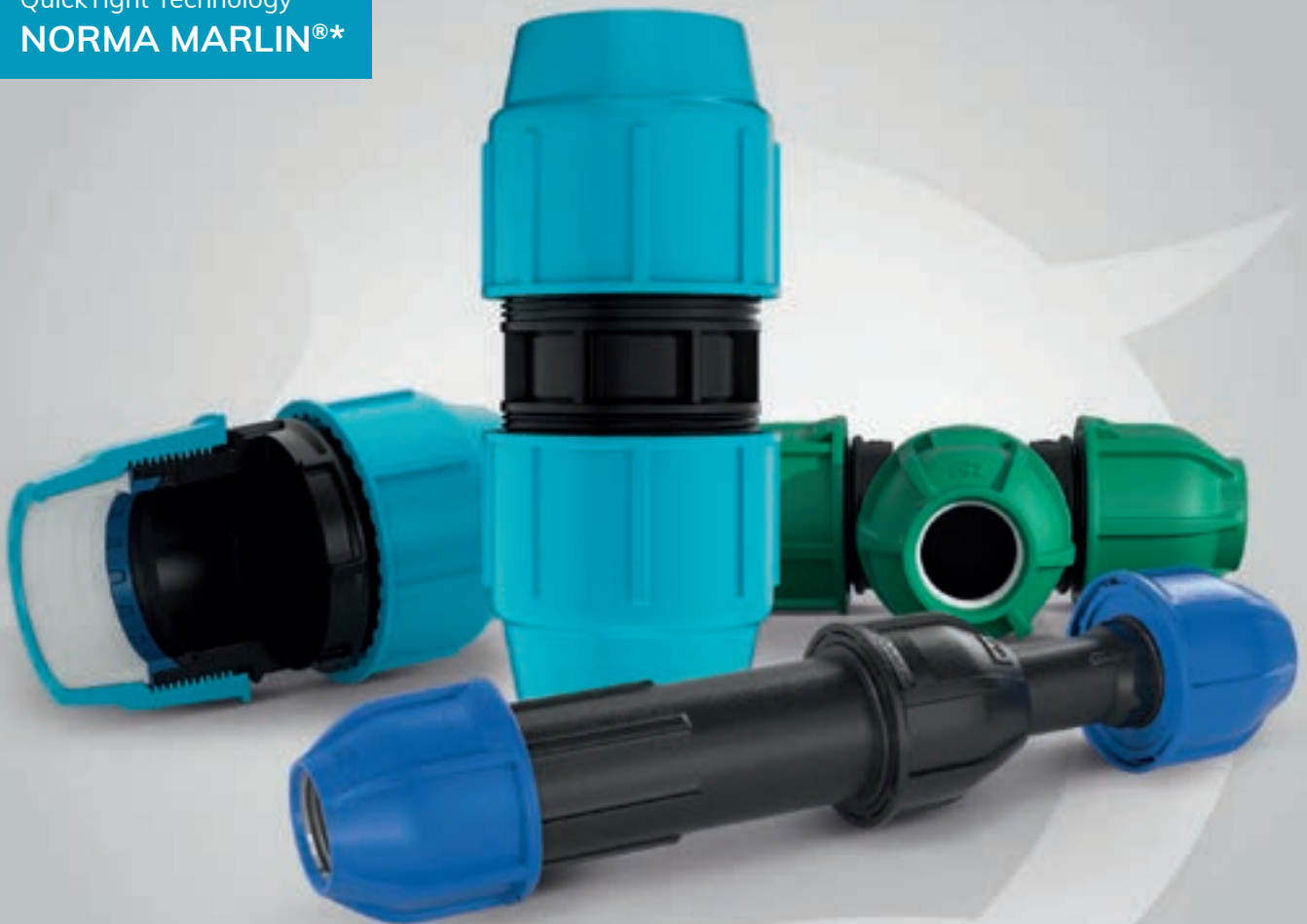

* Up to 50 % faster installations
Drinking water certified

Speed up your water pipe installations with QuickTight Technology!



NORMA MARLIN® PN 16

- Certified for drinking water
- Push fit installation in all sizes
- Faster and easier installation
- Lip-gasket technology for superior performance

More information:
norma-irrigation.com

Save time when repairing a broken pipe!



NORMA® Telescopic Fittings

- Ideal connection for repairing and taping into a PE pipe
- Dual O-rings are used to ensure leakage-free connections
- No additional components required for fixing the pipe
- Extensible telescopic function for easy and fast repair

More information:
norma-irrigation.com

High-performance compression fittings by NORMA



NORMA® PN 16

- Ideal for high-pressure applications
- Perfect water tightness
- Fast and easy connection
- Locking nut for clinching system

More information on
the following pages!

Cost-competitive high-quality compression fittings for your needs



NORMA® PN 10

- No special tooling required
- Easy connection
- High UV and temperature resistance
- Safe and durable

More information:
norma-irrigation.com



- 1 Male threaded adaptor – MA
- 2 Straight coupler – SC
- 3 Female threaded adaptor – FA
- 4 Flange adaptor – FLA
- 5 Equal bend – EB
- 6 Male threaded elbow – MB
- 7 Female threaded elbow – FB
- 8 Male threaded tee – MT
- 9 Female threaded tee – FT

NORMACONNECT®

PN 16 for non-potable water

NORMA® Compression Fittings are made of polypropylene for high-and-low density polyethylene tubing, diameters 16 to 110 mm. Maximum service pressure: PN 16* bar from diameter 16 to diameter 63 – PN 12.5 bar from diameter 75 to diameter 110. DOES NOT INCLUDE hot water application. NORMA® products are made in factories certified under ISO 9001 Version 2008.

Advantages at a glance

- ✓ Safe and durable
- ✓ Fast and easily connected
- ✓ Perfect water tightness
- ✓ Locking nut for a clinching system
- ✓ Simple insertion of the tube in the fitting
- ✓ No special workforce required
- ✓ High resistance to temperature and ultraviolet shocks

Applications

- Watering: Residential, municipal, sport fields, golf courses.
- Irrigation: Agriculture, horticulture, vineyards.
- Industry: Compressed air.



* PN 10 version available in our water management catalogue
Simply download the catalogue here: www.norma-irrigation.com

Information

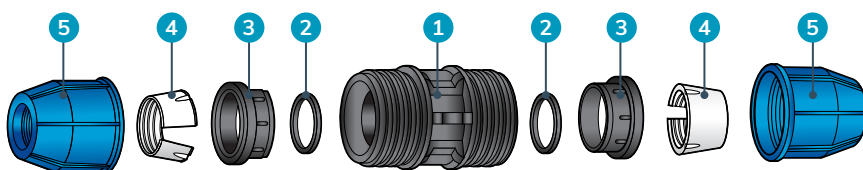

- 1 Body of Polypropylene
- 2 O-ring of NBR
- 3 Holder of Polypropylene
- 4 Clinching Ring of POM, acetal
- 5 Locking nut of Polypropylene

Male threaded adaptor – MA



NORMACONNECT®

| Size mm x inch | Designation | Polypropylene homopolymer Product No. |
|----------------|--|---------------------------------------|
| 16 x 1/2" | MALE THREADED ADAPTOR (MA) 16 x 1/2" | 0796 2601 111 |
| 16 x 3/4" | MALE THREADED ADAPTOR (MA) 16 x 3/4" | 0796 2601 112 |
| 20 x 1/2" | MALE THREADED ADAPTOR (MA) 20 x 1/2" | 0796 2651 118 |
| 20 x 3/4" | MALE THREADED ADAPTOR (MA) 20 x 3/4" | 0796 2651 120 |
| 20 x 1" | MALE THREADED ADAPTOR (MA) 20 x 1" | 0796 2651 117 |
| 25 x 1/2" | MALE THREADED ADAPTOR (MA) 25 x 1/2" | 0796 2651 121 |
| 25 x 3/4" | MALE THREADED ADAPTOR (MA) 25 x 3/4" | 0796 2651 122 |
| 25 x 1" | MALE THREADED ADAPTOR (MA) 25 x 1" | 0796 2651 124 |
| 32 x 1/2" | MALE THREADED ADAPTOR (MA) 32 x 1/2" | 0796 2651 126 |
| 32 x 3/4" | MALE THREADED ADAPTOR (MA) 32 x 3/4" | 0796 2651 127 |
| 32 x 1" | MALE THREADED ADAPTOR (MA) 32 x 1" | 0796 2651 128 |
| 32 x 1 1/4" | MALE THREADED ADAPTOR (MA) 32 x 1 1/4" | 0796 2651 130 |
| 40 x 3/4" | MALE THREADED ADAPTOR (MA) 40 x 3/4" | 0796 2651 131 |
| 40 x 1" | MALE THREADED ADAPTOR (MA) 40 x 1" | 0796 2651 132 |
| 40 x 1 1/4" | MALE THREADED ADAPTOR (MA) 40 x 1 1/4" | 0796 2651 133 |
| 40 x 1 1/2" | MALE THREADED ADAPTOR (MA) 40 x 1 1/2" | 0796 2651 134 |
| 50 x 1 1/4" | MALE THREADED ADAPTOR (MA) 50 x 1 1/4" | 0796 2651 135 |
| 50 x 1 1/2" | MALE THREADED ADAPTOR (MA) 50 x 1 1/2" | 0796 2651 136 |
| 50 x 2" | MALE THREADED ADAPTOR (MA) 50 x 2" | 0796 2651 137 |
| 63 x 1 1/2" | MALE THREADED ADAPTOR (MA) 63 x 1 1/2" | 0796 2651 138 |
| 63 x 2" | MALE THREADED ADAPTOR (MA) 63 x 2" | 0796 2651 139 |
| 75 x 2" | MALE THREADED ADAPTOR (MA) 75 x 2" | 0796 2640 310 |
| 75 x 2 1/2" | MALE THREADED ADAPTOR (MA) 75 x 2 1/2" | 0796 2640 311 |
| 90 x 3" | MALE THREADED ADAPTOR (MA) 90 x 3" | 0796 2640 312 |
| 110 x 4" | MALE THREADED ADAPTOR (MA) 110 x 4" | 0796 2640 313 |

Female threaded adaptor – FA



| Size mm x inch | Designation | Polypropylene homopolymer Product No. |
|----------------|--|---------------------------------------|
| 16 x 1/2" | FEMALE THREADED ADAPTOR (FA) 16 x 1/2" | 0796 2602 111 |
| 16 x 3/4" | FEMALE THREADED ADAPTOR (FA) 16 x 3/4" | 0796 2602 112 |
| 20 x 1/2" | FEMALE THREADED ADAPTOR (FA) 20 x 1/2" | 0796 2651 018 |
| 20 x 3/4" | FEMALE THREADED ADAPTOR (FA) 20 x 3/4" | 0796 2651 020 |
| 25 x 1/2" | FEMALE THREADED ADAPTOR (FA) 25 x 1/2" | 0796 2651 022 |
| 25 x 3/4" | FEMALE THREADED ADAPTOR (FA) 25 x 3/4" | 0796 2651 025 |
| 25 x 1" | FEMALE THREADED ADAPTOR (FA) 25 x 1" | 0796 2651 028 |
| 32 x 3/4" | FEMALE THREADED ADAPTOR (FA) 32 x 3/4" | 0796 2651 030 |
| 32 x 1" | FEMALE THREADED ADAPTOR (FA) 32 x 1" | 0796 2651 033 |
| 32 x 1 1/4" | FEMALE THREADED ADAPTOR (FA) 32 x 1 1/4" | 0796 2651 035 |
| 40 x 1" | FEMALE THREADED ADAPTOR (FA) 40 x 1" | 0796 2651 037 |
| 40 x 1 1/4" | FEMALE THREADED ADAPTOR (FA) 40 x 1 1/4" | 0796 2651 039 |
| 40 x 1 1/2" | FEMALE THREADED ADAPTOR (FA) 40 x 1 1/2" | 0796 2651 041 |
| 50 x 1 1/2" | FEMALE THREADED ADAPTOR (FA) 50 x 1 1/2" | 0796 2651 043 |
| 50 x 2" | FEMALE THREADED ADAPTOR (FA) 50 x 2" | 0796 2651 045 |
| 63 x 1 1/2" | FEMALE THREADED ADAPTOR (FA) 63 x 1 1/2" | 0796 2651 047 |
| 63 x 2" | FEMALE THREADED ADAPTOR (FA) 63 x 2" | 0796 2651 049 |
| 75 x 2" | FEMALE THREADED ADAPTOR (FA) 75 x 2" | 0796 2640 291 |
| 75 x 2 1/2" | FEMALE THREADED ADAPTOR (FA) 75 x 2 1/2" | 0796 2640 293 |
| 90 x 3" | FEMALE THREADED ADAPTOR (FA) 90 x 3" | 0796 2640 295 |
| 110 x 4" | FEMALE THREADED ADAPTOR (FA) 110 x 4" | 0796 2640 297 |

Male threaded tee – MT



| Size mm x inch | Designation | Polypropylene homopolymer Product No. |
|-------------------|------------------------------------|--|
| 16 x 1/2" | MALE THREADED TEE (MT) 16 x 1/2" | 0796 2603 111 |
| 16 x 3/4" | MALE THREADED TEE (MT) 16 x 3/4" | 0796 2603 112 |
| 20 x 1/2" | MALE THREADED TEE (MT) 20 x 1/2" | 0796 2651 154 |
| 20 x 3/4" | MALE THREADED TEE (MT) 20 x 3/4" | 0796 2651 155 |
| 25 x 1/2" | MALE THREADED TEE (MT) 25 x 1/2" | 0796 2651 156 |
| 25 x 3/4" | MALE THREADED TEE (MT) 25 x 3/4" | 0796 2651 157 |
| 25 x 1" | MALE THREADED TEE (MT) 25 x 1" | 0796 2651 158 |
| 32 x 3/4" | MALE THREADED TEE (MT) 32 x 3/4" | 0796 2651 159 |
| 32 x 1" | MALE THREADED TEE (MT) 32 x 1" | 0796 2651 160 |
| 40 x 1" | MALE THREADED TEE (MT) 40 x 1" | 0796 2651 161 |
| 40 x 1 1/4" | MALE THREADED TEE (MT) 40 x 1 1/4" | 0796 2651 162 |
| 50 x 1 1/4" | MALE THREADED TEE (MT) 50 x 1 1/4" | 0796 2651 163 |
| 50 x 1 1/2" | MALE THREADED TEE (MT) 50 x 1 1/2" | 0796 2651 164 |
| 63 x 2" | MALE THREADED TEE (MT) 63 x 2" | 0796 2651 165 |
| 75 x 2" | MALE THREADED TEE (MT) 75 x 2" | 0796 2640 318 |
| 75 x 2 1/2" | MALE THREADED TEE (MT) 75 x 2 1/2" | 0796 2640 319 |
| 90 x 3" | MALE THREADED TEE (MT) 90 x 3" | 0796 2640 320 |
| 110 x 4" | MALE THREADED TEE (MT) 110 x 4" | 0796 2640 321 |

NORMACONNECT®

Female threaded tee – FT



| Size mm x inch | Designation | Polypropylene homopolymer Product No. |
|-------------------|--------------------------------------|--|
| 16 x 1/2" | FEMALE THREADED TEE (FT) 16 x 1/2" | 0796 2604 111 |
| 16 x 3/4" | FEMALE THREADED TEE (FT) 16 x 3/4" | 0796 2604 112 |
| 20 x 1/2" | FEMALE THREADED TEE (FT) 20 x 1/2" | 0796 2651 088 |
| 20 x 3/4" | FEMALE THREADED TEE (FT) 20 x 3/4" | 0796 2651 090 |
| 25 x 1/2" | FEMALE THREADED TEE (FT) 25 x 1/2" | 0796 2651 092 |
| 25 x 3/4" | FEMALE THREADED TEE (FT) 25 x 3/4" | 0796 2651 094 |
| 25 x 1" | FEMALE THREADED TEE (FT) 25 x 1" | 0796 2651 096 |
| 32 x 3/4" | FEMALE THREADED TEE (FT) 32 x 3/4" | 0796 2651 098 |
| 32 x 1" | FEMALE THREADED TEE (FT) 32 x 1" | 0796 2651 100 |
| 32 x 1 1/4" | FEMALE THREADED TEE (FT) 32 x 1 1/4" | 0796 2651 102 |
| 40 x 1" | FEMALE THREADED TEE (FT) 40 x 1" | 0796 2651 104 |
| 40 x 1 1/4" | FEMALE THREADED TEE (FT) 40 x 1 1/4" | 0796 2651 106 |
| 40 x 1 1/2" | FEMALE THREADED TEE (FT) 40 x 1 1/2" | 0796 2651 108 |
| 50 x 1 1/2" | FEMALE THREADED TEE (FT) 50 x 1 1/2" | 0796 2651 110 |
| 50 x 2" | FEMALE THREADED TEE (FT) 50 x 2" | 0796 2651 112 |
| 63 x 1 1/2" | FEMALE THREADED TEE (FT) 63 x 1 1/2" | 0796 2651 114 |
| 63 x 2" | FEMALE THREADED TEE (FT) 63 x 2" | 0796 2651 116 |
| 75 x 2 1/2" | FEMALE THREADED TEE (FT) 75 x 2 1/2" | 0796 2640 305 |
| 90 x 3" | FEMALE THREADED TEE (FT) 90 x 3" | 0796 2640 307 |
| 110 x 4" | FEMALE THREADED TEE (FT) 110 x 4" | 0796 2640 309 |

COMPRESSION FITTINGS

Male threaded elbow – MB



NORMACONNECT®

| Size mm x inch | Designation | Polypropylene homopolymer Product No. |
|----------------|---|---------------------------------------|
| 16 x 1/2" | MALE THREADED ELBOW (MB) 16 x 1/2" | 0796 2605 111 |
| 16 x 3/4" | MALE THREADED ELBOW (MB) 16 x 3/4" | 0796 2605 112 |
| 20 x 1/2" | MALE THREADED ELBOW - MALE BEND 90 (MB) 20 x 1/2" | 0796 2651 140 |
| 20 x 3/4" | MALE THREADED ELBOW - MALE BEND 90 (MB) 20 x 3/4" | 0796 2651 141 |
| 25 x 1/2" | MALE THREADED ELBOW - MALE BEND 90 (MB) 25 x 1/2" | 0796 2651 142 |
| 25 x 3/4" | MALE THREADED ELBOW - MALE BEND 90 (MB) 25 x 3/4" | 0796 2651 143 |
| 25 x 1" | MALE THREADED ELBOW - MALE BEND 90 (MB) 25 x 1" | 0796 2651 144 |
| 32 x 3/4" | MALE THREADED ELBOW - MALE BEND 90 (MB) 32 x 3/4" | 0796 2651 145 |
| 32 x 1" | MALE THREADED ELBOW - MALE BEND 90 (MB) 32 x 1" | 0796 2651 146 |
| 40 x 1" | MALE THREADED ELBOW - MALE BEND 90 (MB) 40 x 1" | 0796 2651 147 |
| 40 x 1 1/4" | MALE THREADED ELBOW - MALE BEND 90 (MB) 40 x 1 1/4" | 0796 2651 148 |
| 40 x 1 1/2" | MALE THREADED ELBOW - MALE BEND 90 (MB) 40 x 1 1/2" | 0796 2651 149 |
| 50 x 1 1/4" | MALE THREADED ELBOW - MALE BEND 90 (MB) 50 x 1 1/4" | 0796 2651 150 |
| 50 x 1 1/2" | MALE THREADED ELBOW - MALE BEND 90 (MB) 50 x 1 1/2" | 0796 2651 151 |
| 50 x 2" | MALE THREADED ELBOW - MALE BEND 90 (MB) 63 x 2" | 0796 2651 152 |
| 63 x 2" | MALE THREADED ELBOW - MALE BEND 90 (MB) 63 x 2" | 0796 2651 153 |
| 75 x 2" | MALE THREADED ELBOW - MALE BEND 90 (MB) 75 x 2" | 0796 2640 314 |
| 75 x 2 1/2" | MALE THREADED ELBOW - MALE BEND 90 (MB) 75 x 2 1/2" | 0796 2640 315 |
| 90 x 3" | MALE THREADED ELBOW - MALE BEND 90 (MB) 90 x 3" | 0796 2640 316 |
| 110 x 4" | MALE THREADED ELBOW - MALE BEND 90 (MB) 110 x 4" | 0796 2640 317 |

Female threaded elbow – FB



| Size mm x inch | Designation | Polypropylene homopolymer Product No. |
|----------------|---|---------------------------------------|
| 16 x 1/2" | FEMALE THREADED ELBOW (FB) 16 x 1/2" | 0796 2606 111 |
| 16 x 3/4" | FEMALE THREADED ELBOW (FB) 16 x 3/4" | 0796 2606 112 |
| 20 x 1/2" | FEMALE THREADED ELBOW - FEMALE BEND 90 (FB) 20 x 1/2" | 0796 2651 051 |
| 20 x 3/4" | FEMALE THREADED ELBOW - FEMALE BEND 90 (FB) 20 x 3/4" | 0796 2651 054 |
| 25 x 1/2" | FEMALE THREADED ELBOW - FEMALE BEND 90 (FB) 25 x 1/2" | 0796 2651 056 |
| 25 x 3/4" | FEMALE THREADED ELBOW - FEMALE BEND 90 (FB) 25 x 3/4" | 0796 2651 059 |
| 25 x 1" | FEMALE THREADED ELBOW - FEMALE BEND 90 (FB) 25 x 1" | 0796 2651 061 |
| 32 x 1/2" | FEMALE THREADED ELBOW - FEMALE BEND 90 (FB) 32 x 1/2" | 0796 2651 063 |
| 32 x 3/4" | FEMALE THREADED ELBOW - FEMALE BEND 90 (FB) 32 x 3/4" | 0796 2651 065 |
| 32 x 1" | FEMALE THREADED ELBOW - FEMALE BEND 90 (FB) 32 x 1" | 0796 2651 068 |
| 32 x 1 1/4" | FEMALE THREADED ELBOW - FEMALE BEND 90 (FB) 32 x 1 1/4" | 0796 2651 070 |
| 40 x 1" | FEMALE THREADED ELBOW - FEMALE BEND 90 (FB) 40 x 1" | 0796 2651 072 |
| 40 x 1 1/4" | FEMALE THREADED ELBOW - FEMALE BEND 90 (FB) 40 x 1 1/4" | 0796 2651 074 |
| 40 x 1 1/2" | FEMALE THREADED ELBOW - FEMALE BEND 90 (FB) 40 x 1 1/2" | 0796 2651 076 |
| 50 x 1 1/4" | FEMALE THREADED ELBOW - FEMALE BEND 90 (FB) 50 x 1 1/4" | 0796 2651 078 |
| 50 x 1 1/2" | FEMALE THREADED ELBOW - FEMALE BEND 90 (FB) 50 x 1 1/2" | 0796 2651 080 |
| 50 x 2" | FEMALE THREADED ELBOW - FEMALE BEND 90 (FB) 50 x 2" | 0796 2651 082 |
| 63 x 1 1/2" | FEMALE THREADED ELBOW - FEMALE BEND 90 (FB) 63 x 1 1/2" | 0796 2651 084 |
| 63 x 2" | FEMALE THREADED ELBOW - FEMALE BEND 90 (FB) 63 x 2" | 0796 2651 086 |
| 75 x 2 1/2" | FEMALE THREADED ELBOW - FEMALE BEND 90 (FB) 75 x 2 1/2" | 0796 2640 299 |
| 90 x 3" | FEMALE THREADED ELBOW - FEMALE BEND 90 (FB) 90 x 3" | 0796 2640 301 |
| 110 x 4" | FEMALE THREADED ELBOW - FEMALE BEND 90 (FB) 110 x 4" | 0796 2640 303 |

Straight coupler – SC



| Size mm | Designation | Polypropylene homopolymer Product No. |
|---------|---------------------------|---------------------------------------|
| 16 | STRAIGHT COUPLER (SC) 16 | 0796 2607 111 |
| 20 | STRAIGHT COUPLER (SC) 20 | 0796 2651 191 |
| 25 | STRAIGHT COUPLER (SC) 25 | 0796 2651 192 |
| 32 | STRAIGHT COUPLER (SC) 32 | 0796 2651 193 |
| 40 | STRAIGHT COUPLER (SC) 40 | 0796 2651 194 |
| 50 | STRAIGHT COUPLER (SC) 50 | 0796 2651 195 |
| 63 | STRAIGHT COUPLER (SC) 63 | 0796 2651 196 |
| 75 | STRAIGHT COUPLER (SC) 75 | 0796 2640 334 |
| 90 | STRAIGHT COUPLER (SC) 90 | 0796 2640 335 |
| 110 | STRAIGHT COUPLER (SC) 110 | 0796 2640 336 |

Equal bend – EB



| Size mm | Designation | Polypropylene homopolymer Product No. |
|---------|---------------------|---------------------------------------|
| 16 | EQUAL BEND (EB) 16 | 0796 2608 111 |
| 20 | EQUAL BEND (EB) 20 | 0796 2650 998 |
| 25 | EQUAL BEND (EB) 25 | 0796 2650 999 |
| 32 | EQUAL BEND (EB) 32 | 0796 2651 000 |
| 40 | EQUAL BEND (EB) 40 | 0796 2651 001 |
| 50 | EQUAL BEND (EB) 50 | 0796 2651 002 |
| 63 | EQUAL BEND (EB) 63 | 0796 2651 003 |
| 75 | EQUAL BEND (EB) 75 | 0796 2640 281 |
| 90 | EQUAL BEND (EB) 90 | 0796 2640 282 |
| 110 | EQUAL BEND (EB) 110 | 0796 2640 283 |

Equal tee – ET



| Size mm | Designation | Polypropylene homopolymer Product No. |
|---------|--------------------|---------------------------------------|
| 16 | EQUAL TEE (ET) 16 | 0796 2609 111 |
| 20 | EQUAL TEE (ET) 20 | 0796 2651 010 |
| 25 | EQUAL TEE (ET) 25 | 0796 2651 011 |
| 32 | EQUAL TEE (ET) 32 | 0796 2651 012 |
| 40 | EQUAL TEE (ET) 40 | 0796 2651 013 |
| 50 | EQUAL TEE (ET) 50 | 0796 2651 014 |
| 63 | EQUAL TEE (ET) 63 | 0796 2651 015 |
| 75 | EQUAL TEE (ET) 75 | 0796 2640 287 |
| 90 | EQUAL TEE (ET) 90 | 0796 2640 288 |
| 110 | EQUAL TEE (ET) 110 | 0796 2640 289 |

End cap – EC



| Size mm | Designation | Polypropylene homopolymer Product No. |
|---------|------------------|---------------------------------------|
| 16 | END CAP (EC) 16 | 0796 2610 111 |
| 20 | END CAP (EC) 20 | 0796 2651 004 |
| 25 | END CAP (EC) 25 | 0796 2651 005 |
| 32 | END CAP (EC) 32 | 0796 2651 006 |
| 40 | END CAP (EC) 40 | 0796 2651 007 |
| 50 | END CAP (EC) 50 | 0796 2651 008 |
| 63 | END CAP (EC) 63 | 0796 2651 009 |
| 75 | END CAP (EC) 75 | 0796 2640 284 |
| 90 | END CAP (EC) 90 | 0796 2640 285 |
| 110 | END CAP (EC) 110 | 0796 2640 286 |

NORMACONNECT®

COMPRESSION FITTINGS

Reducing coupler – RC



| Size mm x inch | Designation | Polypropylene homopolymer Product No. |
|-------------------|---------------------------------|--|
| 25 x 20" | REDUCING COUPLER (RC) 25 x 20" | 0796 2651 166 |
| 32 x 20" | REDUCING COUPLER (RC) 32 x 20" | 0796 2651 167 |
| 32 x 25" | REDUCING COUPLER (RC) 32 x 25" | 0796 2651 168 |
| 40 x 20" | REDUCING COUPLER (RC) 40 x 20" | 0796 2651 169 |
| 40 x 25" | REDUCING COUPLER (RC) 40 x 25" | 0796 2651 170 |
| 40 x 32" | REDUCING COUPLER (RC) 40 x 32" | 0796 2651 171 |
| 50 x 20" | REDUCING COUPLER (RC) 50 x 20" | 0796 2651 172 |
| 50 x 25" | REDUCING COUPLER (RC) 50 x 25" | 0796 2651 173 |
| 50 x 32" | REDUCING COUPLER (RC) 50 x 32" | 0796 2651 174 |
| 50 x 40" | REDUCING COUPLER (RC) 50 x 40" | 0796 2651 175 |
| 63 x 25" | REDUCING COUPLER (RC) 63 x 25" | 0796 2651 176 |
| 63 x 32" | REDUCING COUPLER (RC) 63 x 32" | 0796 2651 177 |
| 63 x 40" | REDUCING COUPLER (RC) 63 x 40" | 0796 2651 178 |
| 63 x 50" | REDUCING COUPLER (RC) 63 x 50" | 0796 2651 179 |
| 75 x 40" | REDUCING COUPLER (RC) 75 x 40" | 0796 2640 322 |
| 75 x 50" | REDUCING COUPLER (RC) 75 x 50" | 0796 2640 323 |
| 75 x 63" | REDUCING COUPLER (RC) 75 x 63" | 0796 2640 324 |
| 90 x 63" | REDUCING COUPLER (RC) 90 x 63" | 0796 2640 325 |
| 90 x 75" | REDUCING COUPLER (RC) 90 x 75" | 0796 2640 326 |
| 110 x 90" | REDUCING COUPLER (RC) 110 x 90" | 0796 2640 327 |

Reducing tee – RT



| Size mm x inch | Designation | Polypropylene homopolymer Product No. |
|-------------------|-----------------------------|--|
| 25 x 20" | REDUCING TEE (RT) 25 x 20" | 0796 2651 180 |
| 32 x 20" | REDUCING TEE (RT) 32 x 20" | 0796 2651 181 |
| 32 x 25" | REDUCING TEE (RT) 32 x 25" | 0796 2651 182 |
| 40 x 25" | REDUCING TEE (RT) 40 x 25" | 0796 2651 183 |
| 40 x 32" | REDUCING TEE (RT) 40 x 32" | 0796 2651 184 |
| 50 x 25" | REDUCING TEE (RT) 50 x 25" | 0796 2651 185 |
| 50 x 32" | REDUCING TEE (RT) 50 x 32" | 0796 2651 186 |
| 50 x 40" | REDUCING TEE (RT) 50 x 40" | 0796 2651 187 |
| 63 x 32" | REDUCING TEE (RT) 63 x 32" | 0796 2651 188 |
| 63 x 40" | REDUCING TEE (RT) 63 x 40" | 0796 2651 189 |
| 63 x 50" | REDUCING TEE (RT) 63 x 50" | 0796 2651 190 |
| 75 x 40" | REDUCING TEE (RT) 75 x 40" | 0796 2640 328 |
| 75 x 50" | REDUCING TEE (RT) 75 x 50" | 0796 2640 329 |
| 75 x 63" | REDUCING TEE (RT) 75 x 63" | 0796 2640 330 |
| 90 x 63" | REDUCING TEE (RT) 90 x 63" | 0796 2640 331 |
| 90 x 75" | REDUCING TEE (RT) 90 x 75" | 0796 2640 332 |
| 110 x 90" | REDUCING TEE (RT) 110 x 90" | 0796 2640 333 |

Flange adaptor – FLA



| Size mm x mm | Designation | Polypropylene homopolymer Product No. |
|-----------------|----------------------------------|--|
| 63 x 50DN | FLANGE ADAPTOR (FLA) 63 x 50DN | 0796 2600 004 |
| 90 x 80DN | FLANGE ADAPTOR (FLA) 90 x 80DN | 0796 2600 005 |
| 110 x 100DN | FLANGE ADAPTOR (FLA) 110 x 100DN | 0796 2600 006 |

Pop-up Equal bend – PE



| Size mm x inch | Designation | Polypropylene homopolymer Product No. |
|----------------|----------------------------------|---------------------------------------|
| 20 x 1/2" | POP-UP EQUAL BEND (PE) 20 x 1/2" | 0796 2030 181 |
| 25 x 1/2" | POP-UP EQUAL BEND (PE) 25 x 1/2" | 0796 2030 182 |
| 32 x 3/4" | POP-UP EQUAL BEND (PE) 32 x 3/4" | 0796 2030 183 |

Wall plate elbow – WPE



| Size mm x inch | Designation | Polypropylene homopolymer Product No. |
|----------------|----------------------------------|---------------------------------------|
| 25 x 3/4" | WALL PLATE ELBOW (WPE) 25 x 3/4" | 0796 2030 360 |

NORMACONNECT®

Male threaded adaptor with brass insert – MAB



| Size mm x inch | Designation | Polypropylene homopolymer Product No. |
|----------------|---|---------------------------------------|
| 20 x 1/2" | MALE THREADED ADAPTOR WITH BRASS INSERT (MAB) 20 x 1/2" | 0796 2651 119 |
| 25 x 3/4" | MALE THREADED ADAPTOR WITH BRASS INSERT (MAB) 25 x 3/4" | 0796 2651 123 |
| 25 x 1" | MALE THREADED ADAPTOR WITH BRASS INSERT (MAB) 25 x 1" | 0796 2651 125 |
| 32 x 1" | MALE THREADED ADAPTOR WITH BRASS INSERT (MAB) 32 x 1" | 0796 2651 129 |

Female threaded adaptor with brass insert – FAB



| Size mm x inch | Designation | Polypropylene homopolymer Product No. |
|----------------|---|---------------------------------------|
| 20 x 1/2" | FEMALE THREADED ADAPTOR WITH BRASS INSERT (FAB) 20 x 1/2" | 0796 2651 017 |
| 25 x 3/4" | FEMALE THREADED ADAPTOR WITH BRASS INSERT (FAB) 25 x 3/4" | 0796 2651 024 |
| 25 x 1" | FEMALE THREADED ADAPTOR WITH BRASS INSERT (FAB) 25 x 1" | 0796 2651 027 |
| 32 x 1" | FEMALE THREADED ADAPTOR WITH BRASS INSERT (FAB) 32 x 1" | 0796 2651 032 |

Female threaded bend with brass insert – FBB



| Size mm x inch | Designation | Polypropylene homopolymer Product No. |
|----------------|--|---------------------------------------|
| 20 x 3/4" | FEMALE THREADED BEND WITH BRASS INSERT (FBB) 20 x 3/4" | 0796 2651 053 |
| 25 x 3/4" | FEMALE THREADED BEND WITH BRASS INSERT (FBB) 25 x 3/4" | 0796 2651 058 |
| 32 x 1" | FEMALE THREADED BEND WITH BRASS INSERT (FBB) 32 x 1" | 0796 2651 067 |

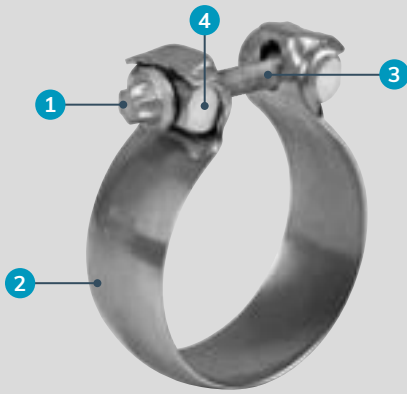

- 1 Torx screw with integrated washer**
- makes installation and removal easier
- 2 Band adapted to fit ball-shaped flange connections**
- system works in perfect harmony
- 3 Free from chromium (VI); easy-slide coating**
- improved clamping force
- 4 Solid trunnion, chromium (VI)-free coating**
- high temperature resistance, maintains high clamping force levels

NORMACONNECT®

Ball-flare connection of exhaust pipes

NORMACONNECT® SEC is the ideal solution when it comes to making connections in central and rear sections of vehicle exhaust systems. When used in conjunction with flange joints, it is possible to swivel exhaust pipes during installation.

Advantages at a glance

- ✔ Allows/compensates for angular deflection of pipe up to $\pm 3^\circ$
- ✔ Exhaust pipes can be swiveled during installation
- ✔ Installation and removal conditions easier to work with thanks to increased flexibility of overall system
- ✔ Low weight and low leakage rate

Applications

For low leak joints in rear and centre sections of car and truck exhaust systems with operating clamp surface temperatures of up to 700 °C.

Materials

| | | | | |
|----|----|----|----|----|
| W1 | W2 | W3 | W4 | W5 |
| | x | | | |

| Material | Corrosion resistance in salt spray testing |
|----------|--|
| W2 | Min. 96 h |

Technical data & Ordering information

| NORMACONNECT® SEC | | | | | |
|-------------------|---------------------|-----------|-------------------------|---------------------|-----------------|
| Designation | Pipe diameter inner | | Clamping diameter in mm | Flange radius in mm | W2 Product No. |
| | in mm | in inches | | | |
| SEC 55 | 55 | 2 3/16" | 65 | 32.5 | 0595 6312 055-1 |
| SEC 60 | 60 | 2 3/8" | 69.5 | 34.8 | 0595 5312 060-1 |
| SEC 65 | 65 | 2 9/16" | 75 | 37.6 | 0595 5312 065-1 |
| SEC 70 | 70 | 2 3/4" | 81.5 | 40.2 | 0595 6312 070-1 |
| SEC 75 | 75 | 2 20/21" | 87 | 42.5 | 0595 6342 075 |

Additional diameters on request

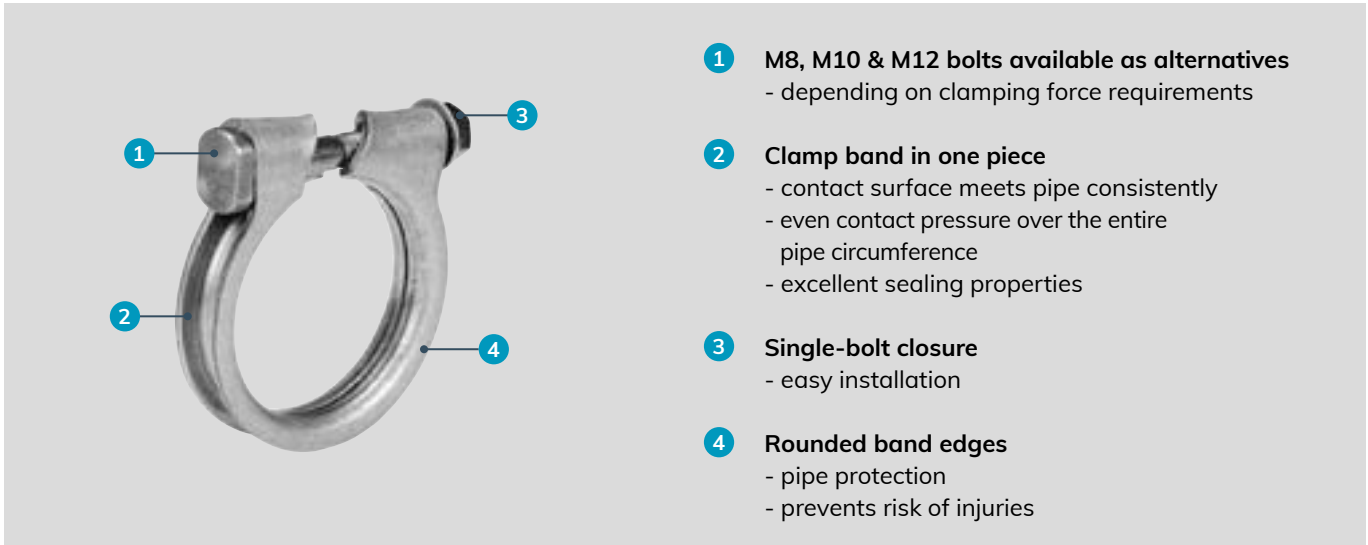

- 1 M8, M10 & M12 bolts available as alternatives
- depending on clamping force requirements
- 2 Clamp band in one piece
- contact surface meets pipe consistently
- even contact pressure over the entire pipe circumference
- excellent sealing properties
- 3 Single-bolt closure
- easy installation
- 4 Rounded band edges
- pipe protection
- prevents risk of injuries

Exhaust pipe clamps

NORMACONNECT® ARS exhaust pipe clamps provide a secure, reliable connection for pipes that are fitted into one another, even those that are subject to significant temperature fluctuations. As such, they are particularly suitable for connecting exhaust pipes and silencers in the automotive industry.

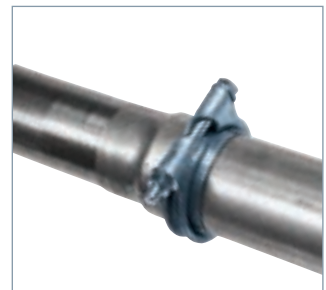

Advantages at a glance

- ✓ One piece
- ✓ Contact surface meets pipe consistently
- ✓ Even contact pressure over entire pipe circumference
- ✓ No risk of asymmetrical pipe deformation

Applications

- Agricultural machines
- Building machines
- Engine manufacturing

Materials

| W1 | W2 | W3 | W4 | W5 |
|----|----|----|----|----|
| x | x* | | x* | x* |

* On request.

| Material | Corrosion resistance in salt spray testing |
|----------|--|
| W1 | Min. 144 h |

Bolts

| Bolt | Hammer head bolt/Flange nut | Hexagon-head bolt/Flange nut | Hexagon-head bolt/Hexagon | Loose washer * |
|------|-----------------------------|------------------------------|---------------------------|----------------|
| M8 | x | x | | x** |
| M10 | | | x | x |
| M12 | | | x | x |

* Under bolt head and under bolt nut.
** Under bolt head (select nominal diameters only).

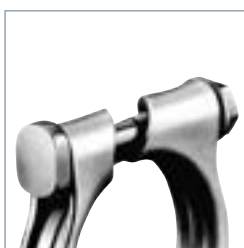

M8 version with hammer head bolt.

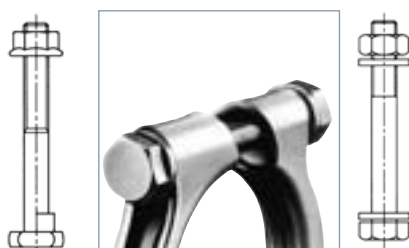

M10 and M12 version with hexagon-head bolt.

Technical data & Ordering information

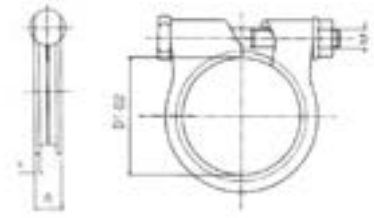

NORMACONNECT®

| NORMACONNECT® ARS | | | | | |
|-------------------|--------------------------------|-----|------|----------------------------------|-------------------|
| Designation | Clamping ranges D1-D2 in mm | S | B | Recommended tightening torque | W1 Product No. |
| ARS-M8-27 | 24-27 | 1.5 | 10.4 | 8 – 10 Nm | 0151 8939 027 |
| ARS-M8-33 | 30-33 | 1.5 | 10.4 | | 0151 8939 033 |
| ARS-M8-36 | 33-36 | 2.0 | 12.8 | 10 – 15 Nm | 0151 8940 036 |
| ARS-M8-39.5 | 36.5-39.5 | 2.0 | 12.0 | | 0151 8940 040 |
| ARS-M8-42 | 39-42 | 2.0 | 12.8 | | 0151 8940 042 |
| ARS-M8-45 | 42-45 | 2.5 | 13.6 | 15 – 20 Nm | 0151 8941 045 |
| ARS M8-46 | 43-46 | 2.5 | 12.8 | | 0151 8941 046 |
| ARS-M8-47 | 44-47 | 2.5 | 13.6 | | 0151 8941 047 |
| ARS-M8-48 | 45-49 | 2.5 | 13.2 | | 0151 8941 048 |
| ARS-M8-49 | 45-49 | 2.5 | 13.2 | | 0151 8941 049 |
| ARS-M8-50.5 | 51-54 | 2.5 | 13.2 | | 0151 8941 505 |
| ARS-M8-51 | 48-51 | 2.5 | 13.2 | | 0151 8941 051 |
| ARS-M8-54 | 51-54 | 2.5 | 13.2 | | 0151 8941 054 |
| ARS-M8-55 | 52-55 | 2.5 | 13.6 | | 0151 8941 055 |
| ARS-M8-58 | 55-58 | 2.5 | 13.2 | | 0151 8941 058 |
| ARS-M8-64 | 61-64 | 2.5 | 13.2 | | 0151 8941 064 |
| ARS-M8-66 | 63-66 | 2.5 | 13.2 | | 0151 8941 066 |
| ARS-M8-71 | 68-71 | 2.5 | 13.2 | | 0151 8941 071 |

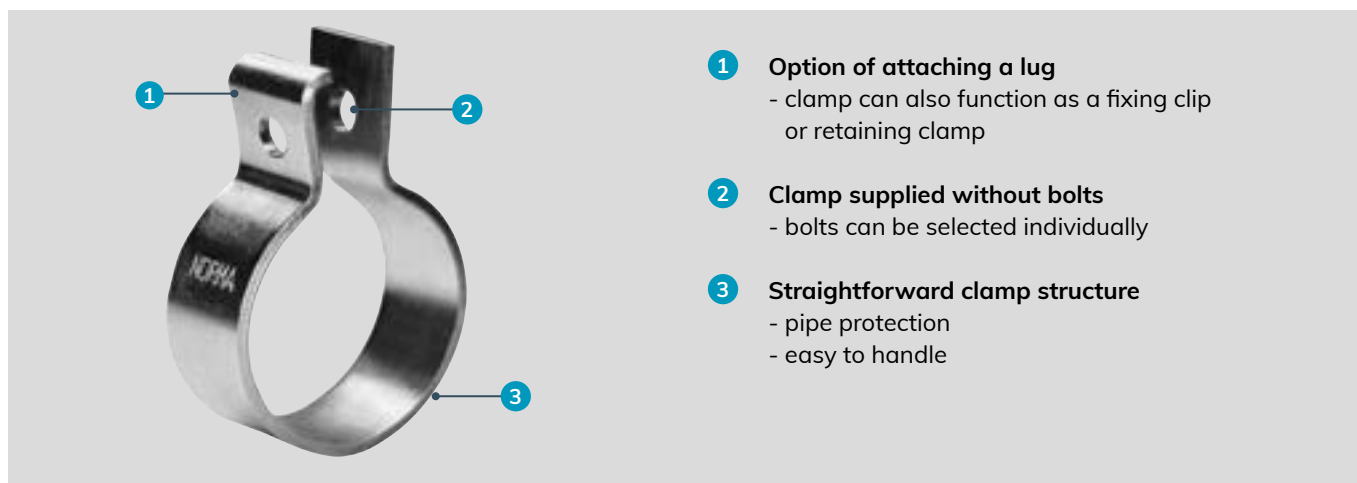

- 1 Option of attaching a lug**
- clamp can also function as a fixing clip or retaining clamp
- 2 Clamp supplied without bolts**
- bolts can be selected individually
- 3 Straightforward clamp structure**
- pipe protection
- easy to handle

Exhaust pipe clamps in accordance with DIN 71555

NORMACONNECT® RS/DIN exhaust pipe clamps are an alternative to NORMACONNECT® ARS clamps. They ensure an equally secure connection for pipes that are fitted into one another. Additionally, the straight-forward clamp structure of the RS/DIN version allows a lug to be attached to it, meaning that it can also be used as a fixing clip.



Advantages at a glance

- ✓ Safe system for connecting pipes that are fitted to one another
- ✓ Can also be used as a fixing clip or retaining clamp
- ✓ In accordance with DIN 71555

Applications

- Agricultural machines
- Building machines
- Engine manufacturing

Materials

| W1 | W2 | W3 | W4 | W5 |
|----|----|----|----|----|
| x | | x* | x* | x* |

* On request.

| Material | Corrosion resistance in salt spray testing |
|----------|--|
| W1 | Min. 144 h |

Bolts

The scope of delivery does not include fastening bolts or nuts. Sizes M8 or M10 are required.

Technical data & Ordering information

| NORMACONNECT® RS/DIN | | | |
|----------------------|--------------------|-------------------------|----------------|
| Band width | Designation | Clamping diameter in mm | W1 Product No. |
| 20 | RS 30.2 DIN 71555 | 30.2 | 0550 7000 030 |
| | RS 32.2 DIN 71555 | 32.2 | 0550 7000 032 |
| | RS 35.2 DIN 71555 | 35.2 | 0550 7000 035 |
| | RS 37.2 DIN 71555 | 37.2 | 0550 7000 037 |
| 25 | RS 40.3 DIN 71555 | 40.3 | 0550 7000 040 |
| | RS 42.3 DIN 71555 | 42.3 | 0550 7000 042 |
| | RS 45.5 DIN 71555 | 45.5 | 0550 7000 045 |
| | RS 48.5 DIN 71555 | 48.5 | 0550 7000 048 |
| | RS 50.5 DIN 71555 | 50.5 | 0550 7000 050 |
| | RS 53.5 DIN 71555 | 53.5 | 0550 7000 053 |
| | RS 55.5 DIN 71555 | 55.5 | 0550 7000 055 |
| | RS 58.5 DIN 71555 | 58.5 | 0550 7000 058 |
| | RS 60.5 DIN 71555 | 60.5 | 0550 7000 060 |
| | RS 63.5 DIN 71555 | 63.5 | 0550 7000 063 |
| | RS 65.5 DIN 71555 | 65.5 | 0550 7000 065 |
| | RS 68.5 DIN 71555 | 68.5 | 0550 7000 068 |
| 30 | RS 70.5 DIN 71555 | 70.5 | 0550 7000 070 |
| | RS 73.5 DIN 71555 | 73.5 | 0550 7000 073 |
| | RS 75.5 DIN 71555 | 75.5 | 0550 7000 075 |
| | RS 78.5 DIN 71555 | 78.5 | 0550 7000 078 |
| | RS 85.5 DIN 71555 | 85.5 | 0550 7000 085 |
| | RS 89.5 DIN 71555 | 89.5 | 0550 7000 089 |
| | RS 90.5 DIN 71555 | 90.5 | 0550 7000 090 |
| | RS 94.5 DIN 71555 | 94.5 | 0550 7000 094 |
| | RS 100.5 DIN 71555 | 100.5 | 0550 7000 100 |
| | RS 104.5 DIN 71555 | 104.5 | 0550 7000 104 |
| | RS 110.5 DIN 71555 | 110.5 | 0550 7000 110 |



- 1 High-strength fastener hardware
- 2 Easy to assemble
- 3 Reaction block serves as a defined stop, avoiding pipe deformation

NORMACONNECT®

High-performance clamp for joining two overlapping exhaust pipes

The NORMACONNECT® AccuSeal offers an innovative reaction block technology to provide a full 360 degree equal distribution of clamping force, prohibiting pipe distortion while completing a unique seal around the joined exhaust components with high clamp load.



Advantages at a glance

- ✓ Durable installation without damaging the pipe ends
- ✓ 360° equal distribution of clamping force
- ✓ Exhaust connections are serviceable and easy to disassemble
- ✓ Clamp available in different materials to cover a broad range of exhaust pipes
- ✓ Low weight and low leakage rate

Applications

AccuSeal clamps are used to join two overlapping exhaust pipes in rear and center sections of passenger and commercial vehicles. Recommended for pipes with wall thickness between 1.2 and 1.6 mm.

Materials

| W1 | W2 | W3 | W4 | W5 |
|----|----|----|----|----|
| x | | x | x | |

Technical data & Ordering information

- Assembly torque: 55 +/- 8 Nm
- Maximum pipe surface temperature: 600 °C

| NORMACONNECT® ACCUSEAL | | | | |
|------------------------|--|----------------|----------------|----------------|
| Designation | Clamp diameter in delivery condition in mm | W1 Product No. | W3 Product No. | W4 Product No. |
| AccuSeal 476 | 47.6 | | 0366 6100 476 | |
| AccuSeal 506 | 50.6 | | 0366 6100 506 | 0366 6120 506 |
| AccuSeal 520 | 52.0 | | 0366 6100 520 | |
| AccuSeal 549 | 54.9 | | 0366 6100 549 | |
| AccuSeal 556 | 55.6 | | | 0366 6120 556 |
| AccuSeal 564 | 56.4 | 0366 6100 564 | 0366 6110 564 | |
| AccuSeal 606 | 60.6 | | 0366 6110 606 | 0366 6120 606 |
| AccuSeal 626 | 62.6 | | | 0366 6110 626 |
| AccuSeal 629 | 62.9 | 0366 6100 629 | 0366 6120 629 | |
| AccuSeal 649 | 64.9 | | 0366 6110 649 | |
| AccuSeal 656 | 65.6 | 0366 6100 656 | 0366 6110 656 | 0366 6120 656 |
| AccuSeal 689 | 68.9 | 0366 6100 689 | | |
| AccuSeal 691 | 69.1 | | 0366 6100 691 | |
| AccuSeal 706 | 70.6 | 0366 6110 706 | 0366 6120 706 | 0366 6130 706 |
| AccuSeal 756 | 75.6 | | 0366 6000 756 | 0366 6100 756 |
| AccuSeal 816 | 81.6 | | | 0366 6100 816 |
| AccuSeal 818 | 81.8 | | 0366 6120 818 | |
| AccuSeal 949 | 94.9 | 0366 6100 949 | 0366 6110 949 | |
| AccuSeal 1072 | 107.2 | 0366 6121 072 | 0366 6111 072 | |
| AccuSeal 1326 | 132.6 | | 0366 6101 326 | |
| AccuSeal 1327 | 132.7 | | | 0366 6001 327 |
| AccuSeal 1582 | 158.2 | 0366 6101 582 | 0366 6111 582 | |

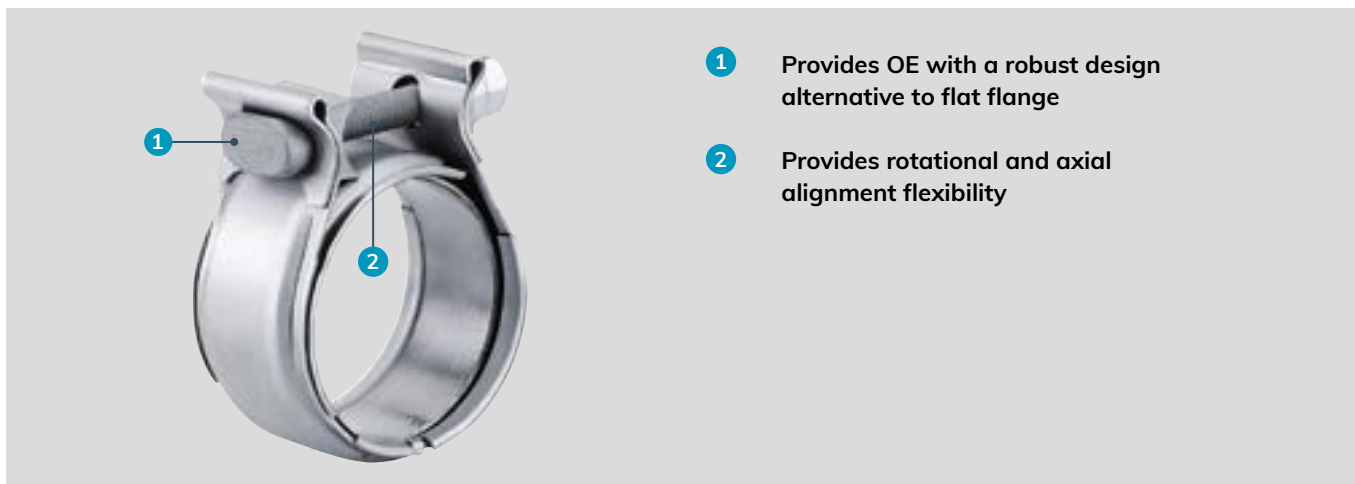

- 1 Provides OE with a robust design alternative to flat flange
- 2 Provides rotational and axial alignment flexibility

Robust alternative clamp

The NORMACONNECT® AccuLock exhaust clamp provides a robust alternative to flat flanges with enhanced assembly flexibility, lower weight and improved overall value. Designed for use in low leak, pre- and after-treatment (catalyst) applications. Uses less space than a flat flange joint and has positive axial retention.

Advantages at a glance

- ✓ Enhanced assembly flexibility, lower weight, improved overall value
- ✓ Positive axial retention
- ✓ Uses less space than a flat flange joint

Applications

Designed for use in low leak, pre- and after-treatment (catalyst) applications

Materials

- Aluminized steel
- 409 stainless steel
- 430 stainless steel

Information

Available in standard industry sizes from 55 mm (2 1/5") up to 387.6 mm (15 1/3")

Technical data & Ordering information

| NORMACONNECT® ACCULOCK | | | |
|------------------------|-----------|-----------|------------------------------|
| Designation | Diameters | | Aluminized Steel Product No. |
| | in mm | in inches | |
| ACCULOCK 55 | 55 | 2 1/5" | 0370 0000 055 |
| ACCULOCK 63.5 | 63.5 | 2 1/2" | 0370 0001 064 |
| ACCULOCK 88.9 | 88.9 | 3 1/2" | 0370 0002 089 |

NORMACONNECT®

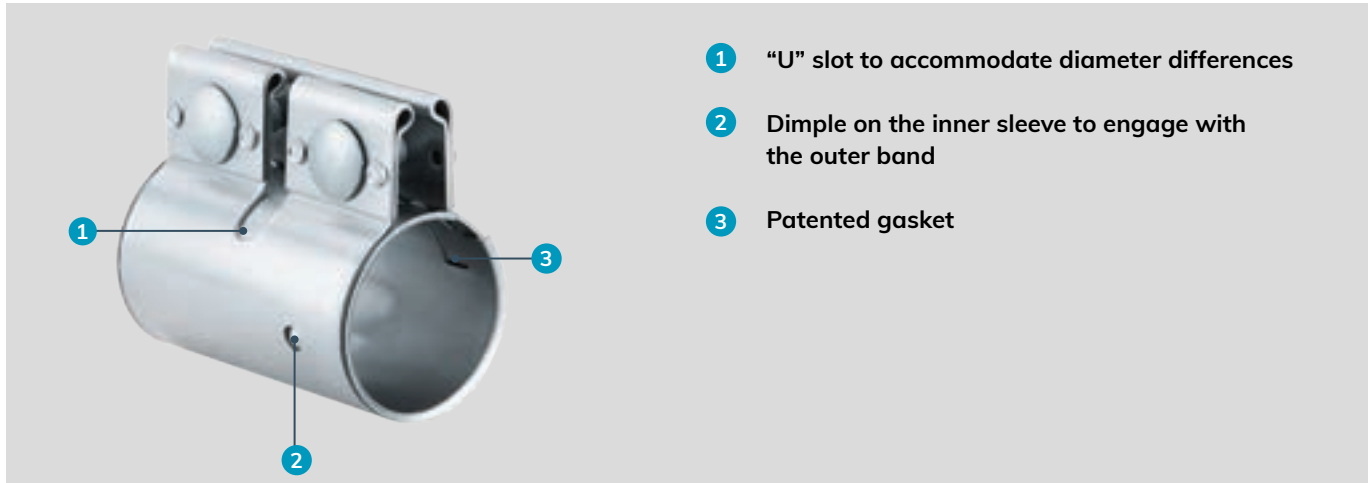

- 1 "U" slot to accommodate diameter differences
- 2 Dimple on the inner sleeve to engage with the outer band
- 3 Patented gasket

Joining exhaust system components

The NORMACONNECT® EuroCoupler is an effective way to join exhaust system components without the need for pipe flares/slip joints or slotting. This clamp offers superior clamp load capability and a serviceable joint. Allows for quick assembly and service of exhaust pipes. It provides significant resistance to longitudinal and rotational movement of pipes.

Advantages at a glance

- ✓ No need for pipe sizing or slotting
- ✓ Patented gasket with proven sealing ability to reduce leak rates
- ✓ Preassembled unit – easy, reliable installation
- ✓ Superior clamp load capability

Applications

Effective way to join pipe to pipe connections of same diameter in an exhaust system.

Materials

| | | | | |
|----|----|----|----|----|
| W1 | W2 | W3 | W4 | W5 |
| | | x | | |

Technical data & Ordering information

| NORMACONNECT® EUROCOUPLER | | | |
|---------------------------|-----------------------|------------------|-------------------|
| Width in mm | Designation | Nominal diameter | W3 Product No. |
| | | in mm | |
| 88.7 | EUROCOUPLER 40-441/88 | 40 | 0367 6005 040 |
| | EUROCOUPLER 45-441/88 | 45 | 0367 6009 045 |
| | EUROCOUPLER 50-441/88 | 50 | 0367 6010 050 |
| | EUROCOUPLER 55-441/88 | 55 | 0367 6008 055 |
| | EUROCOUPLER 60-441/88 | 60 | 0367 6011 060 |
| | EUROCOUPLER 65-441/88 | 65 | 0367 6022 065 |
| | EUROCOUPLER 70-441/88 | 70 | 0367 6033 070 |



1 Pre-mounted screw and nuts

Exhaust system pipe clamp

The NORMACONNECT® Pipe Clamp M8/M10 meets quality standards, which are suitable for use with a wide range of pipe diameters. Pipe clamps are not only used in exhaust systems.

Advantages at a glance

- ✓ Hexagonal wheel for better maintenance of the U
- ✓ Completely assembled
- ✓ Suitable for use with a wide range of pipe diameters

Applications

- Exhaust systems
- Mounting of signage
- TV antennas/aerials

Materials

| W1 | W2 | W3 | W4 | W5 |
|----|----|----|----|----|
| x | | | x | |

Technical data & Ordering information

| NORMACONNECT® PIPE CLAMP M8/M10 | | | |
|---------------------------------|----------------|----------------|----------------|
| Designation | Diameter in mm | W1 Product No. | W4 Product No. |
| PIPE CLAMP M8 32 | 32 | 08937481032 | 08937411032 |
| PIPE CLAMP M8 35 | 35 | 08937481035 | 08937411035 |
| PIPE CLAMP M8 38 | 38 | 08937481038 | 08937411038 |
| PIPE CLAMP M8 40 | 40 | 08937481040 | 08937411040 |
| PIPE CLAMP M8 42 | 42 | 08937481042 | 08937411042 |
| PIPE CLAMP M8 44 | 44 | 08937481044 | 08937411044 |
| PIPE CLAMP M8 45 | 45 | 08937481045 | 08937411045 |
| PIPE CLAMP M8 48 | 48 | 08937481048 | 08937411048 |
| PIPE CLAMP M8 52 | 52 | 08937481052 | 08937411052 |
| PIPE CLAMP M8 54 | 54 | 08937481054 | 08937411054 |
| PIPE CLAMP M8 57 | 57 | 08937481057 | 08937411057 |
| PIPE CLAMP M8 60 | 60 | 08937481060 | 08937411060 |
| PIPE CLAMP M8 65 | 65 | 08937481065 | 08937411065 |
| PIPE CLAMP M8 70 | 70 | 08937481070 | 08937411070 |
| PIPE CLAMP M8 76 | 76 | 08937481076 | 08937411076 |
| PIPE CLAMP M10 90 | 90 | 08937481090 | |
| PIPE CLAMP M10 115 | 115 | 08937481115 | |
| PIPE CLAMP M10 127 | 127 | 08937481127 | |
| PIPE CLAMP M10 140 | 140 | 08937481140 | |

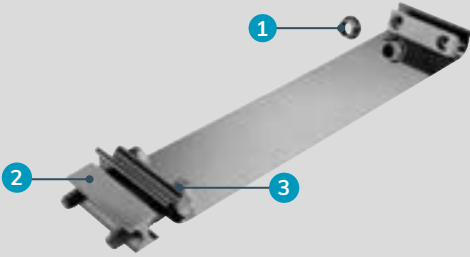

- 1 High-strength, plated grade 8 fasteners
- 2 The original invented reaction block technology creates a complete “inner circle seal” when clamp is secured
- 3 Pre-attached hardware for fast, easy and accurate installation

NORMACONNECT®

Wide band exhaust clamps

The NORMACONNECT® EasySeal offers the best value in wideband exhaust clamps. Used for joining overlapping exhaust members. The unique design makes for fast, easy and accurate installation.

Advantages at a glance

- ✓ Unique design makes for fast, easy and accurate installation – there’s no need to separate pipes or exhaust members before clamping
- ✓ Replaces U-bolts and clamps
- ✓ With pre-attached hardware
- ✓ Ideal, service specific design
- ✓ Flat, packaged, easy to store
- ✓ Easy, fast, accurate installation
- ✓ Unique sealing performance
Durable installation without damage to pipe ends

Materials

304 Stainless steel

Applications

To connect exhaust system components

Information

Available in standard industry sizes from 50.8 mm (2") up to 203.2 mm (8")

Technical data & Ordering information

| NORMACONNECT® EASYSEAL | | | |
|------------------------|-----------|-----------|---------------------------------|
| Designation | Diameters | | 304 Stainless Steel Product No. |
| | in mm | in inches | |
| EASYSEAL 50.8 | 50.8 | 2" | 0368 6000 051 |
| EASYSEAL 57.15 | 57.15 | 2 1/4" | 0368 6000 056 |
| EASYSEAL 63.5 | 63.5 | 2 1/2" | 0368 6000 064 |
| EASYSEAL 69.85 | 69.85 | 2 3/4" | 0368 6000 069 |
| EASYSEAL 76.2 | 76.2 | 3" | 0368 6000 076 |
| EASYSEAL 88.9 | 88.9 | 3 1/2" | 0368 6000 089 |
| EASYSEAL 101.6 | 101.6 | 4" | 0368 6000 102 |
| EASYSEAL 114.3 | 114.3 | 5" | 0368 6000 114 |
| EASYSEAL 127 | 127 | 5" | 0368 6000 127 |
| EASYSEAL 152.4 | 152.4 | 6" | 0368 6000 152 |
| EASYSEAL 177.8 | 177.8 | 7" | 0368 6000 178 |
| EASYSEAL 203.2 | 203.2 | 8" | 0368 6000 203 |

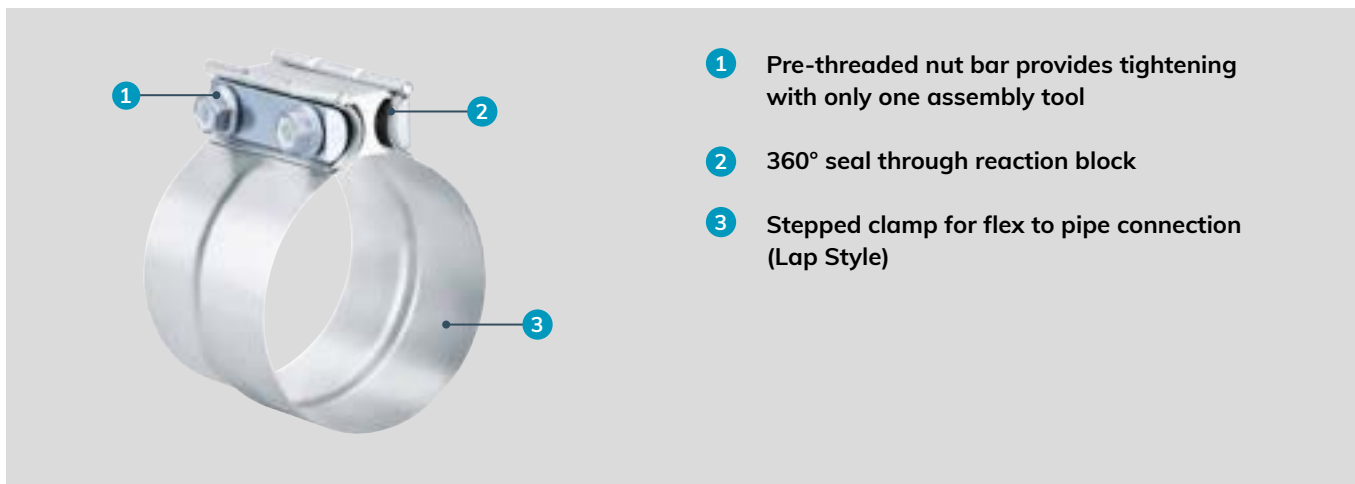

- 1 Pre-threaded nut bar provides tightening with only one assembly tool
- 2 360° seal through reaction block
- 3 Stepped clamp for flex to pipe connection (Lap Style)

Flexible wide band exhaust clamp

The NORMACONNECT® TorcTite stands out thanks to its durable clamping performance and superior clamp load capacities for pipes, flex and mufflers. It is available in two versions: with lap style joint for connecting pipes with different diameters or to connect flex to pipe. And with butt style joint to connect pipes with the same diameter.

Advantages at a glance

- ✓ Pre-threaded nut bar provides tightening with only one assembly tool
- ✓ Can be used to connect pipes with different diameters
- ✓ Compatible with pipes, flex and mufflers
- ✓ 360° seal through reaction block
- ✓ Durable installation without damage to pipe ends (puckering)

Applications

Flex to pipe and pipe to pipe connections in exhaust systems

Materials

- 304SS band
- Aluminum Reaction block
- Carbon steel zinc plated bolt

Technical data & Ordering information

| NORMACONNECT® TORCTITE - Lap Style Joint | | | |
|--|-----------|-----------|---------------|
| Designation | Diameters | | Product No. |
| | in mm | in inches | |
| TORCTITE LS 50.8 | 50.8 | 2" | 0368 6112 051 |
| TORCTITE LS 52.7 | 57.2 | 2 1/4" | 0368 6103 057 |
| TORCTITE LS 63.5 | 63.5 | 2 1/2" | 0368 6111 064 |
| TORCTITE LS 69.9 | 69.9 | 2 3/4" | 0368 6105 070 |
| TORCTITE LS 76.2 | 76.2 | 3" | 0368 6110 076 |
| TORCTITE LS 88.9 | 88.9 | 3 1/2" | 0368 6113 089 |
| TORCTITE LS 101.6 | 101.6 | 4" | 0368 6125 102 |
| TORCTITE LS 114.3 | 114.3 | 4 1/2" | 0368 6110 114 |
| TORCTITE LS 127 | 127 | 5" | 0368 8125 127 |
| TORCTITE LS 152.4 | 152.4 | 6" | 0368 6120 152 |

| NORMACONNECT® TORCTITE - Butt Style Joint | | | |
|---|-----------|-----------|---------------|
| Designation | Diameters | | Product No. |
| | in mm | in inches | |
| TORCTITE BS 50.8 | 50.8 | 2" | 0368 0300 051 |
| TORCTITE BS 52.7 | 57.2 | 2 1/4" | 0368 0300 057 |
| TORCTITE BS 63.5 | 63.5 | 2 1/2" | 0368 0302 064 |
| TORCTITE BS 69.9 | 69.9 | 2 3/4" | 0368 0302 070 |
| TORCTITE BS 76.2 | 76.2 | 3" | 0368 0301 076 |
| TORCTITE BS 88.9 | 88.9 | 3 1/2" | 0368 0302 089 |
| TORCTITE BS 101.6 | 101.6 | 4" | 0368 0303 102 |
| TORCTITE BS 114.3 | 114.3 | 4 1/2" | 0368 0304 114 |
| TORCTITE BS 127 | 127 | 5" | 0368 0304 127 |
| TORCTITE BS 152.4 | 152.4 | 6" | 0368 0304 152 |

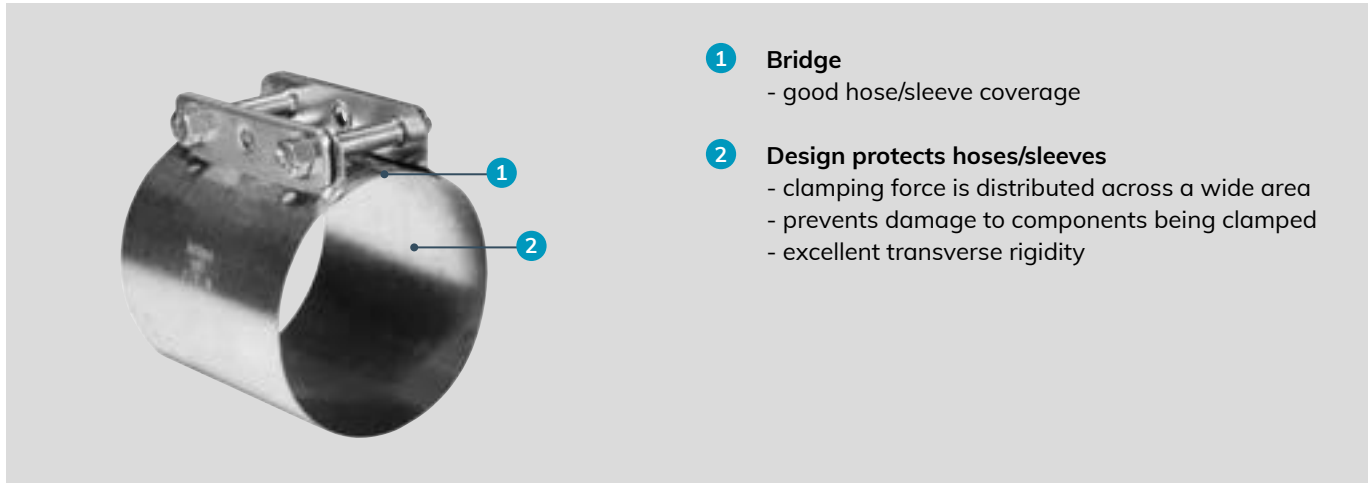

- 1 Bridge**
- good hose/sleeve coverage
- 2 Design protects hoses/sleeves**
- clamping force is distributed across a wide area
- prevents damage to components being clamped
- excellent transverse rigidity

Wide-band hose clamps in accordance with DIN 3017-5

Used in conjunction with a rubber sleeve, NORMACONNECT® BRS wide-band hose clamps are the ideal choice for connecting pipes with smooth ends. They connect cast iron and steel pipes just as securely as plastic or glass pipes and without any welding.

NORMACONNECT® wide-band hose and retaining clamps are produced with standardized band widths and materials. The progressive ratio is 1 mm in the case of a single-part version. Up to a clamping diameter of 300 mm, the clamps are supplied in rolled-up form. With clamping diameters of 301 mm and upwards, they are supplied in stretched-out form.

Advantages at a glance

- ✓ Extremely wide band
- ✓ Clamping force distributed over a large area
- ✓ High level of transverse rigidity
- ✓ Single-part and multi-part versions

Applications

- Machine building
- White goods
- Food and beverage industry
- Agricultural machines
- Engine manufacturing
- Exhaust air technology
- Suction systems
- Laboratory technology
- Drainage technology

Materials

| | | | | |
|----|----|----|----|----|
| W1 | W2 | W3 | W4 | W5 |
| | x | | x | |

| Material | Corrosion resistance in salt spray testing |
|----------|--|
| W2 | Min. 72 h |
| W4 | Min. 240 h |

Bolts

| NORMACONNECT® BRS | | |
|-------------------|----------------------|----------------------|
| Band width | Sz in the case of W2 | Sk in the case of W4 |
| 48 | M6 x 38 Sz | M6 x 45 Sk |
| 54 | M8 x 47 Sz | M8 x 50 Sk |
| 65 | M8 x 47 Sz | M8 x 50 Sk |

Technical data

| NORMACONNECT® BRS | | | | |
|-------------------|------------------------|--------------------------------|--------------------------|-----|
| Band width in mm | Minimum diameter in mm | Static tightening torque in Nm | Material thickness in mm | |
| | | | W2 | W4 |
| 48 | 50 | 4 | 0.4 | 0.5 |
| 54 | 50 | 12 | 0.4 | 0.5 |
| 65 | 50 | 12 | 0.4 | 0.5 |

Ordering information

| | 1. Type | 2. Clamping range | 3. Band width | 4. Material | 5. Bolt |
|---------|---------|-------------------|---------------|-------------|---------|
| Example | BRS | 55 | 48 | W2 | Sz |

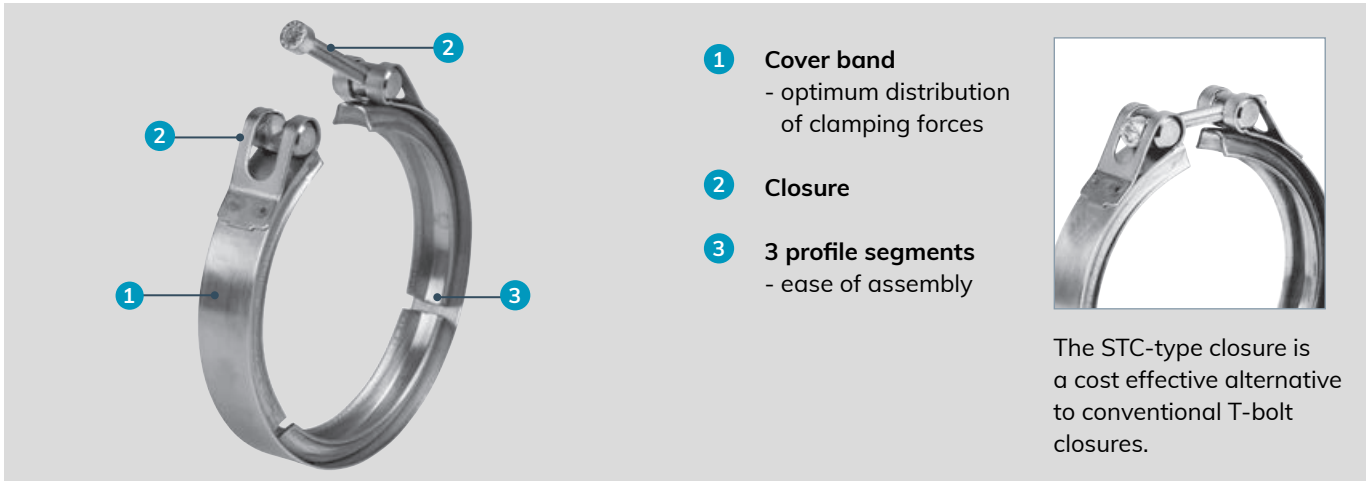

- 1 **Cover band**
- optimum distribution of clamping forces
- 2 **Closure**
- 3 **3 profile segments**
- ease of assembly

The STC-type closure is a cost effective alternative to conventional T-bolt closures.

Profile clamp with cover band

The NORMACONNECT® V Profile Clamps are reliable and time-effective connection elements for industrial and automotive use. They are made to customer requirements and can be supplied with various profiles, band widths and closure types.

Advantages at a glance

- ✓ Low friction losses
- ✓ Robust precision components
- ✓ High corrosion resistance
- ✓ State-of-the-art automated manufacturing
- ✓ Highly competitively priced

Materials

| Code | Closures | | Closure components | Profile segments/ Cover band |
|------|----------|-----|--------------------|------------------------------|
| | STC | QRC | | |
| W4 | • | • | Stainless steel | Stainless steel |

| ISO | DIN | AISI | BS | AFNOR |
|---------------|--------|------|----------|-------------|
| X5 CrNi 18-10 | 1.4301 | 304 | 304 S 15 | Z6 CN 18-09 |

Applications

- Automotive: Turbocharger – catalytic converter connection
- Automotive: Diesel particulate filter
- Industry: Bulk material container
- Industry: Bypass filter unit

Product's method of operation

The profile clamp's method of operation is based on the principle of an inclined plane. When the closure bolt is tightened, this exerts circumferential force on the profile segments. The two halves of the flange are pressed together by means of the profile (see diagram below). The circumferential force that is exerted is converted into considerably higher axial force.

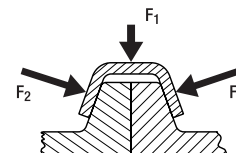

All profiles at a glance

- Single-part 3 profile segments
- Available up to diameter 300 mm
- Two-part 2 profile segments
- Available from diameter 200 mm up to 500 mm

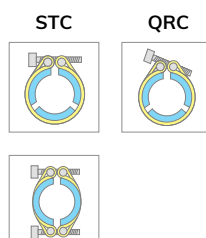

Example of flange designs

Use of gasket may be required in some applications. Support and advice on gasket selection can be provided.

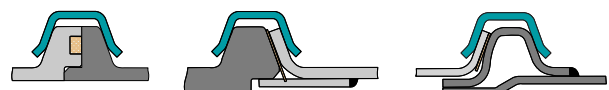

Profile types

NORMA CONNECT®

| 4.0 b | | ≥ ø 89 | | 5.0 a | | ≥ ø 82 | | 5.3 b | | ≥ ø 108 | | 6.0 a | | ≥ ø 82 | |
|-------|-------|--------|-----|-------|-------|---------|-------|--------|-----|---------|-------|--------|-------|---------|--|
| | | | | | | | | | | | | | | | |
| | 20 mm | 25 mm | | 20 mm | 25 mm | | 20 mm | 25 mm | | 20 mm | 25 mm | | 20 mm | 25 mm | |
| STC | ● | | STC | ● | | STC | ● | | STC | ● | | STC | ● | | |
| QRC | ● | | QRC | ● | | QRC | ● | | QRC | ● | | QRC | ● | | |
| 6.6 b | | ≥ ø 90 | | 9.2 a | | ≥ ø 100 | | 10.2 a | | ≥ ø 98 | | 14.5 a | | ≥ ø 100 | |
| | | | | | | | | | | | | | | | |
| | 20 mm | 25 mm | | 20 mm | 25 mm | | 20 mm | 25 mm | | 20 mm | 25 mm | | 20 mm | 25 mm | |
| STC | ● | | STC | | ● | STC | | ● | STC | | ● | STC | | ● | |
| QRC | ● | | QRC | | ● | QRC | | ● | QRC | | ● | QRC | | ● | |

The inner profile diameter can be freely selected in millimeter increments. All profiles can be supplied with a diameter of up to ø 500 mm. Please refer to the relevant profile diagram in the table below to find out the minimum diameter permissible for that profile.

Profile clamps can be supplied with cover bands measuring 20 mm or 25 mm in width.

The table above indicates which cover band is suitable for which profile.

Examples of flange structures

| Inner profile ø | | Flange 1 | | Flange 2 | | | | Flange 3 | | | | Flange 4 | | | |
|--|----------------|----------|--------|----------|--------|--------|--------|-----------------|--------|--------|--------|-----------------|--------|--------|--------|
| | | | | | | | | | | | | | | | |
| Profile type | Profile ø (mm) | W (mm) | H (mm) | W (mm) | H (mm) | R (mm) | T (mm) | W (mm) | H (mm) | R (mm) | T (mm) | W (mm) | H (mm) | R (mm) | T (mm) |
| 4.0b | ≥ 89 | 5.1 | 7.5 | 5.1 | 8 | 2 | 2 | 5.1 | 7.5 | 1 | 1 | Not recommended | | | |
| 5.0a | ≥ 82 | 6.1 | 4.6 | 6.1 | 4.6 | 1.5 | 1.5 | 6.1 | 4.6 | 1 | 1 | 6.1 | 4.6 | 1.5 | 1.5 |
| 5.3b | ≥ 108 | 6.4 | 7.3 | 6.4 | 7.8 | 2 | 2 | 6.4 | 7.3 | 1.5 | 1.5 | 6.4 | 7.8 | 2 | 2 |
| 6.0a | ≥ 82 | 7.1 | 4 | 7.1 | 4 | 1.5 | 1.5 | Not recommended | | | | 7.1 | 4 | 1.5 | 1.5 |
| 6.6b | ≥ 90 | 7.7 | 6.6 | 7.7 | 6.6 | 1.5 | 1.5 | 7.7 | 6.6 | 1.5 | 1.5 | 7.7 | 6.6 | 1.5 | 1.5 |
| 9.2a | ≥ 100 | 10.3 | 7.3 | 10.3 | 7.8 | 2 | 2 | 10.3 | 7.8 | 2 | 2 | 10.3 | 7.8 | 2 | 2 |
| 10.2a | ≥ 98 | 11.3 | 7.3 | 11.3 | 7.8 | 2 | 2 | 11.3 | 7.8 | 2 | 2 | 11.3 | 7.8 | 2 | 2 |
| 14.5a | ≥ 100 | 15.6 | 7.4 | 15.6 | 7.9 | 2 | 2 | 15.6 | 7.9 | 2 | 2 | Not recommended | | | |
| Abbreviations: W = overall flange width H = overall flange height R = flange radius T = flange thickness | | | | | | | | | | | | | | | |

Technical information

| Profile type | Profile ϕ (mm) | Performance (stainless steel only) |
|-----------------------|---------------------------------------|--|
| 5.0a 6.0a 6.6b | ≥ 82 ≥ 82 ≥ 90 | <p>Profile 1mm</p> <p>Graph showing pressure (bar) vs. inner diameter (mm) for Profile 1mm. The y-axis ranges from 0 to 5 bar, and the x-axis ranges from ϕ 100 to ϕ 600 mm. Three data series are shown: 20 C (blue squares), 200 C (green triangles), and 400 C (red circles). All series show a decrease in pressure as the inner diameter increases, with 20 C having the highest pressure and 400 C the lowest.</p> |
| 4.0b 7.9b 14.5a | ≥ 89 ≥ 108 ≥ 100 | <p>Profile 1.5mm</p> <p>Graph showing pressure (bar) vs. inner diameter (mm) for Profile 1.5mm. The y-axis ranges from 0 to 12 bar, and the x-axis ranges from ϕ 100 to ϕ 600 mm. Three data series are shown: 20 C (blue squares), 200 C (green triangles), and 400 C (red circles). All series show a decrease in pressure as the inner diameter increases, with 20 C having the highest pressure and 400 C the lowest.</p> |
| 10.2a 11.4b | ≥ 98 ≥ 180 | <p>Profile 2.0mm</p> <p>Graph showing pressure (bar) vs. inner diameter (mm) for Profile 2.0mm. The y-axis ranges from 0 to 20 bar, and the x-axis ranges from ϕ 100 to ϕ 600 mm. Three data series are shown: 20 C (blue squares), 200 C (green triangles), and 400 C (red circles). All series show a decrease in pressure as the inner diameter increases, with 20 C having the highest pressure and 400 C the lowest.</p> |

1. Determine the **application or test pressure**.
2. Determine the **max. operating temperature** to which the profile clamp will be exposed.
(Note: The profile clamps presented in this catalogue have been designed for a maximum operating temperature of 400 °C.)
3. Calculate the required inner diameter of the profile as follows:
outer flange diameter + 3 mm
4. Using the diagrams on the left. Check whether the profile thickness you have selected will be sufficient.
(Note: The result only represents an initial approximation based on static pressures and ideal operating conditions.)

Other factors may come into play, such as:

- Shape of and material used for sealing measures
- Roughness of flange surface
- Operating temperatures
- Bending moments
- Pressure surges/Vibrations
- Safety requirements

Based on these factors, you may decide that a thicker profile is necessary.

5. The tables below provide information on the tightening torques for the various closure types and bolt sizes.
- 5.1. Recommended tightening torque for STC & QRC-type closures:

| Band with | Bolt | Tightening torque |
|-----------|------|-------------------|
| 20 mm | M 6 | 6 Nm +/-1 |
| 25 mm | M 8 | 12 Nm +/-1 |

Example of application:

- Operating pressure: 4 bar (static)
- Temperature: 20 °C
- Profile type: 4.0b
- Profile thickness: 1.5 mm
- Flange diameter: ϕ 197 mm
- Inner profile diameter: ϕ 200 mm

Max. permissible pressure at 20 °C:

- 5.4 bar > 4 bar <OK

V PROFILE CLAMPS

Application areas

NORMACONNECT® V profile clamps are quick-release connecting elements for flanges and represent an economical alternative to conventional bolted flange connections.



Automotive:
Turbocharger – catalytic
converter connection

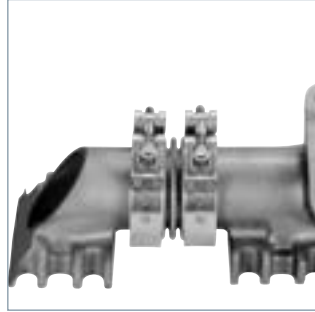

Automotive:
Exhaust manifold



Industry:
Bulk material container



Industry:
Bypass filter unit



The NORMACONNECT® V QRC come with a unique quick release closure for rapid assembly. The V QRC clamps are used in different segments of exhaust systems as well as turbocharger installations and offer excellent corrosion resistance properties.

Advantages at a glance

- Rapid closing and opening
- Captive closure components
- Significantly shorter installation
- Closure bolt secured during tightening

Material

W4

| NORMACONNECT® V QRC | | | | | | | | |
|---------------------|-----------|--------------------|---------|---------|---------|---------|---------|---------------|
| Designation | Ø DN (mm) | Profile dimensions | | | | | | W4 Part No. |
| | | w1 (mm) | w2 (mm) | h1 (mm) | h2 (mm) | Ø1 (mm) | Ø2 (mm) | |
| V-QRC 077 | 77 | 6.6 | - | 4.7 | - | 40° | - | 0633 0580 077 |
| V-QRC 077 | 77 | 8.2 | 17 | 4.0 | - | 40° | - | 0633 0578 077 |
| V-QRC 080 | 80 | 4.5 | 13.6 | 5.8 | 7.5 | 40° | 70° | 0633 0579 080 |
| V-QRC 080 | 80 | 8.7 | - | 5.8 | 7.6 | 40° | 90° | 0633 0577 080 |
| V-QRC 082 | 82 | 4.3 | 13.6 | 4.0 | 7.0 | 40° | - | 0633 2633 082 |
| V-QRC 085 | 85 | 9 | - | 7.0 | - | 40° | - | 0633 0576 085 |
| V-QRC 097 | 97 | 7.9 | - | 5.2 | - | 40° | - | 0633 0575 097 |
| V-QRC 098 | 98 | 8.8 | - | 5.4 | 7.5 | 40° | 90° | 0633 3633 098 |
| V-QRC 103 | 103 | 6.5 | - | 3.6 | 5.05 | 40° | 90° | 0633 0574 103 |
| V-QRC 108 | 108 | 13.6 | - | 4.0 | 7.0 | 40° | - | 0633 2633 108 |
| V-QRC 112 | 112 | 6.5 | - | 7.8 | - | 40° | - | 0633 4633 112 |
| V-QRC 115 | 115 | 7.9 | - | 5.4 | 7.8 | 40° | 90° | 0633 2633 115 |
| V-QRC 124 | 124 | 6.5 | - | 4.6 | - | 40° | - | 0633 0571 124 |
| V-QRC 131 | 131 | 6.5 | 20 | 7.2 | - | 40° | - | 0633 4633 131 |
| V-QRC 135 | 135 | 6.5 | - | 7.8 | - | 40° | - | 0633 4633 135 |
| V-QRC 143 | 143 | 7.9 | - | 5.8 | 7.5 | 40° | 90° | 0633 1633 143 |
| V-QRC 145 | 145 | 6.5 | - | 7.8 | - | 40° | - | 0633 4633 145 |
| V-QRC 155 | 146 | 6.5 | 20 | 7.2 | - | 40° | - | 0633 4633 146 |
| V-QRC 152 | 152 | 9.2 | - | 6.8 | - | 40° | - | 0633 0572 152 |
| V-QRC 152 | 152 | 7.9 | - | 5.8 | 7.0 | 40° | 90° | 0633 1633 152 |
| V-QRC 155 | 155 | 6.5 | - | 7.8 | - | 40° | - | 0633 4633 155 |
| V-QRC 179 | 179 | 7.9 | - | 5.3 | 7.5 | 40° | 90° | 0633 2633 179 |
| V-QRC 185 | 185 | 7.9 | - | 5.8 | 7.5 | 40° | 90° | 0633 1633 185 |
| V-QRC 317 | 317 | 7.9 | - | 5.8 | 7.5 | 40° | 90° | 0632 4632 317 |
| NORMACONNECT® V STC | | | | | | | | |
| V-STC 219 | 219 | 7.9 | - | 5.8 | 7.5 | 40° | 90° | 0632 2632 219 |
| V-STC 404 | 404 | 6.5 | - | 7.8 | - | 40° | - | 0632 4632 404 |

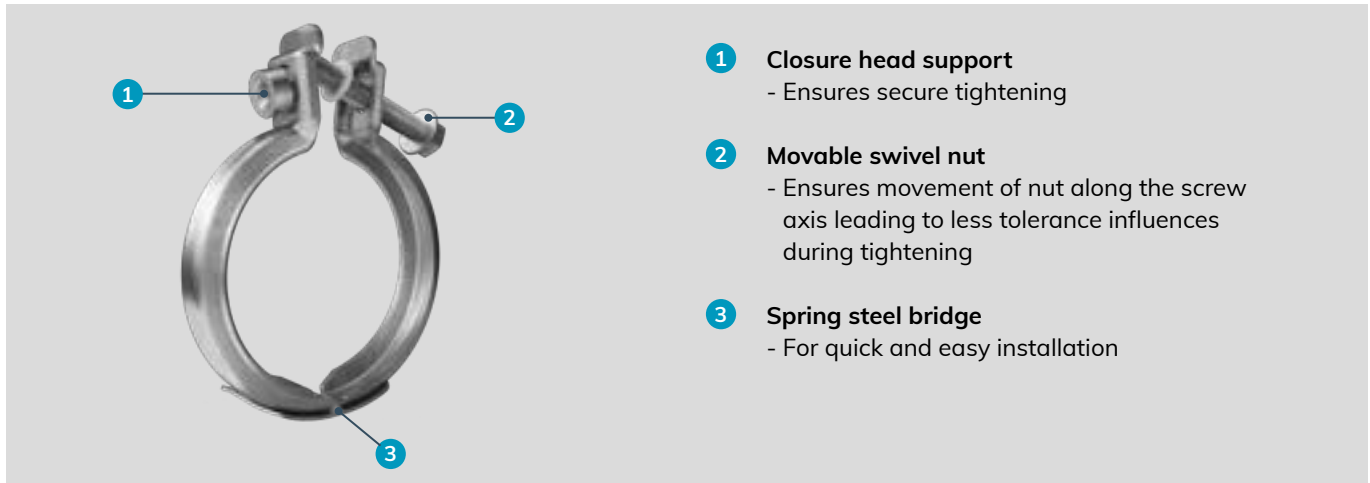

- 1 Closure head support**
- Ensures secure tightening
- 2 Movable swivel nut**
- Ensures movement of nut along the screw axis leading to less tolerance influences during tightening
- 3 Spring steel bridge**
- For quick and easy installation

High performance profile clamp

NORMACONNECT® VPP Bridge is a high performance clamp designed to withstand extreme temperatures upto 1050 °C. It is designed for easy and quick installation and high clamping forces.

Advantages at a glance

- ✔ Operates at higher temperatures than conventional profile clamps
- ✔ Quick and easy installation due to spring bridge
- ✔ Higher clamping force than conventional clamps
- ✔ Minimum installation space required

Applications

The VPP bridge clamps offer a connection solution to applications exposed to high temperatures. It is used in different segments of exhaust systems as well as turbocharger installations. A typical application are petrol turbocharger connections.

Materials

| | | | | |
|----|----|----|----|----|
| W1 | W2 | W3 | W4 | W5 |
| | | | | x |

Technical drawing

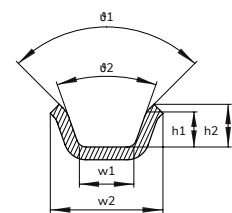

Technical data & Ordering information

| NORMACONNECT® VPP BRIDGE | | | | | | | | |
|--------------------------|-----------|--------------------|---------|---------|---------|---------|---------|---------------|
| Designation | Ø DN (mm) | Profile dimensions | | | | | | W5 Part No. |
| | | w1 (mm) | w2 (mm) | h1 (mm) | h2 (mm) | Ø1 (mm) | Ø2 (mm) | |
| VPP Bridge 079 | 79 | 8.55 | 17.15 | 5.5 | 6.7 | 39° | 90° | 0168 0000 079 |
| VPP Bridge 083 | 83 | 8.55 | 17.15 | 5.5 | 6.7 | 39° | 90° | 0168 0000 083 |
| VPP Bridge 086 | 86 | 8.55 | 17.15 | 5.5 | 6.7 | 39° | 90° | 0168 0000 086 |
| VPP Bridge 094 | 94 | 8.55 | 17.15 | 5.5 | 6.7 | 39° | 90° | 0168 0000 094 |
| VPP Bridge 096 | 96 | 8.55 | 17.15 | 5.5 | 6.7 | 39° | 90° | 0168 0000 096 |
| VPP Bridge 098 | 98 | 8.55 | 17.15 | - | 6.0 | 40° | - | 0168 0000 098 |
| VPP Bridge 101 | 101 | 8.55 | 17.15 | 5.8 | 7.2 | 39° | 90° | 0168 0000 101 |
| VPP Bridge 107 | 107 | 8.55 | 17.15 | 5.5 | 6.7 | 39° | 90° | 0168 0000 107 |
| VPP Bridge 113 | 113 | 8.55 | 17.15 | 5.5 | 6.7 | 39° | 90° | 0168 0000 113 |
| VPP Bridge 120 | 120 | 8.55 | 17.15 | 5.5 | 6.7 | 39° | 90° | 0168 0000 120 |
| VPP Bridge 138 | 138 | 8.55 | 17.15 | 5.3 | 6.7 | 39° | 90° | 0168 0000 138 |

NORMAFIX® – Retaining Products

Versatile products for a whole host of applications

The NORMAFIX® range of clamps, clips and systems for retaining pipes, cables, cable harnesses and hoses are ready for action wherever they're needed – walls, ceilings or car bodies.



CABLE TIES



Smooth round edges

- easier to handle and safer to install

Variety of colors

- available in: black, white, red, yellow, green, blue

“Carbon Black” added in black cable tie flange

- increased resistance to UV rays
- suitable for outdoor use

Quick and safe securing of cables in material PA 6.6

NORMAFIX® Cable Tie for securing cables in electrical installations, industrial wiring, automotive, etc. Made of polyamide 6.6. Resistant to extreme temperatures and numerous external agents. Quick and safe assembly. The black cable tie offers excellent resistance to UV rays thanks to added “carbon black.”



Advantages at a glance

- ✓ Made of polyamide 6.6 for optimum resistance to extreme temperatures, bases, oils, greases, etc.
- ✓ Bent rounded tip allows easier insertion through the head of the cable ties
- ✓ Low-friction material coefficient allows a faster installation

Applications

- Electrical installations
- Industrial cabling
- Automotive cabling
- Marine cabling
- Panel building
- Special applications

Materials

Polyamide 6.6: Characteristics of raw material

| | |
|------------------------------|---------------------------------|
| Working temperature: | -45 °C to 85 °C |
| Tightening temperature: | -10 °C to 60 °C |
| Max admissible point: | 120 °C* |
| Melting temperature: | 256 °C |
| Limiting Oxygen Index (LOI): | 27 % |
| Recovery of moisture: | 2.7 % to 50 % relative humidity |

Halogen free: Evaluated according to EN 50146.

Flame retardancy according to UL 94-V2

Resistance to external agents

- Excellent resistance to aromatic solvents, bases, oils, fat, petroleum products
- Maintain limited contact with acid
- Not resistant to phenol and chlorinated solvents
- Resistance to UV (black colored cable ties)**

Information

EC directives

The material used to produce our cable ties complies with the following EC directives:

- 2000/53/EC (VHU)
- 2002/65/UE (RoHS)
- 2002/96/EC (DEEE)
- 2006/95/EC

* (for a short time)

** The black cable ties are loaded with carbon black. Therefore they possess UV resistance according to standard ISO QUV-B 4892 (150 hours), equivalent to 3 years of exposure to sunlight. They are also particularly recommended for external applications.

Technical data & Ordering information

| NORMAFIX® CABLE TIES | | | | | | | | | | |
|----------------------|-----------------------|--------------|------------------------|-------------------------------|-------------------|-------------------|-----------------|--------------------|-------------------|------------------|
| Width | Designation | Length in mm | Maximum diameter in mm | Resistance to traction in kgs | White Product No. | Black Product No. | Red Product No. | Yellow Product No. | Green Product No. | Blue Product No. |
| 2.5 | CABLE TIE 2.5 x 98 | 98 | 21 | 8 | 0860 0110 201 | 0860 0210 201 | 0860 0310 201 | 0860 0320 201 | 0860 0330 201 | 0860 0340 201 |
| 2.6 | CABLE TIE 2.6 x 160 | 160 | 40 | 8 | 0860 0110 302 | 0860 0210 302 | | | | |
| 3.5 | CABLE TIE 3.5 x 140 | 140 | 35 | 13 | 0860 0110 401 | 0860 0210 401 | 0860 0310 401 | 0860 0320 401 | 0860 0330 401 | 0860 0340 401 |
| | CABLE TIE 3.5 x 200 | 200 | 50 | 13 | 0860 0110 402 | 0860 0210 402 | 0860 0310 402 | 0860 0320 402 | 0860 0330 402 | 0860 0340 402 |
| | CABLE TIE 3.5 x 290 | 290 | 80 | 13 | 0860 0110 403 | 0860 0210 403 | | | | |
| | CABLE TIE 3.5 x 370 | 370 | 103 | 13 | 0860 0110 404 | 0860 0210 404 | | | | |
| 4.5 | CABLE TIE 4.5 x 120 | 120 | 24 | 20 | 0860 0110 501 | 0860 0210 501 | | | | |
| | CABLE TIE 4.5 x 160 | 160 | 40 | 20 | 0860 0110 502 | 0860 0210 502 | | | | |
| | CABLE TIE 4.5 x 200 | 200 | 50 | 22 | 0860 0110 602 | 0860 0210 602 | 0860 0310 601 | 0860 0320 601 | 0860 0330 601 | 0860 0340 601 |
| 4.8 | CABLE TIE 4.8 x 178 | 178 | 45 | 22 | 0860 0110 601 | 0860 0210 601 | | | | |
| | CABLE TIE 4.8 x 250 | 250 | 68 | 22 | 0860 0110 603 | 0860 0210 603 | | | | |
| 4.5 | CABLE TIE 4.5 x 290 | 290 | 79 | 22 | 0860 0110 604 | 0860 0210 604 | 0860 0310 602 | 0860 0320 602 | 0860 0330 602 | 0860 0340 602 |
| | CABLE TIE 4.5 x 360 | 360 | 103 | 22 | 0860 0110 605 | 0860 0210 605 | | | | |
| 4.8 | CABLE TIE 4.8 x 390 | 390 | 106 | 22 | 0860 0110 606 | 0860 0210 606 | | | | |
| 4.5 | CABLE TIE 4.5 x 430 | 430 | 115 | 22 | 0860 0110 607 | 0860 0210 607 | | | | |
| 7.8 | CABLE TIE 7.8 x 180 | 180 | 45 | 55 | 0860 0110 702 | 0860 0210 702 | | | | |
| | CABLE TIE 7.8 x 240 | 240 | 63 | 55 | 0860 0110 703 | 0860 0210 703 | | | | |
| | CABLE TIE 7.8 x 300 | 300 | 80 | 55 | 0860 0110 704 | 0860 0210 704 | | | | |
| 7.5 | CABLE TIE 7.5 x 365 | 365 | 100 | 55 | 0860 0110 705 | 0860 0210 705 | | | | |
| | CABLE TIE 7.5 x 450 | 450 | 130 | 55 | 0860 0110 706 | 0860 0210 706 | | | | |
| | CABLE TIE 7.5 x 540 | 540 | 158 | 55 | 0860 0110 707 | 0860 0210 707 | | | | |
| | CABLE TIE 7.5 x 750 | 750 | 200 | 55 | 0860 0110 708 | 0860 0210 708 | | | | |
| 9 | CABLE TIE 9 x 780 | 780 | 233 | 77 | 0860 0110 801 | 0860 0210 801 | | | | |
| 12.5 | CABLE TIE 12.5 x 500 | 500 | 143 | 110 | 0860 0110 902 | 0860 0210 902 | | | | |
| | CABLE TIE 12.5 x 1000 | 1000 | 302 | 110 | 0860 0110 905 | 0860 0210 905 | | | | |

NORMAFIX®



Refer to pages 192 and 197

CABLE TIE WITH METAL BARB

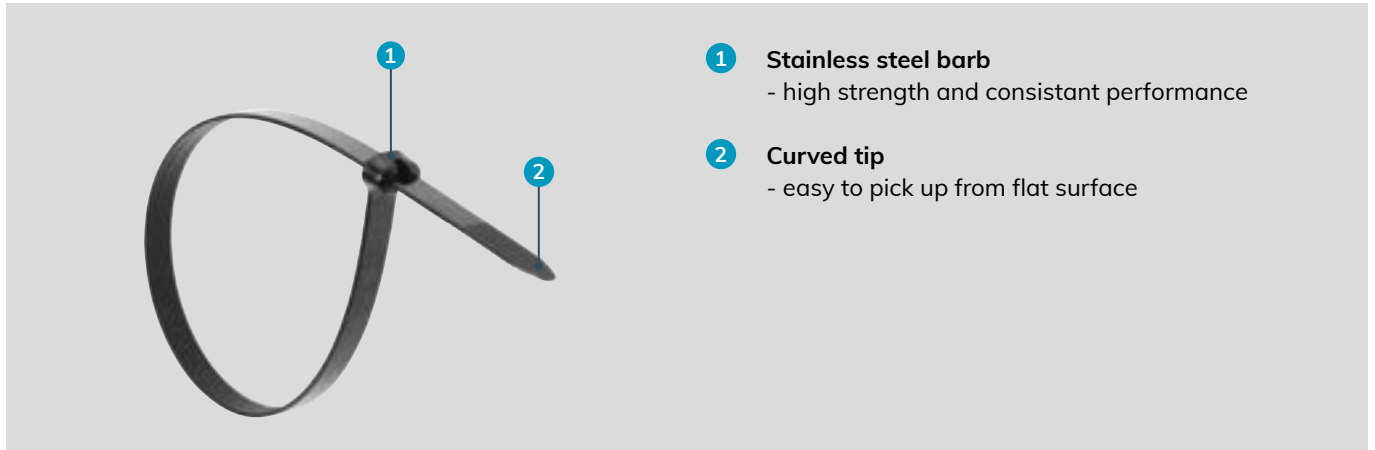

- 1 Stainless steel barb**
- high strength and consistent performance
- 2 Curved tip**
- easy to pick up from flat surface

Cable tie for high strength fixing

Made of Nylon 66 and 304 barb; this cable tie is a better choice for high strength applications.

Advantages at a glance

- ✓ Stainless steel barb provides consistent performance and reliability and infinite adjustability through entire bundle range
- ✓ High strength and low thread force
- ✓ Stippled strap body prevents lateral movement on the bundle
- ✓ Curved tip is easy to pick up from flat surface and allows faster initial threading to speed installation

Applications

- Electrical installations
- Industrial cabling
- Automotive cabling
- Marine cabling
- Panel building
- Special applications

Materials

Band: Nylon 66
Locking barb: SS 304 (W4)

Information

Our cable ties comply with the following directives:

- ABS (Product Approval)
- CE (Certificate of conformity)
- UL62275 (Cable management systems)
- Lloyd's Register
- DNV
- DNV GL
- RoHS

Characteristics

Material-Locking Barb: Stainless Steel 304
Working Temp: -40 °C to +85 °C
Color: Black and White
Flammability: UL94V-2
Other Properties: Halogen Free, UV-resistant (black cable ties)

Technical data & Ordering information

| NORMAFIX® CABLE TIE WITH METAL BARB | | | |
|-------------------------------------|-------------------------------------|--------------|-------------------|
| Width in mm | Designation | Length in mm | Black Product No. |
| 2.4 | CABLE TIE WITH METAL BARB 2.4 X 102 | 102 | 0892 7118 001 |
| | CABLE TIE WITH METAL BARB 2.4 X 201 | 201 | 0892 7118 003 |
| 3.6 | CABLE TIE WITH METAL BARB 3.6 X 155 | 155 | 0892 7118 006 |
| | CABLE TIE WITH METAL BARB 3.6 X 200 | 200 | 0892 7118 009 |
| | CABLE TIE WITH METAL BARB 3.6 X 284 | 284 | 0892 7118 007 |
| 4.8 | CABLE TIE WITH METAL BARB 4.8 X 186 | 186 | 0892 7118 011 |
| | CABLE TIE WITH METAL BARB 4.8 X 250 | 250 | 0892 7118 010 |
| | CABLE TIE WITH METAL BARB 4.8 X 295 | 295 | 0892 7118 012 |
| | CABLE TIE WITH METAL BARB 4.8 X 361 | 361 | 0892 7118 013 |
| 7.0 | CABLE TIE WITH METAL BARB 7.0 X 221 | 221 | 0892 7118 016 |
| | CABLE TIE WITH METAL BARB 7.0 X 378 | 378 | 0892 7118 018 |
| | CABLE TIE WITH METAL BARB 7.0 X 699 | 699 | 0892 7118 021 |



Refer to pages 192 and 197

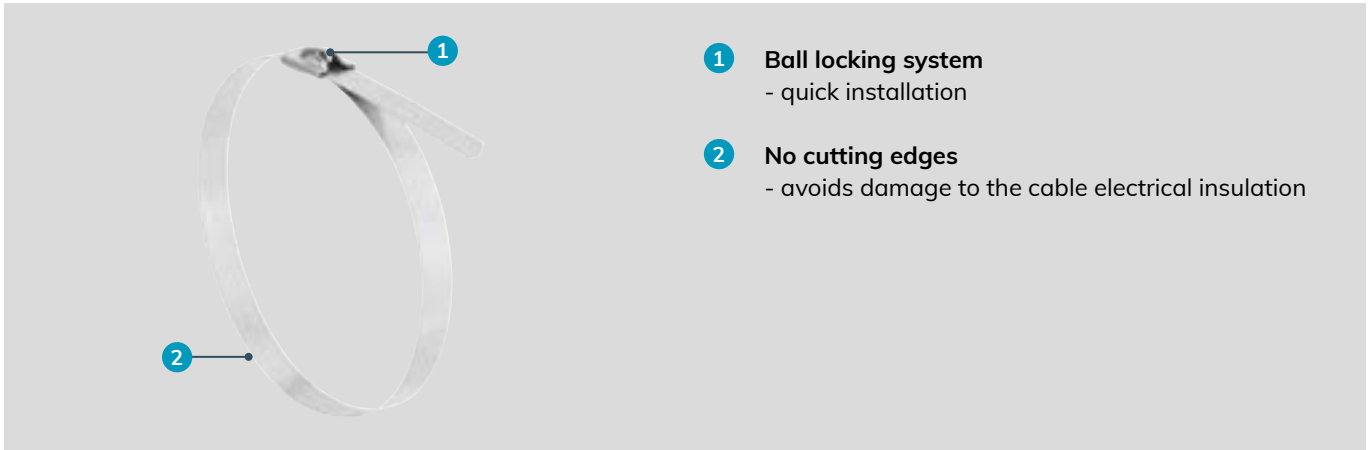

- 1 Ball locking system**
- quick installation
- 2 No cutting edges**
- avoids damage to the cable electrical insulation

Cable tie for high strength fixing

Made of stainless steel AISI 304 or AISI 316 with ball locking system, that enables quick installation and low insertion effort. This kind of cable tie is characterized by a high resistance to high temperature, to flame and corrosion.

Advantages at a glance

- ✓ Ball-lock type self-lock system, speeds installation
- ✓ Made entirely of high grade stainless steel, excellent corrosion and UV resistance.

Materials

Band: Stainless steel AISI 304 or 316

Technical data & Ordering information

Information

Our cable ties comply with the following directives:

- ABS (Product Approval)
- CE (Certificate of conformity)
- UL62275 (Cable management systems)
- Lloyd's Register
- DNV
- DNV GL
- RoHS

Characteristics

Made entirely of Stainless Steel
 Working Temp: -80 °C to +300 °C
 Flammability: Fireproof
 Other Properties: UV-resistant

Applications

- Cable and pipe fixing in shipbuilding, offshore, petrochemical plants, oil rigs, and environments with a risk of fire.
- Used as flame safety in electrical installations to fix the metal I.D. plates, which must be preserved in the event fire.
- Installations where high mechanical and UV resistance are required (photovoltaic).

| NORMAFIX® STAINLESS STEEL BALL LOCKING CABLE TIE | | | | |
|--|--|--|----------------|----------------|
| Width in mm | Designation | Length in mm | W4 Product No. | W5 Product No. |
| 4.6 | STAINLESS STEEL BALL LOCKING CABLE TIE 4.6x200 | 200 | 0892 7012 002 | 0892 7012 047 |
| | STAINLESS STEEL BALL LOCKING CABLE TIE 4.6x250 | 250 | 0892 7012 003 | 0892 7012 048 |
| | STAINLESS STEEL BALL LOCKING CABLE TIE 4.6x350 | 350 | 0892 7012 005 | 0892 7012 049 |
| | STAINLESS STEEL BALL LOCKING CABLE TIE 4.6x450 | 450 | 0892 7012 007 | 0892 7012 050 |
| | STAINLESS STEEL BALL LOCKING CABLE TIE 4.6x650 | 650 | 0892 7012 042 | 0892 7012 051 |
| | STAINLESS STEEL BALL LOCKING CABLE TIE 4.6x800 | 800 | 0892 7012 043 | 0892 7012 052 |
| | 7.8 | STAINLESS STEEL BALL LOCKING CABLE TIE 7.6x200 | 200 | 0892 7012 010 |
| STAINLESS STEEL BALL LOCKING CABLE TIE 7.6x250 | | 250 | 0892 7012 011 | 0892 7012 054 |
| STAINLESS STEEL BALL LOCKING CABLE TIE 7.6x350 | | 350 | 0892 7012 013 | 0892 7012 055 |
| STAINLESS STEEL BALL LOCKING CABLE TIE 7.6x500 | | 500 | 0892 7012 016 | 0892 7012 056 |
| STAINLESS STEEL BALL LOCKING CABLE TIE 7.6x650 | | 650 | 0892 7012 044 | 0892 7012 057 |
| STAINLESS STEEL BALL LOCKING CABLE TIE 7.6x800 | | 800 | 0892 7012 045 | 0892 7012 058 |
| STAINLESS STEEL BALL LOCKING CABLE TIE 7.6x1000 | | 1000 | 0892 7012 046 | 0892 7012 059 |



Refer to page 192

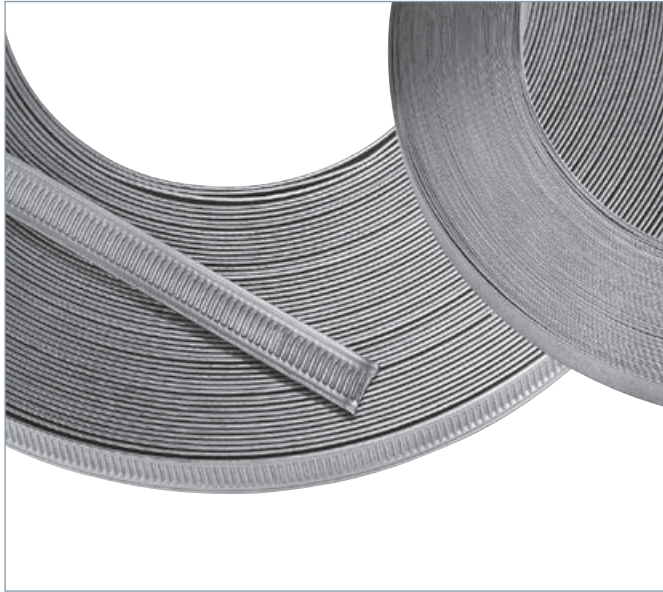

Continuous band available in smooth version or with thread stamping throughout

4 different closure types to suit a huge variety of applications



Continuous band clamping system

Consisting of a continuous band, the NORMAFIX® NORMETTA® system is able to adapt itself to the shape and size of various objects. 4 different types of closure are available to choose from. The system is particularly suitable for carrying out retaining and repair work under difficult and extreme conditions.

Advantages at a glance

- ✓ Flexible and versatile
- ✓ Can be installed under difficult conditions

Materials

| W1 | W2 | W3 | W4 | W5 |
|----|----|----|----|----|
| | x | x | x | |

Applications

- Irrigation systems
- Railway industry
- Building machines
- Pump and filter
- Retaining applications; sealing pipes during repair work
- Attaching signs and containers
- Binding hoses



Product and closure types

The continuous band is available in three different versions: smooth band, stamped band or perforated band. Depending on the version, you will have a different choice of band widths, material grades and closure types.

Smooth band



To be used with the buckles, NB-D W4 and NB-H W4.

| NORMAFIX® NORMETTA® SMOOTH BAND | | | | |
|---------------------------------|-----------------|--------------------------------|-------------|----------------|
| Width in mm | Thickness in mm | Designation | Length in m | W4 Product No. |
| 9 | 0.5 | NORMETTA SMOOTH BAND 30M/9 W4 | 30 | 0560 8554 009 |
| 13 | 0.7 | NORMETTA SMOOTH BAND 30M/13 W4 | 30 | 0560 8553 013 |
| 16 | 0.7 | NORMETTA SMOOTH BAND 30M/16 W4 | 30 | 0560 8553 016 |
| 19 | 0.7 | NORMETTA SMOOTH BAND 30M/19 W4 | 30 | 0560 8553 019 |

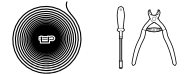

Refer to pages 186 and 192

Stamped band



To be used with the buckles NB-G W3.

| NORMAFIX® NORMETTA® STAMPED BAND | | | | | |
|----------------------------------|-----------------|---------------------------------|-------------|-----------------------------|----------------|
| Width in mm | Thickness in mm | Designation | Length in m | Resistance to traction in N | W3 Product No. |
| 12 | 0.8 | NORMETTA STAMPED BAND 30M/12 W3 | 30 | 2600 N | 0560 8566 003 |



Refer to page 192

Perforated Band



To be used with buckles NB-K W2.

| NORMAFIX® NORMETTA® PERFORATED BAND | | | | | | |
|-------------------------------------|-----------------|------------------------------------|-------------|-----------------------------|----------------|----------------|
| Width in mm | Thickness in mm | Designation | Length in m | Resistance to traction in N | W2 Product No. | W4 Product No. |
| 8 | 0.6 | NORMETTA PERFORATED BAND 25M/8 W2 | 25 | 790 N | 0817 7020 001 | |
| | 0.6 | NORMETTA PERFORATED BAND 25M/8 W4 | 25 | 790 N | | 0817 7022 001 |
| 13 | 0.6 | NORMETTA PERFORATED BAND 25M/13 W4 | 25 | 850 N | | 0817 7022 002 |
| 14 | 0.6 | NORMETTA PERFORATED BAND 25M/14 W2 | 25 | 850 N | 0817 7020 002 | |



Refer to page 192

NORMETTA® – CLOSURE TYPES

NB-D



Closure type NB-D

Suitable for attaching signs and containers to pipes and hoses as well as binding hoses.

For bands: 9, 13, 16, 19 mm

Required tools: Clamping and cutting tool; hammer

| NORMAFIX® NB-D | | |
|----------------------|-------------|-------------------|
| For band width in mm | Designation | W4 Product No. |
| 9 | NB-D/9 | 0560 8550 009 |
| 13 | NB-D/13 | 0560 8550 013 |
| 16 | NB-D/16 | 0560 8550 016 |
| 19 | NB-D/19 | 0560 8550 019 |



Refer to page 192

NB-G



Closure type NB-G

Suitable for applications with cramped installation conditions.

Can be re-used.

For stamped bands.

Required tools: Screwdriver or SW7 socket wrench and plate shears

| NORMAFIX® NB-G | | |
|----------------------|-------------|-------------------|
| For band width in mm | Designation | W3 Product No. |
| 12 | NB-G/12 | 0560 8565 003 |

NB-H



Closure type NB-H

An adjustable quick-release closure that enables fast and easy installation and removal. Can be re-used.

For bands: 16, 19 mm

Required tools: Screwdriver and plate shears

| NORMAFIX® NB-H | | | |
|----------------------|------------------------|-------------|----------------|
| For band width in mm | Maximum diameter in mm | Designation | W1 Product No. |
| 16 / 19 | 124 | NB-H/124 | 0560 8558 124 |
| | 400 | NB-H/400 | 0560 8558 400 |
| | 800 | NB-H/800 | 0560 8558 800 |

NB-K



Closure type NB-K

Suitable for fixing suspended ventilation tubes.

For bands: 8, 13, 14 mm

Required tools: Screwdriver

| NORMAFIX® NB-K | | | |
|----------------------|-------------|----------------|----------------|
| For band width in mm | Designation | W2 Product No. | W4 Product No. |
| 8 | NB-K/8 | 0817 7019 003 | 0817 7021 003 |
| 13 | NB-K/13 | | 0817 7021 004 |
| 14 | NB-K/14 | 0817 7019 004 | |



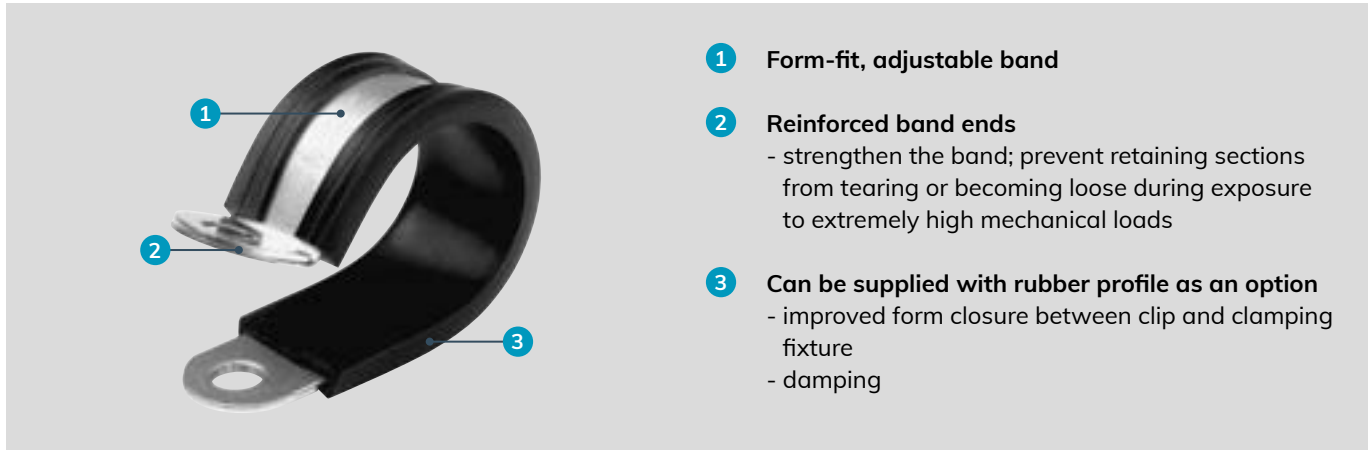

- 1 **Form-fit, adjustable band**
- 2 **Reinforced band ends**
 - strengthen the band; prevent retaining sections from tearing or becoming loose during exposure to extremely high mechanical loads
- 3 **Can be supplied with rubber profile as an option**
 - improved form closure between clip and clamping fixture
 - damping

Pipe retaining clips in accordance with DIN 3016

NORMAFIX® RS/RSGU pipe retaining clips are suitable for all kinds of fastening and retaining applications: pipes, cables, cable harnesses, cable protection pipes, hoses and other lines.



Advantages at a glance

- ✓ Easy installation and secure fastening
- ✓ Reinforced band ends for extremely high mechanical loads
- ✓ Rubber profile protects against vibrations and creeping water, is sound-absorbent and protects against contact corrosion

Applications

- Machine building
- White goods
- Chemical industry
- Irrigation systems
- Ship manufacturing
- Food and beverage industry
- Railway industry
- Agricultural machines
- Building machines
- Engine manufacturing
- Pump and filter
- Mining industry

Materials

| W1 | W2 | W3 | W4 | W5 |
|----|----|----|----|----|
| x | | x* | x* | x |

*W3 and W4 on request

Bolts

The scope of delivery does not include bolts or nuts.
 We recommend:
 For NORMAFIX® RSGU with 12 mm band width: M5 bolt
 For NORMAFIX® RSGU with 15 mm band width: M6 bolt
 For NORMAFIX® RSGU with 20 mm band width: M8 bolt

Rubber profile

| Material properties of EPDM rubber profile | | |
|--|-----------------------------|--------------|
| Tensile strength [N/mm ²] | | Min. 8 |
| Elongation at break [%] | | 350 |
| Shore hardness A | | 70 ± 5 |
| Temperature [°C] | | -40 to +120 |
| Resistance to: | Weather/Ozone | Very good |
| | Aging/UV | Very good |
| | Fuel storage | Not suitable |
| | Storage in oils and greases | Not suitable |
| | Alcohols | Good |
| | Acids | Good |
| | Alkalis | Good |

Silicone rubber profile also available on request.

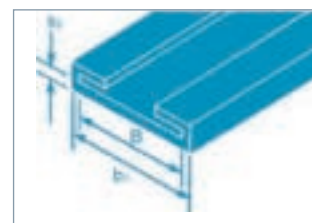

B = band width of clip

b₁ = width in mm

s₂ = material thickness in mm

Technical data & Ordering information

| NORMAFIX® RSGU 1 | | | | | | | | |
|---------------------|--------------|-----------------|-----------|---------------|-------------|---------------|-------------------|-------------------|
| Band width in mm | Designation | Clamping ranges | | h1 ~ in mm | b1 in mm | s2 in mm | W1 Product No. | W5 Product No. |
| | | in mm | in inches | | | | | |
| 12 | RSGU1. 6/12 | 6 | 1/4" | 8.0+ | 15.0 | 1.2 | 0941 8912 006 | 0941 7712 006 |
| | RSGU1. 8/12 | 8 | 5/16" | 8.0+ | 15.0 | 1.2 | 0941 8912 008 | 0941 7712 008 |
| | RSGU1. 10/12 | 10 | 3/8" | 8.0+ | 15.0 | 1.2 | 0941 8912 010 | 0941 7712 010 |
| | RSGU1. 12/12 | 12 | 1/2" | 8.0+ | 15.0 | 1.2 | 0941 8912 012 | 0941 7712 012 |
| | RSGU1. 13/12 | 13 | 1/2" | 8.0+ | 15.0 | 1.2 | 0941 8912 013 | 0941 7712 013 |
| | RSGU1. 14/12 | 14 | 9/16" | 8.0+ | 15.0 | 1.2 | 0941 8912 014 | 0941 7712 014 |
| | RSGU1. 15/12 | 15 | 5/8" | 8.0+ | 15.0 | 1.2 | 0941 8912 015 | 0941 7712 015 |
| | RSGU1. 16/12 | 16 | 5/8" | 8.0+ | 15.0 | 1.2 | 0941 8912 016 | 0941 7712 016 |
| | RSGU1. 18/12 | 18 | 3/4" | 8.0+ | 15.0 | 1.2 | 0941 8912 018 | 0941 7712 018 |
| | RSGU1. 19/12 | 19 | 3/4" | 8.0+ | 15.0 | 1.2 | 0941 8912 019 | 0941 7712 019 |
| | RSGU1. 20/12 | 20 | 13/16" | 8.0+ | 15.0 | 1.2 | 0941 8912 020 | 0941 7712 020 |
| | RSGU1. 21/12 | 21 | 13/16" | 8.0+ | 15.0 | 1.2 | 0941 8912 021 | 0941 7712 021 |
| RSGU1. 22/12 | 22 | 7/8" | 8.0+ | 15.0 | 1.2 | 0941 8912 022 | 0941 7712 022 | |
| 15 | RSGU1. 6/15 | 6 | 1/4" | 11.2+ | 18.5 | 1.5 | 0941 8915 006 | 0941 7715 006 |
| | RSGU1. 8/15 | 8 | 5/16" | 11.2+ | 18.5 | 1.5 | 0941 8915 008 | 0941 7715 008 |
| | RSGU1. 10/15 | 10 | 3/8" | 11.2+ | 18.5 | 1.5 | 0941 8915 010 | 0941 7715 010 |
| | RSGU1. 12/15 | 12 | 1/2" | 11.2+ | 18.5 | 1.5 | 0941 8915 012 | 0941 7715 012 |
| | RSGU1. 13/15 | 13 | 1/2" | 11.2+ | 18.5 | 1.5 | 0941 8915 013 | 0941 7715 013 |
| | RSGU1. 14/15 | 14 | 9/16" | 11.2+ | 18.5 | 1.5 | 0941 8915 014 | 0941 7715 014 |
| | RSGU1. 15/15 | 15 | 5/8" | 11.2+ | 18.5 | 1.5 | 0941 8915 015 | 0941 7715 015 |
| | RSGU1. 16/15 | 16 | 5/8" | 11.2+ | 18.5 | 1.5 | 0941 8915 016 | 0941 7715 016 |
| | RSGU1. 18/15 | 18 | 3/4" | 11.2+ | 18.5 | 1.5 | 0941 8915 018 | 0941 7715 018 |
| | RSGU1. 19/15 | 19 | 3/4" | 11.2+ | 18.5 | 1.5 | 0941 8915 019 | 0941 7715 019 |
| | RSGU1. 20/15 | 20 | 13/16" | 11.2+ | 18.5 | 1.5 | 0941 8915 020 | 0941 7715 020 |
| | RSGU1. 21/15 | 21 | 13/16" | 11.2+ | 18.5 | 1.5 | 0941 8915 021 | 0941 7715 021 |
| | RSGU1. 22/15 | 22 | 7/8" | 11.2+ | 18.5 | 1.5 | 0941 8915 022 | 0941 7715 022 |
| | RSGU1. 23/15 | 23 | 7/8" | 11.2+ | 18.5 | 1.5 | 0941 8915 023 | 0941 7715 023 |
| | RSGU1. 25/15 | 25 | 1" | 11.2+ | 18.5 | 1.5 | 0941 8915 025 | 0941 7715 025 |
| | RSGU1. 26/15 | 26 | 11/16" | 11.2+ | 18.5 | 1.5 | 0941 8915 026 | 0941 7715 026 |
| | RSGU1. 28/15 | 28 | 11/8" | 11.2+ | 18.5 | 1.5 | 0941 8915 028 | 0941 7715 028 |
| | RSGU1. 30/15 | 30 | 13/16" | 11.2+ | 18.5 | 1.5 | 0941 8915 030 | 0941 7715 030 |
| RSGU1. 32/15 | 32 | 11/4" | 11.2+ | 18.5 | 1.5 | 0941 8915 032 | 0941 7715 032 | |
| RSGU1. 34/15 | 34 | 15/16" | 11.2+ | 18.5 | 1.5 | 0941 8915 034 | 0941 7715 034 | |
| RSGU1. 35/15 | 35 | 13/8" | 11.2+ | 18.5 | 1.5 | 0941 8915 035 | 0941 7715 035 | |
| 20 | RSGU1. 10/20 | 10 | 3/8" | 14.5+ | 25.0 | 2.0 | 0941 8920 010 | 0941 7720 010 |
| | RSGU1. 12/20 | 12 | 1/2" | 14.5+ | 25.0 | 2.0 | 0941 8920 012 | 0941 7720 012 |
| | RSGU1. 13/20 | 13 | 1/2" | 14.5+ | 25.0 | 2.0 | 0941 8920 013 | 0941 7720 013 |
| | RSGU1. 14/20 | 14 | 9/16" | 14.5+ | 25.0 | 2.0 | 0941 8920 014 | 0941 7720 014 |
| | RSGU1. 15/20 | 15 | 5/8" | 14.5+ | 25.0 | 2.0 | 0941 8920 015 | 0941 7720 015 |
| | RSGU1. 16/20 | 16 | 5/8" | 14.5+ | 25.0 | 2.0 | 0941 8920 016 | 0941 7720 016 |
| | RSGU1. 18/20 | 18 | 3/4" | 14.5+ | 25.0 | 2.0 | 0941 8920 018 | 0941 7720 018 |
| | RSGU1. 19/20 | 19 | 3/4" | 14.5+ | 25.0 | 2.0 | 0941 8920 019 | 0941 7720 019 |
| | RSGU1. 20/20 | 20 | 13/16" | 14.5+ | 25.0 | 2.0 | 0941 8920 020 | 0941 7720 020 |
| | RSGU1. 22/20 | 22 | 7/8" | 14.5+ | 25.0 | 2.0 | 0941 8920 022 | 0941 7720 022 |
| | RSGU1. 23/20 | 23 | 7/8" | 14.5+ | 25.0 | 2.0 | 0941 8920 023 | 0941 7720 023 |
| | RSGU1. 24/20 | 24 | 15/16" | 14.5+ | 25.0 | 2.0 | 0941 8920 024 | 0941 7720 024 |
| | RSGU1. 25/20 | 25 | 1" | 14.5+ | 25.0 | 2.0 | 0941 8920 025 | 0941 7720 025 |
| | RSGU1. 28/20 | 28 | 11/8" | 14.5+ | 25.0 | 2.0 | 0941 8920 028 | 0941 7720 028 |
| | RSGU1. 30/20 | 30 | 13/16" | 14.5+ | 25.0 | 2.0 | 0941 8920 030 | 0941 7720 030 |
| | RSGU1. 32/20 | 32 | 11/4" | 14.5+ | 25.0 | 2.0 | 0941 8920 032 | 0941 7720 032 |
| | RSGU1. 34/20 | 34 | 15/16" | 14.5+ | 25.0 | 2.0 | 0941 8920 034 | 0941 7720 034 |
| | RSGU1. 35/20 | 35 | 13/8" | 14.5+ | 25.0 | 2.0 | 0941 8920 035 | 0941 7720 035 |
| RSGU1. 36/20 | 36 | 17/16" | 14.5+ | 25.0 | 2.0 | 0941 8920 036 | 0941 7720 036 | |
| RSGU1. 38/20 | 38 | 11/2" | 14.5+ | 25.0 | 2.0 | 0941 8920 038 | 0941 7720 038 | |
| RSGU1. 40/20 | 40 | 19/16" | 14.5+ | 25.0 | 2.0 | 0941 8920 040 | 0941 7720 040 | |

Band width 9 mm and 25 mm available as standard

Additional diameters available on request

Alternative rubber profiles (e.g. silicone) available on request

RS/RSGU – VERSIONS

RSGU 0



| NORMAFIX® RSGU 0 | | | | | |
|------------------|--------------------------|---------------|----------------|------|----------|
| Band width in mm | Min. Clamping range (mm) | Rubber Sleeve | | | |
| | | Width (mm) | Thickness (mm) | EPDM | Silicone |
| 9 | 4 | 12.5 | 1.0 | • | – |
| 12 | 4 | 15.0 | 1.2 | • | • |
| 15 | 5 | 18.5 | 1.5 | • | • |
| 20 | 10 | 25.0 | 2.0 | • | • |
| 25 | 15 | 31.0 | 3.0 | • | • |

Available on request



Refer to page 194

RSGU 2



| NORMAFIX® RSGU 2 | | | | | |
|------------------|--------------------------|---------------|----------------|------|----------|
| Band width in mm | Min. Clamping range (mm) | Rubber Sleeve | | | |
| | | Width (mm) | Thickness (mm) | EPDM | Silicone |
| 9 | 4 | 12.5 | 1.0 | • | – |
| 12 | 4 | 15.0 | 1.2 | • | • |
| 15 | 5 | 18.5 | 1.5 | • | • |
| 20 | 10 | 25.0 | 2.0 | • | • |
| 25 | 15 | 31.0 | 3.0 | • | • |

Available on request



Refer to page 194

RSGUV 1



The NORMAFIX® RSGUV 1 can be pre-positioned on the hose. The locking device keeps the RSGUV 1 safely in place if it needs to be stocked or transported prior to its final assembly.

Available in band widths of 15 and 20 mm, in the same dimensions as our RSGU 1. This system can only be fixed by using a special tool.

Advantages at a glance

- Safe pre-assembly on the hose
- No unintentional opening of the clamp during handling or transportation

Materials

W1, W3, W4, W5



Refer to page 194

RS 1



| NORMAFIX® RS 1 | | | | | | | | | |
|------------------|-------------|-----------------|-----------|----------|------------|---------|---------------|----------------|----------------|
| Band width in mm | Designation | Clamping ranges | | d in mm | h1 ~ in mm | l in mm | s in mm | W1 Product No. | W5 Product No. |
| | | in mm | in inches | | | | | | |
| 12 | RS 1. 6/12 | 6 | 1/4" | 5.3 (M5) | 6.8+ | 5.0 | 0.5 | 0411 8912 006 | 0411 7712 006 |
| | RS 1. 8/12 | 8 | 5/16" | 5.3 (M5) | 6.8+ | 5.0 | 0.5 | 0411 8912 008 | 0411 7712 008 |
| | RS 1. 10/12 | 10 | 3/8" | 5.3 (M5) | 6.8+ | 5.0 | 0.5 | 0411 8912 010 | 0411 7712 010 |
| | RS 1. 12/12 | 12 | 1/2" | 5.3 (M5) | 6.8+ | 5.0 | 0.5 | 0411 8912 012 | 0411 7712 012 |
| | RS 1. 13/12 | 13 | 1/2" | 5.3 (M5) | 6.8+ | 5.0 | 0.5 | 0411 8912 013 | 0411 7712 013 |
| | RS 1. 14/12 | 14 | 9/16" | 5.3 (M5) | 6.8+ | 5.0 | 0.5 | 0411 8912 014 | 0411 7712 014 |
| | RS 1. 15/12 | 15 | 5/8" | 5.3 (M5) | 6.8+ | 5.0 | 0.5 | 0411 8912 015 | 0411 7712 015 |
| | RS 1. 16/12 | 16 | 5/8" | 5.3 (M5) | 6.8+ | 5.0 | 0.5 | 0411 8912 016 | 0411 7712 016 |
| | RS 1. 18/12 | 18 | 3/4" | 5.3 (M5) | 6.8+ | 5.0 | 0.5 | 0411 8912 018 | 0411 7712 018 |
| | RS 1. 19/12 | 19 | 3/4" | 5.3 (M5) | 6.8+ | 5.0 | 0.5 | 0411 8912 019 | 0411 7712 019 |
| | RS 1. 20/12 | 20 | 13/16" | 5.3 (M5) | 6.8+ | 5.0 | 0.5 | 0411 8912 020 | 0411 7712 020 |
| | RS 1. 21/12 | 21 | 13/16" | 5.3 (M5) | 6.8+ | 5.0 | 0.5 | 0411 8912 021 | 0411 7712 021 |
| RS 1. 22/12 | 22 | 7/8" | 5.3 (M5) | 6.8+ | 5.0 | 0.5 | 0411 8912 022 | 0411 7712 022 | |
| 15 | RS 1. 6/15 | 6 | 1/4" | 6.4 (M6) | 9.7+ | 6.0 | 0.6 | 0411 8915 006 | 0411 7715 006 |
| | RS 1. 8/15 | 8 | 5/16" | 6.4 (M6) | 9.7+ | 6.0 | 0.6 | 0411 8915 008 | 0411 7715 008 |
| | RS 1. 10/15 | 10 | 3/8" | 6.4 (M6) | 9.7+ | 6.0 | 0.6 | 0411 8915 010 | 0411 7715 010 |
| | RS 1. 12/15 | 12 | 1/2" | 6.4 (M6) | 9.7+ | 6.0 | 0.6 | 0411 8915 012 | 0411 7715 012 |
| | RS 1. 13/15 | 13 | 1/2" | 6.4 (M6) | 9.7+ | 6.0 | 0.6 | 0411 8915 013 | 0411 7715 013 |
| | RS 1. 14/15 | 14 | 9/16" | 6.4 (M6) | 9.7+ | 6.0 | 0.8 | 0411 8915 014 | 0411 7715 014 |
| | RS 1. 15/15 | 15 | 5/8" | 6.4 (M6) | 9.7+ | 6.0 | 0.8 | 0411 8915 015 | 0411 7715 015 |
| | RS 1. 16/15 | 16 | 5/8" | 6.4 (M6) | 9.7+ | 6.0 | 0.8 | 0411 8915 016 | 0411 7715 016 |
| | RS 1. 18/15 | 18 | 3/4" | 6.4 (M6) | 9.7+ | 6.0 | 0.8 | 0411 8915 018 | 0411 7715 018 |
| | RS 1. 19/15 | 19 | 3/4" | 6.4 (M6) | 9.7+ | 6.0 | 0.8 | 0411 8915 019 | 0411 7715 019 |
| | RS 1. 20/15 | 20 | 13/16" | 6.4 (M6) | 9.7+ | 6.0 | 0.8 | 0411 8915 020 | 0411 7715 020 |
| | RS 1. 21/15 | 21 | 13/16" | 6.4 (M6) | 9.7+ | 6.0 | 0.8 | 0411 8915 021 | 0411 7715 021 |
| | RS 1. 22/15 | 22 | 7/8" | 6.4 (M6) | 9.7+ | 6.0 | 0.8 | 0411 8915 022 | 0411 7715 022 |
| | RS 1. 23/15 | 23 | 7/8" | 6.4 (M6) | 9.7+ | 6.0 | 0.8 | 0411 8915 023 | 0411 7715 023 |
| | RS 1. 25/15 | 25 | 1" | 6.4 (M6) | 9.7+ | 6.0 | 0.8 | 0411 8915 025 | 0411 7715 025 |
| | RS 1. 26/15 | 26 | 11/16" | 6.4 (M6) | 9.7+ | 6.0 | 0.8 | 0411 8915 026 | 0411 7715 026 |
| | RS 1. 28/15 | 28 | 11/8" | 6.4 (M6) | 9.7+ | 6.0 | 0.8 | 0411 8915 028 | 0411 7715 028 |
| | RS 1. 30/15 | 30 | 13/16" | 6.4 (M6) | 9.7+ | 6.0 | 0.8 | 0411 8915 030 | 0411 7715 030 |
| RS 1. 32/15 | 32 | 11/4" | 6.4 (M6) | 9.7+ | 6.0 | 0.8 | 0411 8915 032 | 0411 7715 032 | |
| RS 1. 34/15 | 34 | 15/16" | 6.4 (M6) | 9.7+ | 6.0 | 0.8 | 0411 8915 034 | 0411 7715 034 | |
| RS 1. 35/15 | 35 | 13/8" | 6.4 (M6) | 9.7+ | 6.0 | 0.8 | 0411 8915 035 | 0411 7715 035 | |
| 20 | RS 1. 10/20 | 10 | 3/8" | 8.4 (M8) | 12.5+ | 8.5 | 0.8 | 0411 8920 010 | 0411 7720 010 |
| | RS 1. 12/20 | 12 | 1/2" | 8.4 (M8) | 12.5+ | 8.5 | 0.8 | 0411 8920 012 | 0411 7720 012 |
| | RS 1. 13/20 | 13 | 1/2" | 8.4 (M8) | 12.5+ | 8.5 | 0.8 | 0411 8920 013 | 0411 7720 013 |
| | RS 1. 14/20 | 14 | 9/16" | 8.4 (M8) | 12.5+ | 8.5 | 0.8 | 0411 8920 014 | 0411 7720 014 |
| | RS 1. 15/20 | 15 | 5/8" | 8.4 (M8) | 12.5+ | 8.5 | 0.8 | 0411 8920 015 | 0411 7720 015 |
| | RS 1. 16/20 | 16 | 5/8" | 8.4 (M8) | 12.5+ | 8.5 | 0.8 | 0411 8920 016 | 0411 7720 016 |
| | RS 1. 18/20 | 18 | 3/4" | 8.4 (M8) | 12.5+ | 8.5 | 0.8 | 0411 8920 018 | 0411 7720 018 |
| | RS 1. 19/20 | 19 | 3/4" | 8.4 (M8) | 12.5+ | 8.5 | 0.8 | 0411 8920 019 | 0411 7720 019 |
| | RS 1. 20/20 | 20 | 13/16" | 8.4 (M8) | 12.5+ | 8.5 | 0.8 | 0411 8920 020 | 0411 7720 020 |
| | RS 1. 22/20 | 22 | 7/8" | 8.4 (M8) | 12.5+ | 8.5 | 0.8 | 0411 8920 022 | 0411 7720 022 |
| | RS 1. 23/20 | 23 | 7/8" | 8.4 (M8) | 12.5+ | 8.5 | 0.8 | 0411 8920 023 | 0411 7720 023 |
| | RS 1. 24/20 | 24 | 15/16" | 8.4 (M8) | 12.5+ | 8.5 | 0.8 | 0411 8920 024 | 0411 7720 024 |
| | RS 1. 25/20 | 25 | 1" | 8.4 (M8) | 12.5+ | 8.5 | 0.8 | 0411 8920 025 | 0411 7720 025 |
| | RS 1. 28/20 | 28 | 11/8" | 8.4 (M8) | 12.5+ | 8.5 | 0.8 | 0411 8920 028 | 0411 7720 028 |
| | RS 1. 30/20 | 30 | 13/16" | 8.4 (M8) | 12.5+ | 8.5 | 1.0 | 0411 8920 030 | 0411 7720 030 |
| | RS 1. 32/20 | 32 | 11/4" | 8.4 (M8) | 12.5+ | 8.5 | 1.0 | 0411 8920 032 | 0411 7720 032 |
| | RS 1. 34/20 | 34 | 15/16" | 8.4 (M8) | 12.5+ | 8.5 | 1.0 | 0411 8920 034 | 0411 7720 034 |
| | RS 1. 35/20 | 35 | 13/8" | 8.4 (M8) | 12.5+ | 8.5 | 1.0 | 0411 8920 035 | 0411 7720 035 |
| RS 1. 36/20 | 36 | 17/16" | 8.4 (M8) | 12.5+ | 8.5 | 1.0 | 0411 8920 036 | 0411 7720 036 | |
| RS 1. 38/20 | 38 | 11/2" | 8.4 (M8) | 12.5+ | 8.5 | 1.0 | 0411 8920 038 | 0411 7720 038 | |
| RS 1. 40/20 | 40 | 19/16" | 8.4 (M8) | 12.5+ | 8.5 | 1.0 | 0411 8920 040 | 0411 7720 040 | |

Band width 9 mm and 25 mm available as standard
Additional diameters available on request



RS 0



| NORMAFIX® RS 0 | | | | |
|------------------|--------------------------|------------------------------------|-----|-----|
| Band width in mm | Min. Clamping range (mm) | Thickness (mm) | | |
| | | W1 | W3 | W5 |
| 9 | 5 | 0.4 | 0.4 | 0.4 |
| 12 | 5 | 0.5 | 0.5 | 0.5 |
| 15 | 8 | ... ø 14 = 0.6 from ø 15 = 0.8 | 0.6 | 0.6 |
| 20 | 15 | ... ø 25 = 0.8 from ø 26 = 1.0 | 0.8 | 0.8 |
| 25 | 20 | ... ø 49 = 1.0 from ø 50 = 1.25 | 1.0 | 1.0 |

Available on request



Refer to page 194

RS 2



| NORMAFIX® RS 2 | | | | |
|------------------|--------------------------|------------------------------------|-----|-----|
| Band width in mm | Min. Clamping range (mm) | Thickness (mm) | | |
| | | W1 | W3 | W5 |
| 9 | 5 | 0.4 | 0.4 | 0.4 |
| 12 | 5 | 0.5 | 0.5 | 0.5 |
| 15 | 8 | ... ø 14 = 0.6 from ø 15 = 0.8 | 0.6 | 0.6 |
| 20 | 15 | ... ø 25 = 0.8 from ø 26 = 1.0 | 0.8 | 0.8 |
| 25 | 20 | ... ø 49 = 1.0 from ø 50 = 1.25 | 1.0 | 1.0 |

Available on request



Refer to page 194

RSV 1



The NORMAFIX® RSV 1 can be pre-positioned on the hose. The locking device keeps the RSV 1 safely in place if it needs to be stocked or transported prior to its final assembly.

Available in band widths of 15 and 20 mm, in the same dimensions as our RS 1. This system can only be fixed by using a special tool.

Advantages at a glance

- Safe pre-assembly on the hose
- No unintentional opening of the clamp during handling or transportation

Materials

W1, W3, W4, W5



Refer to page 194

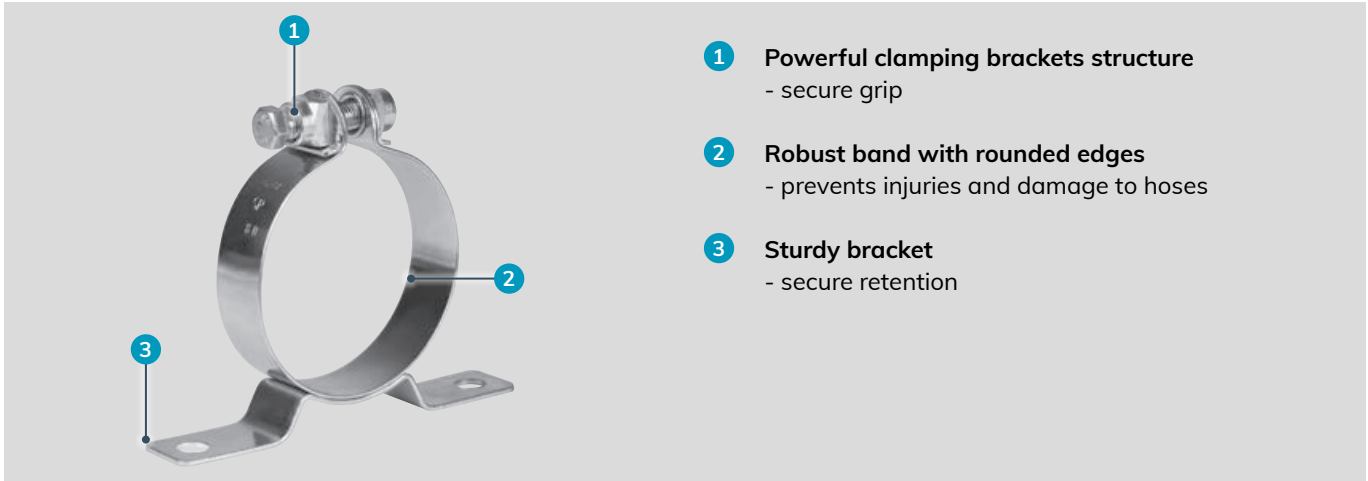

- 1 Powerful clamping brackets structure**
- secure grip
- 2 Robust band with rounded edges**
- prevents injuries and damage to hoses
- 3 Sturdy bracket**
- secure retention

Retaining clamps with brackets

NORMAFIX® HMK retaining clamps with brackets are used when high mechanical force is needed for retaining containers or pipes on ceilings and walls as well as in machine building and plant construction applications.

Standard design

This version features an “open” bracket, making it suitable for all applications in which relatively light structures are being retained and which are subject to low mechanical loads. The standard version of the retaining clamps is available in one or two parts, and with band widths of 15, 20 and 25 mm.

These clamps can be fitted with a rubber profile for shock absorption purposes. The rubber profile simultaneously protects against the ingress of creeping water.

Advantages at a glance

- ✓ For high mechanical force
- ✓ Stable construction
- ✓ Chromium (VI)-free surface

Applications

- Machine building
- Chemical industry
- Irrigation systems
- Ship manufacturing
- Food and beverage industry
- Railway industry
- Agricultural machines
- Building machines
- Engine manufacturing
- Pump and filter
- Mining industry

Materials

| | | | | |
|----|----|----|----|----|
| W1 | W2 | W3 | W4 | W5 |
| x | | | x | x |

Rubber profiles

The rubber profiles are available in EPDM (type a) and silicone (type b) material versions.

B = band width of clamp in mm
 b₁ = width in mm
 s₂ = material thickness in mm

All clamps with rubber profiles are pre-assembled. The complete clamps are supplied ready for use.

When submitting requests/orders for NORMAFIX® HMK retaining clamps with brackets, please specify which rubber profile you require.

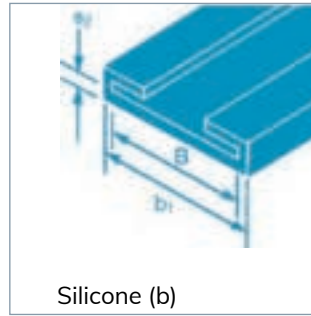

Silicone (b)

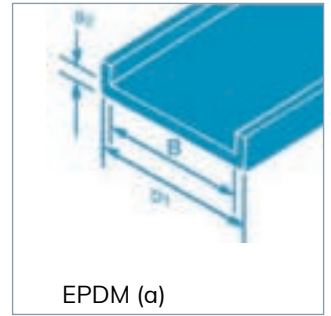

EPDM (a)

| B | b ₁ ≈ | s ₂ |
|----|------------------|----------------|
| 15 | 18.5 | 1.5 |
| 20 | 25 | 2.0 |
| 25 | 31 | 3.0 |
| 30 | 36 | 3.0 |

Technical data & Ordering information



| NORMAFIX® HMK (standard design) | | | | | | | | | | | | |
|---------------------------------|--------------------|--------------|---------------|-------|----|------------|---------|----------------|------|---------|-----|------------|
| Band width in mm | Designation | Min. ø in mm | Min. ø in in. | Bolts | | | d in mm | Rubber profile | | s in mm | | Part Group |
| | | | | Sz | Sk | Dimensions | | Silicone | EPDM | W1 | W5 | |
| 15 | HMK STANDARD 25/15 | 25 | 1 | x | | M6 x 30 | 6.5 | x | x | 0.8 | 0.6 | 1416 |
| 20 | HMK STANDARD 30/20 | 30 | 1 3/16 | x | | M8 x 40 | 8.5 | x | x | 1.0-1.5 | 0.8 | 1516 |
| 25 | HMK STANDARD 50/25 | 50 | 2 | | x | M10 x 45 | 11 | x | x | 1.5 | 1.0 | 1616 |

When submitting requests and orders, please specify the data in the following manner:

| | 1. Type | 2. Parts | 3. Diameter | 4. Band width | 5. Bolt | 6. Material |
|---------|--------------|----------|-------------|---------------|---------|-------------|
| Example | HMK STANDARD | 1616 | 80 | 25 | SK | W1 |

Single-part heavy duty



The NORMACLAMP® HMK single-part heavy duty is suitable for applications with high mechanical loads and for retaining extremely heavy pipes and connectors.

Advantages at a glance

- Stable construction
- Chromium (VI)-free surface
- EPDM Rubber profile

Materials

W1, W4

Two-parts heavy duty



In the NORMACLAMP® HMK two-parts heavy duty version, the ends of the brackets are folded back and spot-welded onto the band.

Advantages at a glance

- Stable construction
- Chromium (VI)-free surface
- EPDM Rubber profile
- Two-parts clamp for bigger clamping range
- Suitable for larger hoses

Materials

W1, W4

K1



The NORMACLAMP® HMK K1 are prefabricated brackets which you can use to transform NORMACLAMP® standard clamps (types GBS, HD, SP and TORRO) into retaining clamps with brackets in no time at all. Just open the standard clamp, guide the band through the bracket slot, and that's all there is to it.

Advantages at a glance

- Suitable for many clamp versions
- Easy to use

Material

W1

REINFORCED PIPE CLAMP / ISOPHONIC PIPE CLAMP



- 1 Secure clamping mechanism for stable grip
- 2 Rubber profile for noise and vibration insulation
- 3 Dual terminal nut suitable for both M8 and M10 screw

Two Pipe Clamp models at your choice

NORMAFIX® Reinforced Pipe Clamp / Isophonic Pipe Clamp enables pipes to be attached to walls quickly and easily.

Advantages at a glance

- ✓ Full range up to 1250 mm pipe diameter
- ✓ Captive side screws remain in place during clamp and pipe installation
- ✓ Dual terminal nut for both M8 and M10 screw
- ✓ Rubber profile for noise and vibration insulation

Applications

The NORMAFIX® Reinforced Pipe Clamp / Isophonic Pipe Clamp fixes pipes of different diameters to building structures such as walls and ceilings. The pipe clamp consists of two halves, where one half has a dual terminal nut suitable for M8 and M10 screws, for wall/ceiling mounting. The other half secures the pipe in place.

Materials

| W1 | W2 | W3 | W4 | W5 |
|----|----|----|----|----|
| x | | | x | x |

Technical data & Ordering information

| NORMAFIX® PIPE CLAMP | | | | | | |
|---------------------------|-----------|----------------------|------------|-------|-------------------------------|----------------------------|
| Designation | Ø D in mm | Clamping range in mm | Band in mm | Screw | W1 without rubber Product No. | W1 with rubber Product No. |
| PIPE CLAMP M8+M10/18 W1 | 18 | 17-20 | 20x2 | M6x16 | 0893 7111 018 | 0893 7121 018 |
| PIPE CLAMP M8+M10/22 W1 | 22 | 20-25 | 20x2 | M6x16 | 0893 7111 022 | 0893 7121 022 |
| PIPE CLAMP M8+M10/28 W1 | 28 | 26-30 | 20x2 | M6x16 | 0893 7111 028 | 0893 7121 028 |
| PIPE CLAMP M8+M10/35 W1 | 35 | 32-36 | 20x2 | M6x16 | 0893 7111 035 | 0893 7121 035 |
| PIPE CLAMP M8+M10/40 W1 | 40 | 38-45 | 20x2 | M6x16 | 0893 7111 040 | 0893 7121 040 |
| PIPE CLAMP M8+M10/48 W1 | 48 | 47-51 | 20x2 | M6x20 | 0893 7111 048 | 0893 7121 048 |
| PIPE CLAMP M8+M10/54 W1 | 54 | 53-58 | 20x2 | M6x20 | 0893 7111 054 | 0893 7121 054 |
| PIPE CLAMP M8+M10/60 W1 | 60 | 60-64 | 20x2 | M6x20 | 0893 7111 060 | 0893 7121 060 |
| PIPE CLAMP M8+M10/70 W1 | 70 | 68-72 | 20x2 | M6x20 | 0893 7111 070 | 0893 7121 070 |
| PIPE CLAMP M8+M10/75 W1 | 75 | 74-80 | 20x2 | M6x20 | 0893 7111 075 | 0893 7121 075 |
| PIPE CLAMP M8+M10/84 W1 | 84 | 81-86 | 20x2 | M6x20 | 0893 7111 084 | 0893 7121 084 |
| PIPE CLAMP M8+M10/90 W1 | 90 | 87-92 | 20x2 | M6x20 | 0893 7111 090 | 0893 7121 090 |
| PIPE CLAMP M8+M10/100 W1 | 100 | 99-105 | 20x2 | M6x20 | 0893 7111 100 | 0893 7121 100 |
| PIPE CLAMP M8+M10/110 W1 | 110 | 107-112 | 20x2 | M6x25 | 0893 7111 110 | 0893 7121 110 |
| PIPE CLAMP M8+M10/115 W1 | 115 | 113-118 | 20x2 | M6x25 | 0893 7111 115 | 0893 7121 115 |
| PIPE CLAMP M8+M10/125 W1 | 125 | 125-130 | 20x2 | M6x25 | 0893 7111 125 | 0893 7121 125 |
| PIPE CLAMP M8+M10/133 W1 | 133 | 131-137 | 20x2 | M6x25 | | 0893 7121 133 |
| PIPE CLAMP M8+M10/140 W1 | 140 | 138-142 | 20x2 | M6x25 | 0893 7111 140 | 0893 7121 140 |
| PIPE CLAMP M8+M10/150 W1 | 150 | 148-152 | 20x2 | M6x25 | 0893 7111 150 | 0893 7121 150 |
| PIPE CLAMP M8+M10/160 W1 | 160 | 159-166 | 20x2 | M6x25 | 0893 7111 160 | 0893 7121 160 |
| PIPE CLAMP M8+M10/180 W1 | 180 | 179-184 | 20x2 | M6x25 | 0893 7111 180 | 0893 7121 180 |
| PIPE CLAMP M8+M10/200 W1 | 200 | 200-205 | 28x2 | M6x25 | 0893 7111 200 | 0893 7121 200 |
| PIPE CLAMP M8+M10/220 W1 | 220 | 215-220 | 28x2 | M6x30 | 0893 7111 220 | 0893 7121 220 |
| PIPE CLAMP M8+M10/225 W1 | 225 | 223-228 | 28x2 | M6x30 | 0893 7111 225 | 0893 7121 225 |
| PIPE CLAMP M8+M10/250 W1 | 250 | 249-254 | 28x2 | M6x30 | 0893 7111 250 | 0893 7121 250 |
| PIPE CLAMP M8+M10/280 W1 | 280 | 279-284 | 28x2 | M6x30 | 0893 7111 280 | 0893 7121 280 |
| PIPE CLAMP M8+M10/300 W1 | 300 | 299-304 | 28x2 | M6x30 | 0893 7111 300 | 0893 7121 300 |
| PIPE CLAMP M8+M10/315 W1 | 315 | 314-319 | 28x2 | M6x30 | 0893 7111 315 | 0893 7121 315 |
| PIPE CLAMP M8+M10/350 W1 | 350 | 349-354 | 28x2 | M6x30 | 0893 7111 350 | 0893 7121 350 |
| PIPE CLAMP M8+M10/400 W1 | 400 | 399-406 | 28x2 | M6x30 | 0893 7111 400 | 0893 7121 400 |
| PIPE CLAMP M8+M10/450 W1 | 450 | 449-456 | 28x2 | M6x30 | 0893 7111 450 | 0893 7121 450 |
| PIPE CLAMP M8+M10/500 W1 | 500 | 499-506 | 28x2 | M6x30 | 0893 7111 500 | 0893 7121 500 |
| PIPE CLAMP M8+M10/560 W1 | 560 | 559-568 | 28x2.5 | M6x30 | 0893 7111 560 | 0893 7121 560 |
| PIPE CLAMP M8+M10/600 W1 | 600 | 599-608 | 28x2.5 | M6x30 | 0893 7111 600 | 0893 7121 600 |
| PIPE CLAMP M8+M10/630 W1 | 630 | 629-636 | 28x2.5 | M6x30 | 0893 7111 630 | 0893 7121 630 |
| PIPE CLAMP M8+M10/650 W1 | 650 | 649-656 | 28x2.5 | M6x30 | 0893 7111 650 | |
| PIPE CLAMP M8+M10/700 W1 | 700 | 699-706 | 28x2.5 | M6x30 | 0893 7111 700 | |
| PIPE CLAMP M8+M10/710 W1 | 710 | 709-716 | 28x2.5 | M6x30 | | 0893 7121 710 |
| PIPE CLAMP M8+M10/800 W1 | 800 | 799-806 | 28x2.5 | M6x30 | 0893 7111 800 | |
| PIPE CLAMP M8+M10/900 W1 | 900 | 899-906 | 28x2.5 | M6x30 | 0893 7111 900 | |
| PIPE CLAMP M8+M10/1000 W1 | 1000 | 999-1006 | 28x2.5 | M6x30 | 0893 7111 901 | |
| PIPE CLAMP M8+M10/1100 W1 | 1100 | 1099-1106 | 28x2.5 | M6x30 | 0893 7111 902 | |
| PIPE CLAMP M8+M10/1200 W1 | 1200 | 1199-1206 | 28x2.5 | M6x30 | 0893 7111 903 | |
| PIPE CLAMP M8+M10/1250 W1 | 1250 | 1249-1256 | 28x2.5 | M6x30 | 0893 7111 904 | |

REINFORCED PIPE CLAMP / ISOPHONIC PIPE CLAMP

| NORMAFIX® PIPE CLAMP | | | | | | |
|--------------------------|--------------|-------------------------|---------------|-------|----------------------------------|-------------------------------|
| Designation | Ø D in mm | Clamping range in mm | Band in mm | Screw | W4 without rubber Product No. | W4 with rubber Product No. |
| PIPE CLAMP M8+M10/18 W4 | 18 | 16-20 | 20x2 | M6x16 | 0893 7114 018 | 0893 7124 018 |
| PIPE CLAMP M8+M10/22 W4 | 22 | 21-26 | 20x2 | M6x16 | 0893 7114 022 | 0893 7124 022 |
| PIPE CLAMP M8+M10/28 W4 | 28 | 26-31 | 20x2 | M6x16 | 0893 7114 028 | 0893 7124 028 |
| PIPE CLAMP M8+M10/35 W4 | 35 | 33-38 | 20x2 | M6x16 | 0893 7114 035 | 0893 7124 035 |
| PIPE CLAMP M8+M10/40 W4 | 40 | 40-45 | 20x2 | M6x16 | 0893 7114 040 | 0893 7124 040 |
| PIPE CLAMP M8+M10/48 W4 | 48 | 47-52 | 20x2 | M6x20 | 0893 7114 048 | 0893 7124 048 |
| PIPE CLAMP M8+M10/54 W4 | 54 | 52-57 | 20x2 | M6x20 | 0893 7114 054 | 0893 7124 054 |
| PIPE CLAMP M8+M10/60 W4 | 60 | 60-65 | 20x2 | M6x20 | 0893 7114 060 | 0893 7124 060 |
| PIPE CLAMP M8+M10/70 W4 | 70 | 68-72 | 20x2 | M6x20 | 0893 7114 070 | 0893 7121 070 |
| PIPE CLAMP M8+M10/75 W4 | 75 | 72-77 | 20x2 | M6x20 | 0893 7114 075 | 0893 7124 075 |
| PIPE CLAMP M8+M10/84 W4 | 84 | 81-86 | 20x2 | M6x20 | 0893 7114 084 | 0893 7124 084 |
| PIPE CLAMP M8+M10/90 W4 | 90 | 87-94 | 20x2 | M6x20 | 0893 7114 090 | 0893 7124 090 |
| PIPE CLAMP M8+M10/104 W4 | 104 | 98-105 | 20x2 | M6x20 | 0893 7114 104 | 0893 7124 100 |
| PIPE CLAMP M8+M10/110 W4 | 110 | 107-114 | 20x2 | M6x25 | 0893 7114 110 | 0893 7124 110 |
| PIPE CLAMP M8+M10/115 W4 | 115 | 111-118 | 20x2 | M6x25 | 0893 7114 115 | 0893 7124 115 |
| PIPE CLAMP M8+M10/125 W4 | 125 | 121-128 | 20x2 | M6x25 | 0893 7114 125 | 0893 7124 125 |
| PIPE CLAMP M8+M10/133 W4 | 133 | 132-137 | 20x2 | M6x25 | 0893 7114 133 | 0893 7124 133 |
| PIPE CLAMP M8+M10/140 W4 | 140 | 133-140 | 20x2 | M6x25 | 0893 7114 140 | 0893 7124 140 |
| PIPE CLAMP M8+M10/150 W4 | 150 | 147-155 | 20x2 | M6x25 | 0893 7114 150 | 0893 7124 150 |
| PIPE CLAMP M8+M10/160 W4 | 160 | 158-170 | 20x2 | M6x25 | 0893 7114 160 | 0893 7124 160 |
| PIPE CLAMP M8+M10/180 W4 | 180 | 177-184 | 20x2 | M6x25 | 0893 7114 180 | 0893 7124 180 |
| PIPE CLAMP M8+M10/204 W4 | 204 | 198-210 | 28x2 | M6x25 | 0893 7114 204 | 0893 7124 204 |
| PIPE CLAMP M8+M10/220 W4 | 220 | 215-220 | 28x2 | M6x30 | 0893 7114 220 | 0893 7124 220 |
| PIPE CLAMP M8+M10/225 W4 | 225 | 223-228 | 28x2 | M6x30 | 0893 7114 225 | 0893 7124 225 |
| PIPE CLAMP M8+M10/250 W4 | 250 | 249-254 | 28x2 | M6x30 | 0893 7114 250 | 0893 7124 250 |
| PIPE CLAMP M8+M10/280 W4 | 280 | 279-284 | 28x2 | M6x30 | 0893 7114 280 | 0893 7124 280 |
| PIPE CLAMP M8+M10/300 W4 | 300 | 299-304 | 28x2 | M6x30 | 0893 7114 300 | 0893 7124 300 |
| PIPE CLAMP M8+M10/315 W4 | 315 | 314-319 | 28x2 | M6x30 | 0893 7114 315 | 0893 7124 315 |
| PIPE CLAMP M8+M10/350 W4 | 350 | 354-359 | 28x2 | M6x30 | 0893 7114 350 | 0893 7124 350 |
| PIPE CLAMP M8+M10/400 W4 | 400 | 399-406 | 28x2 | M6x30 | 0893 7114 400 | |
| PIPE CLAMP M8+M10/500 W4 | 500 | 499-506 | 28x2 | M6x30 | 0893 7114 500 | |

REINFORCED PIPE CLAMP / ISOPHONIC PIPE CLAMP

| NORMAFIX® PIPE CLAMP | | | | | | |
|--------------------------|--------------|-------------------------|---------------|-------|----------------------------------|-------------------------------|
| Designation | Ø D in mm | Clamping range in mm | Band in mm | Screw | W5 without rubber Product No. | W5 with rubber Product No. |
| PIPE CLAMP M8+M10/18 W5 | 18 | 16-20 | 20x2 | M6x16 | 0893 7115 018 | 0893 7125 018 |
| PIPE CLAMP M8+M10/22 W5 | 22 | 21-26 | 20x2 | M6x16 | 0893 7115 022 | 0893 7125 022 |
| PIPE CLAMP M8+M10/28 W5 | 28 | 26-31 | 20x2 | M6x16 | 0893 7115 028 | 0893 7125 028 |
| PIPE CLAMP M8+M10/35 W5 | 35 | 33-38 | 20x2 | M6x16 | 0893 7115 035 | 0893 7125 035 |
| PIPE CLAMP M8+M10/40 W5 | 40 | 40-45 | 20x2 | M6x16 | 0893 7115 040 | 0893 7125 040 |
| PIPE CLAMP M8+M10/48 W5 | 48 | 47-52 | 20x2 | M6x20 | 0893 7115 048 | 0893 7125 048 |
| PIPE CLAMP M8+M10/54 W5 | 54 | 52-57 | 20x2 | M6x20 | 0893 7115 054 | 0893 7125 054 |
| PIPE CLAMP M8+M10/60 W5 | 60 | 60-65 | 20x2 | M6x20 | 0893 7115 060 | 0893 7125 060 |
| PIPE CLAMP M8+M10/70 W5 | 70 | 68-72 | 20x2 | M6x20 | 0893 7115 070 | 0893 7121 070 |
| PIPE CLAMP M8+M10/75 W5 | 75 | 72-77 | 20x2 | M6x20 | 0893 7115 075 | 0893 7125 075 |
| PIPE CLAMP M8+M10/84 W5 | 84 | 81-86 | 20x2 | M6x20 | 0893 7115 084 | 0893 7125 084 |
| PIPE CLAMP M8+M10/90 W5 | 90 | 87-94 | 20x2 | M6x20 | 0893 7115 090 | 0893 7125 090 |
| PIPE CLAMP M8+M10/100 W5 | 104 | 98-105 | 20x2 | M6x20 | 0893 7115 100 | 0893 7125 100 |
| PIPE CLAMP M8+M10/110 W5 | 110 | 107-114 | 20x2 | M6x25 | 0893 7115 110 | 0893 7125 110 |
| PIPE CLAMP M8+M10/115 W5 | 115 | 111-118 | 20x2 | M6x25 | 0893 7115 115 | 0893 7125 115 |
| PIPE CLAMP M8+M10/125 W5 | 125 | 121-128 | 20x2 | M6x25 | 0893 7115 125 | 0893 7125 125 |
| PIPE CLAMP M8+M10/133 W5 | 133 | 132-137 | 20x2 | M6x25 | 0893 7115 133 | 0893 7125 133 |
| PIPE CLAMP M8+M10/140 W5 | 140 | 133-140 | 20x2 | M6x25 | 0893 7115 140 | 0893 7125 140 |
| PIPE CLAMP M8+M10/150 W5 | 150 | 147-155 | 20x2 | M6x25 | 0893 7115 150 | 0893 7125 150 |
| PIPE CLAMP M8+M10/160 W5 | 160 | 158-170 | 20x2 | M6x25 | 0893 7115 160 | 0893 7125 160 |
| PIPE CLAMP M8+M10/180 W5 | 180 | 177-184 | 20x2 | M6x25 | 0893 7115 180 | 0893 7125 180 |
| PIPE CLAMP M8+M10/204 W5 | 204 | 198-210 | 28x2 | M6x25 | 0893 7115 204 | 0893 7125 204 |
| PIPE CLAMP M8+M10/220 W5 | 220 | 215-220 | 28x2 | M6x30 | 0893 7115 220 | 0893 7125 220 |
| PIPE CLAMP M8+M10/225 W5 | 225 | 223-228 | 28x2 | M6x30 | 0893 7115 225 | 0893 7125 225 |
| PIPE CLAMP M8+M10/250 W5 | 250 | 249-254 | 28x2 | M6x30 | 0893 7115 250 | 0893 7125 250 |
| PIPE CLAMP M8+M10/280 W5 | 280 | 279-284 | 28x2 | M6x30 | 0893 7115 280 | 0893 7125 280 |
| PIPE CLAMP M8+M10/300 W5 | 300 | 299-304 | 28x2 | M6x30 | 0893 7115 300 | 0893 7125 300 |
| PIPE CLAMP M8+M10/315 W5 | 315 | 314-319 | 28x2 | M6x30 | 0893 7115 315 | 0893 7125 315 |
| PIPE CLAMP M8+M10/350 W5 | 350 | 354-359 | 28x2 | M6x30 | 0893 7115 350 | 0893 7125 350 |
| PIPE CLAMP M8+M10/400 W5 | 400 | 399-406 | 28x2 | M6x30 | 0893 7115 400 | |
| PIPE CLAMP M8+M10/500 W5 | 500 | 499-506 | 28x2 | M6x30 | 0893 7115 500 | |

U-BOLT CLAMP

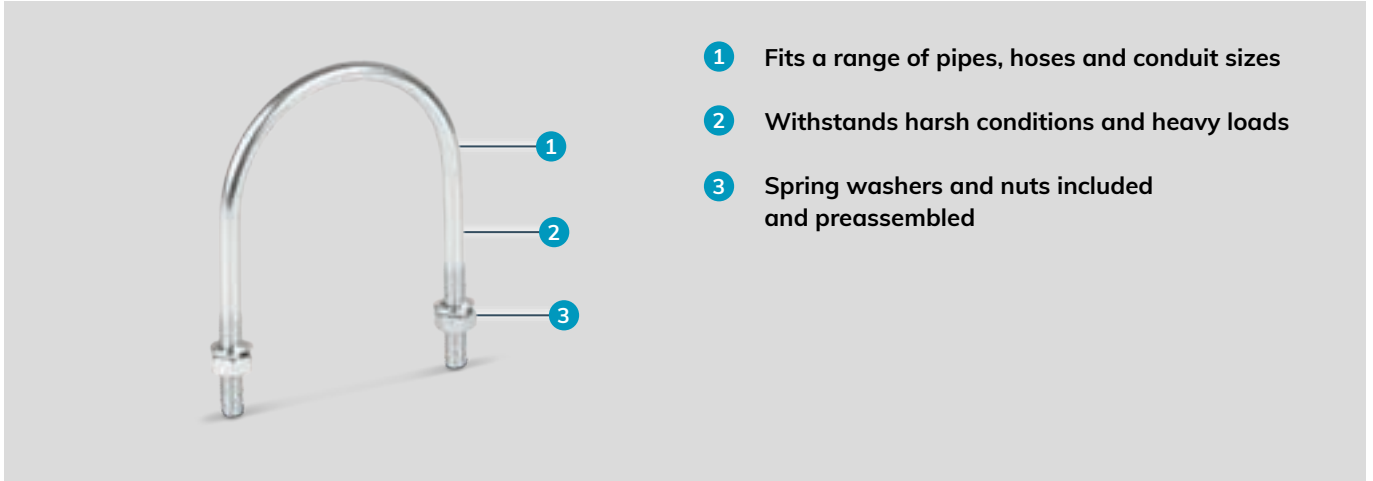

Keep simple things simple series

The NORMAFIX® U-Bolt Clamps are U shaped, bent bolts with threads at both ends. A wide clamping range from 18 mm-350 mm is available. It is available both with carbon steel and stainless steel materials (AISI 304, AISI 316).

Advantages at a glance

- ✓ Spring washers and nuts included
- ✓ Available in carbon steel and stainless steel
- ✓ Ready to install with improved locking capabilities
- ✓ Suitable for inside and outside installations

Applications

The NORMAFIX® U-Bolt Clamp has a vast range of applications. For example, it is used in buildings, constructions and as an anchor for foundations, roofs, pipes and conduit holders.

Materials

| W1 | W2 | W3 | W4 | W5 |
|----|----|----|----|----|
| x | | | x | x |

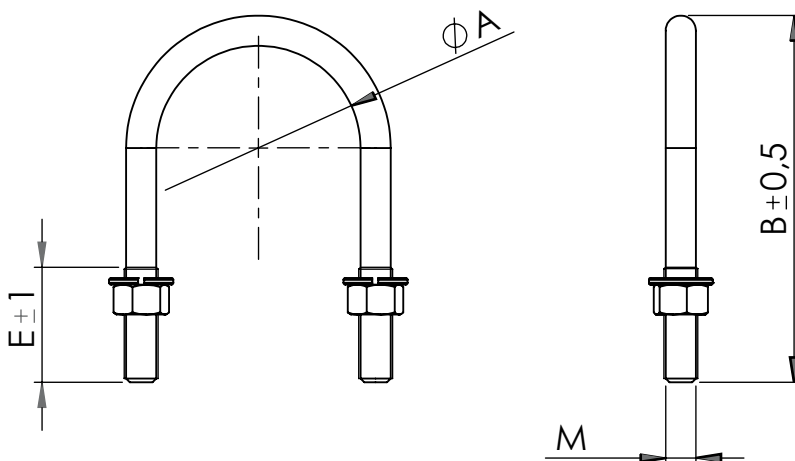

Technical data & Ordering information

| NORMAFIX® U-BOLT CLAMP | | | | | | | |
|------------------------|----------|----------|--------|-----|-------------------|-------------------|-------------------|
| Designation | Measures | | | | W1 Product No. | W4 Product No. | W5 Product No. |
| | Ø (A) mm | (mm) (B) | (mm) E | M | | | |
| U-BOLT CLAMP 18 | 18 | 50 | 35 | M6 | 0893 7211 018 | 0893 7214 018 | 0893 7215 018 |
| U-BOLT CLAMP 22 | 22 | 53 | 35 | M6 | 0893 7211 022 | 0893 7214 022 | 0893 7215 022 |
| U-BOLT CLAMP 28 | 28 | 59 | 35 | M6 | 0893 7211 028 | 0893 7214 028 | 0893 7215 028 |
| U-BOLT CLAMP 34 | 34 | 65 | 35 | M6 | 0893 7211 034 | 0893 7214 034 | 0893 7215 034 |
| U-BOLT CLAMP 39 | 39 | 70 | 35 | M6 | 0893 7211 039 | 0893 7214 039 | 0893 7215 039 |
| U-BOLT CLAMP 43 | 43 | 74 | 35 | M6 | 0893 7211 043 | 0893 7214 043 | 0893 7215 043 |
| U-BOLT CLAMP 49 | 49 | 85 | 40 | M8 | 0893 7211 049 | 0893 7214 049 | 0893 7215 049 |
| U-BOLT CLAMP 54 | 54 | 96 | 40 | M8 | 0893 7211 054 | 0893 7214 054 | 0893 7215 054 |
| U-BOLT CLAMP 55 | 55 | 97 | 40 | M8 | 0893 7211 055 | 0893 7214 055 | 0893 7215 055 |
| U-BOLT CLAMP 61 | 61 | 99 | 40 | M8 | 0893 7211 061 | 0893 7214 061 | 0893 7215 061 |
| U-BOLT CLAMP 66 | 66 | 98 | 40 | M8 | 0893 7211 066 | 0893 7214 066 | 0893 7215 066 |
| U-BOLT CLAMP 71 | 71 | 102 | 40 | M8 | 0893 7211 071 | 0893 7214 071 | 0893 7215 071 |
| U-BOLT CLAMP 77 | 77 | 113 | 40 | M8 | 0893 7211 077 | 0893 7214 077 | 0893 7215 077 |
| U-BOLT CLAMP 85 | 85 | 117 | 40 | M8 | 0893 7211 085 | 0893 7214 085 | 0893 7215 085 |
| U-BOLT CLAMP 90 | 90 | 126 | 40 | M8 | 0893 7211 090 | 0893 7214 090 | 0893 7215 090 |
| U-BOLT CLAMP 105 | 105 | 149 | 40 | M10 | 0893 7211 105 | 0893 7214 105 | 0893 7215 105 |
| U-BOLT CLAMP 115 | 115 | 155 | 40 | M10 | 0893 7211 115 | 0893 7214 115 | 0893 7215 115 |
| U-BOLT CLAMP 130 | 130 | 170 | 40 | M10 | 0893 7211 130 | 0893 7214 130 | 0893 7215 130 |
| U-BOLT CLAMP 144 | 144 | 184 | 40 | M10 | 0893 7211 144 | 0893 7214 144 | 0893 7215 144 |
| U-BOLT CLAMP 155 | 155 | 194 | 40 | M10 | 0893 7211 155 | 0893 7214 155 | 0893 7215 155 |
| U-BOLT CLAMP 170 | 170 | 210 | 40 | M10 | 0893 7211 170 | 0893 7214 170 | 0893 7215 170 |
| U-BOLT CLAMP 206 | 206 | 244 | 40 | M10 | 0893 7211 206 | 0893 7214 206 | 0893 7215 206 |
| U-BOLT CLAMP 221 | 221 | 259 | 40 | M10 | 0893 7211 221 | 0893 7214 221 | 0893 7215 221 |
| U-BOLT CLAMP 256 | 256 | 294 | 40 | M10 | 0893 7211 256 | 0893 7214 256 | 0893 7215 256 |
| U-BOLT CLAMP 275 | 275 | 313 | 40 | M10 | 0893 7211 275 | 0893 7214 275 | 0893 7215 275 |
| U-BOLT CLAMP 306 | 306 | 344 | 50 | M10 | 0893 7211 306 | 0893 7214 306 | 0893 7215 306 |
| U-BOLT CLAMP 324 | 324 | 368 | 50 | M10 | 0893 7211 324 | 0893 7214 324 | 0893 7215 324 |
| U-BOLT CLAMP 354 | 354 | 407 | 50 | M10 | 0893 7211 354 | 0893 7214 354 | 0893 7215 354 |

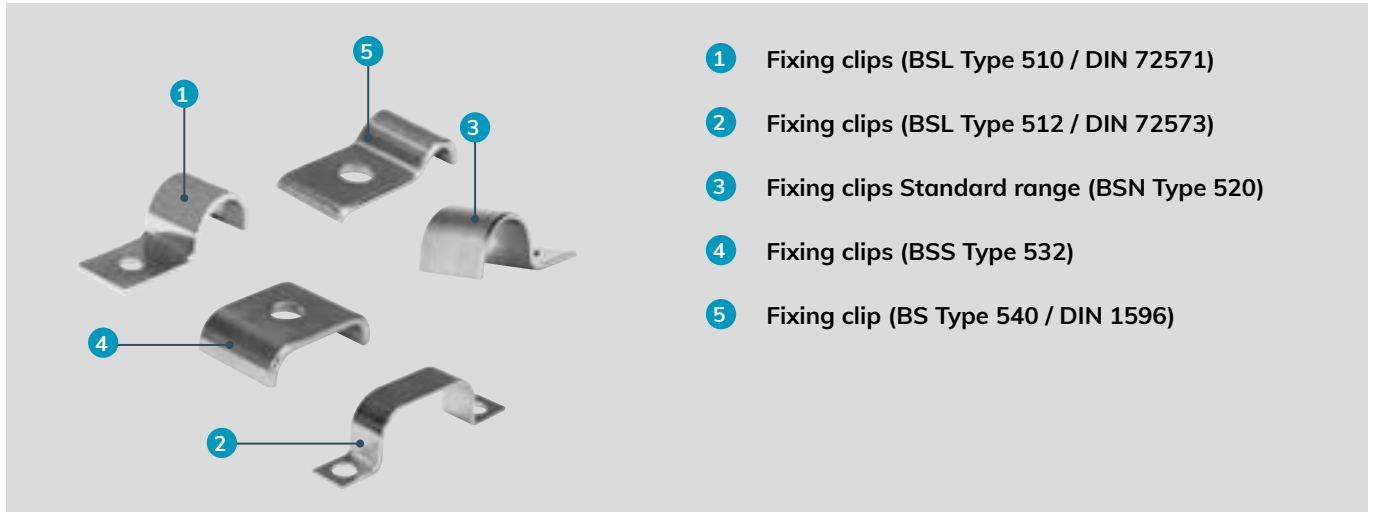

- 1 Fixing clips (BSL Type 510 / DIN 72571)
- 2 Fixing clips (BSL Type 512 / DIN 72573)
- 3 Fixing clips Standard range (BSN Type 520)
- 4 Fixing clips (BSS Type 532)
- 5 Fixing clip (BS Type 540 / DIN 1596)

Fixing clips

NORMAFIX® BSL / BSN / BSS / BS fixing clips enable pipes, cables and cable protection pipes to be attached to structures quickly and easily. They are suitable for all industrial Anwendungen which require a low-priced yet reliable attachment solution.

Vorteile auf einen Blick

- ✓ Sturdy band design and precise fit
- ✓ Components are retained securely and with ease
- ✓ Band Bandbreite from 4 to 61 mm depending on the version
- ✓ Material Stärke from 1 to 4 mm depending on the version
- ✓ Multiple versions for different Anwendungen

Werkstoffe

| W1 | W2 | W3 | W4 | W5 |
|----|----|----|----|----|
| x | | | | |

BSL type 510 for 1 line

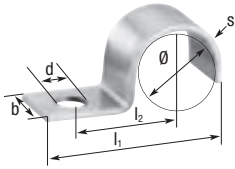

| NORMAFIX® BSL TYPE 510 FOR 1 LINE (in accordance with DIN 72571) | | | | | | | | |
|--|----------------|-----------------|-----------|-------------------------|-------------------------|----------------------|---------------------------|-------------------|
| Width b in mm | Designation | Clamping ranges | | l ₁ in mm | l ₂ in mm | Bore hole in mm d | Mat. thickness in mm s | W1 Product No. |
| | | in mm | in inches | | | | | |
| 10 | BSL 510 1 x 4 | 4 | 3/16" | 18 | 9 | 4.8 | 1 | 0510 8980 104 |
| | BSL 510 1 x 5 | 5 | 3/16" | 18.5 | 9 | 4.8 | 1 | 0510 8980 105 |
| | BSL 510 1 x 6 | 6 | 1/4" | 20 | 10 | 4.8 | 1 | 0510 8980 106 |
| | BSL 510 1 x 7 | 7 | 1/4" | 20.5 | 10 | 4.8 | 1 | 0510 8980 107 |
| | BSL 510 1 x 8 | 8 | 5/16" | 22 | 11 | 4.8 | 1 | 0510 8980 108 |
| | BSL 510 1 x 9 | 9 | 3/8" | 22.5 | 11 | 4.8 | 1 | 0510 8980 109 |
| 12 | BSL 510 1 x 10 | 10 | 3/8" | 23 | 11 | 4.8 | 1 | 0510 8980 110 |
| | BSL 510 1 x 11 | 11 | 7/16" | 30 | 15 | 5.8 | 1.5 | 0510 8980 111 |
| | BSL 510 1 x 12 | 12 | 1/2" | 30.5 | 16 | 5.8 | 1.5 | 0510 8980 112 |
| | BSL 510 1 x 15 | 15 | 9/16" | 34 | 18 | 5.8 | 1.5 | 0510 8980 115 |
| | BSL 510 1 x 16 | 16 | 5/8" | 35 | 18 | 5.8 | 1.5 | 0510 8980 116 |
| | BSL 510 1 x 18 | 18 | 11/16" | 35.5 | 18 | 7 | 1.5 | 0510 8980 118 |
| | BSL 510 1 x 20 | 20 | 13/16" | 37.5 | 19 | 7 | 1.5 | 0510 8980 120 |
| | BSL 510 1 x 22 | 22 | 7/8" | 39.5 | 20 | 7 | 1.5 | 0510 8980 122 |
| BSL 510 1 x 24 | 24 | 15/16" | 41.5 | 21 | 7 | 1.5 | 0510 8980 124 | |

BSL type 510 for 2 lines

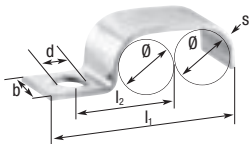

| NORMAFIX® BSL TYPE 510 FOR 2 LINES (in accordance with DIN 72571) | | | | | | | | |
|---|----------------|-----------------|-----------|-------------------------|-------------------------|----------------------|---------------------------|-------------------|
| Width b in mm | Designation | Clamping ranges | | l ₁ in mm | l ₂ in mm | Bore hole in mm d | Mat. thickness in mm s | W1 Product No. |
| | | in mm | in inches | | | | | |
| 10 | BSL 510 2 x 4 | 4 | 3/16" | 22.5 | 11 | 4.8 | 1 | 0510 8980 204 |
| | BSL 510 2 x 5 | 5 | 3/16" | 24 | 11.5 | 4.8 | 1 | 0510 8980 205 |
| | BSL 510 2 x 6 | 6 | 1/4" | 26.5 | 13 | 4.8 | 1 | 0510 8980 206 |
| | BSL 510 2 x 7 | 7 | 1/4" | 28 | 13.5 | 4.8 | 1 | 0510 8980 207 |
| | BSL 510 2 x 8 | 8 | 5/16" | 30.5 | 15 | 4.8 | 1 | 0510 8980 208 |
| | BSL 510 2 x 10 | 10 | 3/8" | 33.5 | 16 | 4.8 | 1 | 0510 8980 210 |
| 12 | BSL 510 2 x 12 | 12 | 1/2" | 43 | 22 | 5.8 | 1.5 | 0510 8980 212 |
| | BSL 510 2 x 15 | 15 | 9/16" | 49 | 25.3 | 5.8 | 1.5 | 0510 8980 215 |

BSL type 512 for 1 line

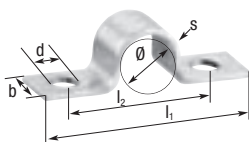

| NORMAFIX® BSL TYPE 512 FOR 1 LINE (in accordance with DIN 72573) | | | | | | | | |
|--|----------------|-----------------|-----------|-------------------------|-------------------------|----------------------|---------------------------|-------------------|
| Width b in mm | Designation | Clamping ranges | | l ₁ in mm | l ₂ in mm | Bore hole in mm d | Mat. thickness in mm s | W1 Product No. |
| | | in mm | in inches | | | | | |
| 10 | BSL 512 1 x 4 | 4 | 3/16" | 29 | 17 | 4.8 | 1 | 0512 8980 104 |
| | BSL 512 1 x 5 | 5 | 3/16" | 30 | 18 | 4.8 | 1 | 0512 8980 105 |
| | BSL 512 1 x 6 | 6 | 1/4" | 32 | 20 | 4.8 | 1 | 0512 8980 106 |
| | BSL 512 1 x 7 | 7 | 1/4" | 32 | 20 | 4.8 | 1 | 0512 8980 107 |
| | BSL 512 1 x 8 | 8 | 5/16" | 34 | 22 | 4.8 | 1 | 0512 8980 108 |
| | BSL 512 1 x 10 | 10 | 3/8" | 34 | 22 | 4.8 | 1 | 0512 8980 110 |
| 12 | BSL 512 1 x 12 | 12 | 1/2" | 46 | 32 | 5.8 | 1.5 | 0512 8980 112 |
| | BSL 512 1 x 15 | 15 | 9/16" | 50 | 36 | 5.8 | 1.5 | 0512 8980 115 |
| | BSL 512 1 x 18 | 18 | 11/16" | 50 | 36 | 7 | 1.5 | 0512 8980 118 |
| | BSL 512 1 x 20 | 20 | 13/16" | 52 | 38 | 7 | 1.5 | 0512 8980 120 |
| | BSL 512 1 x 22 | 22 | 7/8" | 54 | 40 | 7 | 1.5 | 0512 8980 122 |

BSL – VERSIONS

BSL type 512 for 2 lines

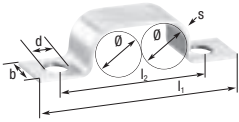

| NORMAFIX® BSL TYPE 512 FOR 2 LINES (in accordance with DIN 72573) | | | | | | | | |
|---|----------------|-----------------|-----------|-------------------------|-------------------------|----------------------|---------------------------|-------------------|
| Width b in mm | Designation | Clamping ranges | | l ₁ in mm | l ₂ in mm | Bore hole in mm d | Mat. thickness in mm s | W1 Product No. |
| | | in mm | in inches | | | | | |
| 10 | BSL 512 2 x 4 | 4 | 3/16" | 33 | 21 | 4.8 | 1 | 0512 8980 204 |
| | BSL 512 2 x 5 | 5 | 3/16" | 35 | 23 | 4.8 | 1 | 0512 8980 205 |
| | BSL 512 2 x 6 | 6 | 1/4" | 38 | 26 | 4.8 | 1 | 0512 8980 206 |
| | BSL 512 2 x 7 | 7 | 1/4" | 39 | 27 | 4.8 | 1 | 0512 8980 207 |
| | BSL 512 2 x 8 | 8 | 5/16" | 42 | 30 | 4.8 | 1 | 0512 8980 208 |
| | BSL 512 2 x 10 | 10 | 3/8" | 44 | 32 | 4.8 | 1 | 0512 8980 210 |
| 12 | BSL 512 2 x 12 | 12 | 1/2" | 58 | 44 | 5.8 | 1.5 | 0512 8980 212 |
| | BSL 512 2 x 15 | 15 | 9/16" | 66 | 52 | 5.8 | 1.5 | 0512 8980 215 |
| | BSL 512 2 x 18 | 18 | 11/16" | 69 | 55 | 7 | 1.5 | 0512 8980 218 |
| | BSL 512 2 x 20 | 20 | 13/16" | 73 | 59 | 7 | 1.5 | 0512 8980 220 |
| | BSL 512 2 x 22 | 22 | 7/8" | 77 | 63 | 7 | 1.5 | 0512 8980 222 |

BSL type 512 for 3 lines

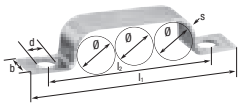

| NORMAFIX® BSL TYPE 512 FOR 3 LINES (in accordance with DIN 72573) | | | | | | | | |
|---|----------------|-----------------|-----------|-------------------------|-------------------------|----------------------|---------------------------|-------------------|
| Width b in mm | Designation | Clamping ranges | | l ₁ in mm | l ₂ in mm | Bore hole in mm d | Mat. thickness in mm s | W1 Product No. |
| | | in mm | in inches | | | | | |
| 10 | BSL 512 3 x 4 | 4 | 3/16" | 39 | 27 | 4.8 | 1 | 0512 8980 304 |
| | BSL 512 3 x 5 | 5 | 3/16" | 41 | 29 | 4.8 | 1 | 0512 8980 305 |
| | BSL 512 3 x 6 | 6 | 1/4" | 45 | 33 | 4.8 | 1 | 0512 8980 306 |
| | BSL 512 3 x 7 | 7 | 1/4" | 47 | 35 | 4.8 | 1 | 0512 8980 307 |
| | BSL 512 3 x 8 | 8 | 5/16" | 51 | 39 | 4.8 | 1 | 0512 8980 308 |
| | BSL 512 3 x 10 | 10 | 3/8" | 55 | 43 | 4.8 | 1 | 0512 8980 310 |
| 12 | BSL 512 3 x 12 | 12 | 1/2" | 71 | 57 | 5.8 | 1.5 | 0512 8980 312 |
| | BSL 512 3 x 15 | 15 | 9/16" | 81 | 67 | 5.8 | 1.5 | 0512 8980 315 |
| | BSL 512 3 x 18 | 18 | 11/16" | 87 | 73 | 7 | 1.5 | 0512 8980 318 |
| | BSL 512 3 x 20 | 20 | 13/16" | 93 | 79 | 7 | 1.5 | 0512 8980 320 |
| | BSL 512 3 x 22 | 22 | 7/8" | 99 | 85 | 7 | 1.5 | 0512 8980 322 |

BSL type 512 for 4 lines

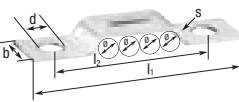

| NORMAFIX® BSL TYPE 512 FOR 4 LINES (in accordance with DIN 72573) | | | | | | | | |
|---|----------------|-----------------|-----------|-------------------------|-------------------------|----------------------|---------------------------|-------------------|
| Width b in mm | Designation | Clamping ranges | | l ₁ in mm | l ₂ in mm | Bore hole in mm d | Mat. thickness in mm s | W1 Product No. |
| | | in mm | in inches | | | | | |
| 10 | BSL 512 4 x 4 | 4 | 3/16" | 29 | 17 | 4.8 | 1 | 0512 8980 404 |
| | BSL 512 4 x 5 | 5 | 3/16" | 30 | 18 | 4.8 | 1 | 0512 8980 405 |
| | BSL 512 4 x 6 | 6 | 1/4" | 32 | 20 | 4.8 | 1 | 0512 8980 406 |
| | BSL 512 4 x 7 | 7 | 1/4" | 32 | 20 | 4.8 | 1 | 0512 8980 407 |
| | BSL 512 4 x 8 | 8 | 5/16" | 34 | 22 | 4.8 | 1 | 0512 8980 408 |
| | BSL 512 4 x 10 | 10 | 3/8" | 34 | 22 | 4.8 | 1 | 0512 8980 410 |
| 12 | BSL 512 4 x 12 | 12 | 1/2" | 46 | 32 | 5.8 | 1.5 | 0512 8980 412 |
| | BSL 512 4 x 15 | 15 | 9/16" | 50 | 36 | 5.8 | 1.5 | 0512 8980 415 |
| | BSL 512 4 x 18 | 18 | 11/16" | 50 | 36 | 7 | 1.5 | 0512 8980 418 |
| | BSL 512 4 x 20 | 20 | 13/16" | 52 | 38 | 7 | 1.5 | 0512 8980 420 |
| | BSL 512 4 x 22 | 22 | 7/8" | 54 | 40 | 7 | 1.5 | 0512 8980 422 |

BSL type 512 for 5 lines



| NORMAFIX® BSL TYPE 512 FOR 5 LINES (in accordance with DIN 72573) | | | | | | | | |
|---|----------------|-----------------|-----------|-------------------------|-------------------------|----------------------|---------------------------|-------------------|
| Width b in mm | Designation | Clamping ranges | | l ₁ in mm | l ₂ in mm | Bore hole in mm d | Mat. thickness in mm s | W1 Product No. |
| | | in mm | in inches | | | | | |
| 10 | BSL 512 5 x 4 | 4 | 3/16" | 48 | 36 | 4.8 | 1 | 0512 8980 504 |
| | BSL 512 5 x 5 | 5 | 3/16" | 53 | 41 | 4.8 | 1 | 0512 8980 505 |
| | BSL 512 5 x 6 | 6 | 1/4" | 57 | 45 | 4.8 | 1 | 0512 8980 506 |
| | BSL 512 5 x 7 | 7 | 1/4" | 63 | 51 | 4.8 | 1 | 0512 8980 507 |
| | BSL 512 5 x 8 | 8 | 5/16" | 68 | 56 | 4.8 | 1 | 0512 8980 508 |
| | BSL 512 5 x 10 | 10 | 3/8" | 77 | 65 | 4.8 | 1 | 0512 8980 510 |
| 12 | BSL 512 5 x 12 | 12 | 1/2" | 95 | 81 | 5.8 | 1.5 | 0512 8980 512 |

BSL type 512 for 6 lines

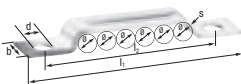

| NORMAFIX® BSL TYPE 512 FOR 6 LINES (in accordance with DIN 72573) | | | | | | | | |
|---|----------------|-----------------|-----------|-------------------------|-------------------------|----------------------|---------------------------|-------------------|
| Width b in mm | Designation | Clamping ranges | | l ₁ in mm | l ₂ in mm | Bore hole in mm d | Mat. thickness in mm s | W1 Product No. |
| | | in mm | in inches | | | | | |
| 10 | BSL 512 6 x 4 | 4 | 3/16" | 52 | 40 | 4.8 | 1 | 0512 8980 604 |
| | BSL 512 6 x 5 | 5 | 3/16" | 58 | 46 | 4.8 | 1 | 0512 8980 605 |
| | BSL 512 6 x 6 | 6 | 1/4" | 64 | 52 | 4.8 | 1 | 0512 8980 606 |
| | BSL 512 6 x 7 | 7 | 1/4" | 72 | 60 | 4.8 | 1 | 0512 8980 607 |
| | BSL 512 6 x 8 | 8 | 5/16" | 76 | 64 | 4.8 | 1 | 0512 8980 608 |
| | BSL 512 6 x 10 | 10 | 3/8" | 90 | 78 | 4.8 | 1 | 0512 8980 610 |

BSN – VERSIONS

BSN type 520 for 1 line

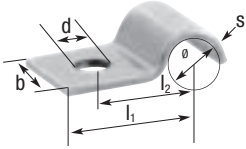

| NORMAFIX® BSN TYPE 520 FOR 1 LINE | | | | | | | | |
|-----------------------------------|----------------|-----------------|-----------|-------------------------|-------------------------|----------------------|---------------------------|-------------------|
| Width b in mm | Designation | Clamping ranges | | l ₁ in mm | l ₂ in mm | Bore hole in mm d | Mat. thickness in mm s | W1 Product No. |
| | | in mm | in inches | | | | | |
| 20 | BSN 520 1 x 8 | 8 | 5/16" | 26 | 16.5 | 7 | 2 | 0520 7000 008 |
| | BSN 520 1 x 9 | 9 | 3/8" | 26.5 | 17 | 7 | 2 | 0520 7000 009 |
| | BSN 520 1 x 10 | 10 | 3/8" | 26.5 | 17 | 7 | 2 | 0520 7000 010 |
| | BSN 520 1 x 12 | 12 | 1/2" | 28 | 18 | 7 | 2 | 0520 7000 012 |
| | BSN 520 1 x 13 | 13 | 1/2" | 28.5 | 19 | 7 | 2 | 0520 7000 013 |
| | BSN 520 1 x 15 | 15 | 9/16" | 28.5 | 19 | 7 | 2 | 0520 7000 015 |
| | BSN 520 1 x 18 | 18 | 11/16" | 30 | 21.5 | 7 | 2 | 0520 7000 018 |
| | BSN 520 1 x 19 | 19 | 3/4" | 30.5 | 22 | 7 | 2 | 0520 7000 019 |
| | BSN 520 1 x 20 | 20 | 13/16" | 32 | 22.5 | 7 | 2 | 0520 7000 020 |
| | BSN 520 1 x 22 | 22 | 7/8" | 35 | 23.5 | 7 | 2 | 0520 7000 022 |
| | BSN 520 1 x 23 | 23 | 15/16" | 35.5 | 25.5 | 7 | 2 | 0520 7000 023 |
| BSN 520 1 x 27 | 27 | 1 1/16" | 37.5 | 27.5 | 7 | 2 | 0520 7000 027 | |

BSN type 521 for 1 line

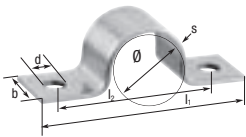

| NORMAFIX® BSN TYPE 521 FOR 1 LINE | | | | | | | | |
|-----------------------------------|----------------|-----------------|-----------|-------------------------|-------------------------|----------------------|---------------------------|-------------------|
| Width b in mm | Designation | Clamping ranges | | l ₁ in mm | l ₂ in mm | Bore hole in mm d | Mat. thickness in mm s | W1 Product No. |
| | | in mm | in inches | | | | | |
| 20 | BSN 521 1 x 7 | 7 | 1/4" | 44 | 28 | 7 | 2 | 0521 7000 007 |
| | BSN 521 1 x 9 | 9 | 3/8" | 48 | 32 | 7 | 2 | 0521 7000 009 |
| | BSN 521 1 x 10 | 10 | 3/8" | 49 | 33 | 7 | 2 | 0521 7000 010 |
| | BSN 521 1 x 11 | 11 | 7/16" | 50 | 34 | 7 | 2 | 0521 7000 011 |
| | BSN 521 1 x 12 | 12 | 1/2" | 51 | 35 | 7 | 2 | 0521 7000 012 |
| | BSN 521 1 x 13 | 13 | 1/2" | 53 | 37 | 7 | 2 | 0521 7000 013 |
| | BSN 521 1 x 15 | 15 | 9/16" | 56 | 40 | 7 | 2 | 0521 7000 015 |
| | BSN 521 1 x 18 | 18 | 11/16" | 59 | 43 | 7 | 2 | 0521 7000 018 |
| | BSN 521 1 x 19 | 19 | 3/4" | 60.5 | 44.5 | 7 | 2 | 0521 7000 019 |
| | BSN 521 1 x 20 | 20 | 13/16" | 65 | 49 | 7 | 2 | 0521 7000 020 |
| | BSN 521 1 x 22 | 22 | 7/8" | 67 | 51 | 7 | 2 | 0521 7000 022 |
| | BSN 521 1 x 23 | 23 | 15/16" | 68 | 52 | 7 | 2 | 0521 7000 023 |
| | BSN 521 1 x 26 | 27 | 1" | 68 | 52 | 7 | 2 | 0521 7000 027 |

BSN type 522 for 2 lines

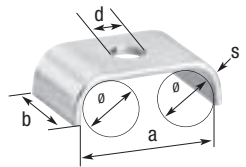

| NORMAFIX® BSN TYPE 522 FOR 2 LINES | | | | | | | |
|------------------------------------|----------------|-----------------|-----------|------------|----------------------|---------------------------|-------------------|
| Width b in mm | Designation | Clamping ranges | | a in mm | Bore hole in mm d | Mat. thickness in mm s | W1 Product No. |
| | | in mm | in inches | | | | |
| 20 | BSN 522 2 x 9 | 9 | 3/8" | 26 | 7 | 2 | 0522 7000 009 |
| | BSN 522 2 x 10 | 10 | 3/8" | 28 | 7 | 2 | 0522 7000 010 |
| | BSN 522 2 x 12 | 12 | 1/2" | 32 | 7 | 2 | 0522 7000 012 |
| | BSN 522 2 x 13 | 13 | 1/2" | 34 | 7 | 2 | 0522 7000 013 |
| | BSN 522 2 x 15 | 15 | 9/16" | 38 | 7 | 2 | 0522 7000 015 |
| | BSN 522 2 x 18 | 18 | 11/16" | 44 | 7 | 2 | 0522 7000 018 |
| | BSN 522 2 x 19 | 19 | 3/4" | 46 | 7 | 2 | 0522 7000 019 |
| | BSN 522 2 x 20 | 20 | 13/16" | 48 | 7 | 2 | 0522 7000 020 |
| | BSN 522 2 x 22 | 22 | 7/8" | 52 | 7 | 2 | 0522 7000 022 |

BSS type 530 for 1 line

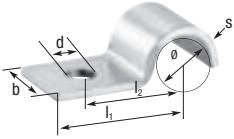

| NORMAFIX® BSS TYPE 530 FOR 1 LINE | | | | | | | | |
|-----------------------------------|------------------|-----------------|-----------|-------------------------|-------------------------|----------------------|---------------------------|-------------------|
| Width b in mm | Designation | Clamping ranges | | l ₁ in mm | l ₂ in mm | Bore hole in mm d | Mat. thickness in mm s | W1 Product No. |
| | | in mm | in inches | | | | | |
| 25 | BSS 530 1 x 10 | 10 | 3/8" | 28 | 18.5 | 9 | 3 | 0530 7000 010 |
| | BSS 530 1 x 12 | 12 | 1/2" | 39 | 24 | 9 | 3 | 0530 7000 012 |
| | BSS 530 1 x 13 | 13 | 1/2" | 39.5 | 24.5 | 9 | 3 | 0530 7000 013 |
| | BSS 530 1 x 15 | 15 | 9/16" | 40.5 | 25.5 | 9 | 3 | 0530 7000 015 |
| | BSS 530 1 x 18 | 18 | 11/16" | 42 | 28 | 9 | 3 | 0530 7000 018 |
| | BSS 530 1 x 19 | 19 | 3/4" | 43.5 | 29 | 9 | 3 | 0530 7000 019 |
| | BSS 530 1 x 20 | 20 | 13/16" | 44 | 29.5 | 9 | 3 | 0530 7000 020 |
| | BSS 530 1 x 22 | 22 | 7/8" | 44 | 29.5 | 9 | 3 | 0530 7000 022 |
| | BSS 530 1 x 23 | 23 | 15/16" | 44.5 | 30 | 9 | 3 | 0530 7000 023 |
| | BSS 530 1 x 26 | 26 | 1" | 52 | 36 | 9 | 3 | 0530 7000 026 |
| | BSS 530 1 x 28.5 | 28.5 | 1 1/8" | 52 | 36 | 9 | 3 | 0530 7000 028 |
| | BSS 530 1 x 31 | 31 | 1 1/4" | 56 | 40 | 9 | 3 | 0530 7000 031 |
| | BSS 530 1 x 36 | 36 | 1 7/16" | 58 | 41.5 | 9 | 3 | 0530 7000 036 |
| | BSS 530 1 x 39 | 39 | 1 9/16" | 58.5 | 42 | 9 | 3 | 0530 7000 039 |
| BSS 530 1 x 43 | 43 | 1 11/16" | 70 | 50 | 9 | 3 | 0530 7000 043 | |

BSS type 531 for 1 line

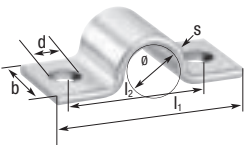

| NORMAFIX® BSS TYPE 531 FOR 1 LINE | | | | | | | | |
|-----------------------------------|------------------|-----------------|-----------|-------------------------|-------------------------|----------------------|---------------------------|-------------------|
| Width b in mm | Designation | Clamping ranges | | l ₁ in mm | l ₂ in mm | Bore hole in mm d | Mat. thickness in mm s | W1 Product No. |
| | | in mm | in inches | | | | | |
| 25 | BSS 531 1 x 10 | 10 | 3/8" | 28 | 18.5 | 9 | 3 | 0531 7000 010 |
| | BSS 531 1 x 12 | 12 | 1/2" | 39 | 24 | 9 | 3 | 0531 7000 012 |
| | BSS 531 1 x 13 | 13 | 1/2" | 39.5 | 24.5 | 9 | 3 | 0531 7000 013 |
| | BSS 531 1 x 15 | 15 | 9/16" | 40.5 | 25.5 | 9 | 3 | 0531 7000 015 |
| | BSS 531 1 x 18 | 18 | 11/16" | 42 | 28 | 9 | 3 | 0531 7000 018 |
| | BSS 531 1 x 19 | 19 | 3/4" | 43.5 | 29 | 9 | 3 | 0531 7000 019 |
| | BSS 531 1 x 20 | 20 | 13/16" | 44 | 29.5 | 9 | 3 | 0531 7000 020 |
| | BSS 531 1 x 22 | 22 | 7/8" | 44 | 29.5 | 9 | 3 | 0531 7000 022 |
| | BSS 531 1 x 23 | 23 | 15/16" | 44.5 | 30 | 9 | 3 | 0531 7000 023 |
| | BSS 531 1 x 26 | 26 | 1" | 52 | 36 | 9 | 3 | 0531 7000 026 |
| | BSS 531 1 x 28.5 | 28.5 | 1 1/8" | 52 | 36 | 9 | 3 | 0531 7000 028 |
| | BSS 531 1 x 31 | 31 | 1 1/4" | 56 | 40 | 9 | 3 | 0531 7000 031 |
| | BSS 531 1 x 36 | 36 | 1 7/16" | 58 | 41.5 | 9 | 3 | 0531 7000 036 |
| | BSS 531 1 x 39 | 39 | 1 9/16" | 58.5 | 42 | 9 | 3 | 0531 7000 039 |
| BSS 531 1 x 43 | 43 | 1 11/16" | 70 | 50 | 9 | 3 | 0531 7000 043 | |

BSS type 532 for 2 lines

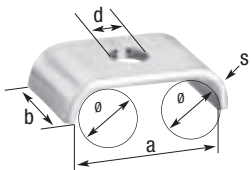

| NORMAFIX® BSS TYPE 532 FOR 2 LINES | | | | | | | |
|------------------------------------|----------------|-----------------|-----------|------------|----------------------|---------------------------|-------------------|
| Width b in mm | Designation | Clamping ranges | | a in mm | Bore hole in mm d | Mat. thickness in mm s | W1 Product No. |
| | | in mm | in inches | | | | |
| 25 | BSS 532 2 x 10 | 10 | 3/8" | 30 | 9 | 3 | 0532 7000 010 |
| | BSS 532 2 x 12 | 12 | 1/2" | 34 | 9 | 3 | 0532 7000 012 |
| | BSS 532 2 x 13 | 13 | 1/2" | 36 | 9 | 3 | 0532 7000 013 |
| | BSS 532 2 x 15 | 15 | 9/16" | 40 | 9 | 3 | 0532 7000 015 |
| | BSS 532 2 x 18 | 18 | 11/16" | 46 | 9 | 3 | 0532 7000 018 |
| | BSS 532 2 x 20 | 20 | 13/16" | 50 | 9 | 3 | 0532 7000 020 |
| | BSS 532 2 x 22 | 22 | 7/8" | 54 | 9 | 3 | 0532 7000 022 |
| | BSS 532 2 x 23 | 23 | 15/16" | 56 | 9 | 3 | 0532 7000 023 |
| | BSS 532 2 x 26 | 26 | 1" | 62 | 9 | 3 | 0532 7000 026 |

BS – VERSIONS

BS type 540 for 1 line

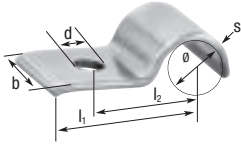

| NORMAFIX® BS TYPE 540 FOR 1 LINE (in accordance with DIN 1596) | | | | | | | | |
|--|-----------------|-----------------|-----------|-------------------------|-------------------------|----------------------|---------------------------|-------------------|
| Width b in mm | Designation | Clamping ranges | | l ₁ in mm | l ₂ in mm | Bore hole in mm d | Mat. thickness in mm s | W1 Product No. |
| | | in mm | in inches | | | | | |
| 16 | BS 540 1 x 7 | 7 | 1/4" | 26 | 14 | 6.6 | 2 | 0540 7000 007 |
| | BS 540 1 x 9 | 9 | 3/8" | 28 | 16 | 6.6 | 2 | 0540 7000 009 |
| 20 | BS 540 1 x 13 | 13 | 1/2" | 30 | 18 | 6.6 | 2 | 0540 7000 013 |
| | BS 540 1 x 15.5 | 15.5 | 5/8" | 32 | 20 | 6.6 | 2 | 0540 7000 015 |
| | BS 540 1 x 19 | 19 | 3/4" | 34 | 22 | 6.6 | 2 | 0540 7000 019 |
| 25 | BS 540 1 x 23 | 23 | 15/16" | 43 | 28 | 9 | 3 | 0540 7000 023 |
| | BS 540 1 x 26 | 26 | 1" | 44 | 29 | 9 | 3 | 0540 7000 026 |
| | BS 540 1 x 28.5 | 28.5 | 1 1/8" | 47 | 32 | 9 | 3 | 0540 7000 028 |
| | BS 540 1 x 31 | 31 | 1 1/4" | 47 | 32 | 9 | 3 | 0540 7000 031 |
| 30 | BS 540 1 x 33 | 33 | 1 5/16" | 56 | 36 | 9 | 3 | 0540 7000 033 |
| | BS 540 1 x 36 | 36 | 1 7/16" | 57 | 40 | 11 | 3 | 0540 7000 036 |
| | BS 540 1 x 39 | 39 | 1 9/16" | 59 | 42 | 11 | 3 | 0540 7000 039 |
| | BS 540 1 x 43 | 43 | 1 11/16" | 61 | 44 | 11 | 3 | 0540 7000 043 |
| 40 | BS 540 1 x 46 | 46 | 1 13/16" | 62 | 45 | 11 | 3 | 0540 7000 046 |
| | BS 540 1 x 49 | 49 | 1 15/16" | 67 | 48 | 14 | 4 | 0540 7000 049 |
| | BS 540 1 x 52 | 52 | 2 1/16" | 72 | 53 | 14 | 4 | 0540 7000 052 |
| | BS 540 1 x 58 | 58 | 2 1/4" | 74 | 55 | 14 | 4 | 0540 7000 058 |
| | BS 540 1 x 61 | 61 | 2 3/8" | 77 | 58 | 14 | 4 | 0540 7000 061 |

BS type 541 for 1 line

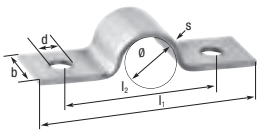

| NORMAFIX® BS TYPE 541 FOR 1 LINE (in accordance with DIN 1597) | | | | | | | | |
|--|-----------------|-----------------|-----------|-------------------------|-------------------------|----------------------|---------------------------|-------------------|
| Width b in mm | Designation | Clamping ranges | | l ₁ in mm | l ₂ in mm | Bore hole in mm d | Mat. thickness in mm s | W1 Product No. |
| | | in mm | in inches | | | | | |
| 16 | BS 541 1 x 7 | 7 | 1/4" | 44 | 28 | 5.5 | 1.5 | 0541 7000 007 |
| | BS 541 1 x 9 | 9 | 3/8" | 48 | 32 | 5.5 | 1.5 | 0541 7000 009 |
| 20 | BS 541 1 x 13 | 13 | 1/2" | 52 | 36 | 5.5 | 1.5 | 0541 7000 013 |
| | BS 541 1 x 15.5 | 15.5 | 5/8" | 56 | 40 | 5.5 | 1.5 | 0541 7000 015 |
| | BS 541 1 x 19 | 19 | 3/4" | 60 | 44 | 5.5 | 1.5 | 0541 7000 019 |
| 25 | BS 541 1 x 23 | 23 | 15/16" | 76 | 56 | 6.6 | 2 | 0541 7000 023 |
| | BS 541 1 x 26 | 26 | 1" | 78 | 58 | 6.6 | 2 | 0541 7000 026 |
| | BS 541 1 x 28.5 | 28.5 | 1 1/8" | 84 | 64 | 6.6 | 2 | 0541 7000 028 |
| | BS 541 1 x 31 | 31 | 1 1/4" | 84 | 64 | 6.6 | 2 | 0541 7000 031 |
| 30 | BS 541 1 x 33 | 33 | 1 5/16" | 92 | 72 | 6.6 | 2 | 0541 7000 033 |
| | BS 541 1 x 36 | 36 | 1 7/16" | 104 | 80 | 9 | 3 | 0541 7000 036 |
| | BS 541 1 x 39 | 39 | 1 9/16" | 108 | 84 | 9 | 3 | 0541 7000 039 |
| | BS 541 1 x 43 | 43 | 1 11/16" | 112 | 88 | 9 | 3 | 0541 7000 043 |
| 40 | BS 541 1 x 46 | 46 | 1 13/16" | 114 | 90 | 9 | 3 | 0541 7000 046 |
| | BS 541 1 x 49 | 49 | 1 15/16" | 118 | 90 | 11 | 3 | 0541 7000 049 |
| | BS 541 1 x 52 | 52 | 2 1/16" | 134 | 106 | 11 | 3 | 0541 7000 052 |
| | BS 541 1 x 58 | 58 | 2 1/4" | 138 | 110 | 11 | 3 | 0541 7000 058 |
| | BS 541 1 x 61 | 61 | 2 3/8" | 138 | 110 | 11 | 3 | 0541 7000 061 |

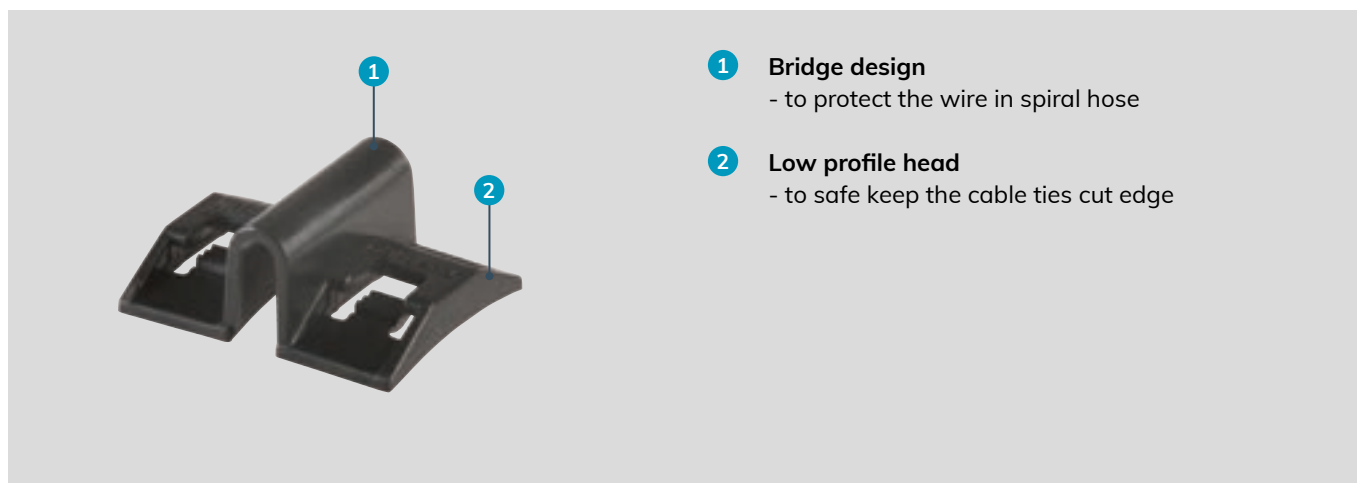

- 1 Bridge design**
- to protect the wire in spiral hose
- 2 Low profile head**
- to safe keep the cable ties cut edge

NORMAFIX® HVAC Clip – a flexible solution for fixing spiral hoses

In combination with our cable tie, the NORMAFIX® HVAC Clip makes it very easy to attach externally corrugated spiral hoses in HVAC (heating, ventilation, air conditioning) installations. It is a lightweight, flexible and economical alternative to metal spiral hose clamps. The patented shape and functionality of the NORMAFIX® HVAC Clip makes it possible to span the crossing of the hose spiral. Thanks to this special geometry, the cable tie can grip the hose around its whole perimeter so that it is fixed safely. Suitable for cable ties with bandwidth 9 mm. The shape of our HVAC Clip and our cable ties match perfectly, forming a reliable system. This system works independently of the direction of the spiral on the hose. The HVAC Clip can be used for both clockwise and counter clockwise spiral hoses. One clip fits all.

Advantages at a glance

- ✓ Economical, lightweight and flexible alternative to spiral hose clamps
- ✓ Applicable for both clockwise and counter clockwise spiral hoses
- ✓ Simple installation by hand, no special tools required

Did you know?

We have the right cable ties for you:
simply check pages 122 to 125.

Applications

- For any HVAC applications with spiral hoses
- Heating, ventilation, air conditioning
- Ventilation of greenhouses
- Clean room ventilation
- Welding fume exhaust

Technical data & Ordering information

| NORMAFIX® HVAC CLIP | |
|---------------------|---------------|
| Description | Product No. |
| HVAC CLIP | 0859 2066 001 |

Material

Polyamide 6.6



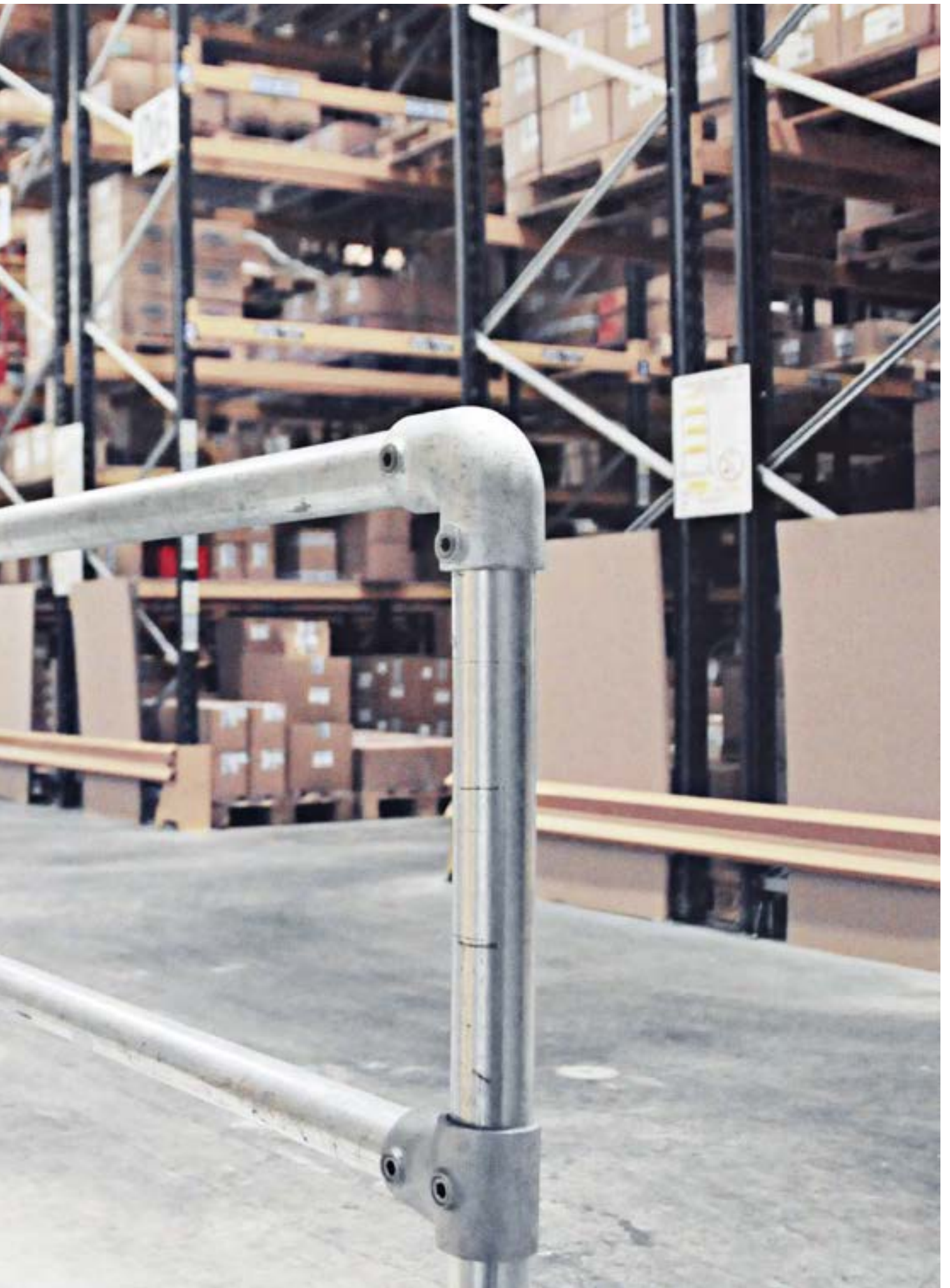

TUBE CLAMP FITTINGS

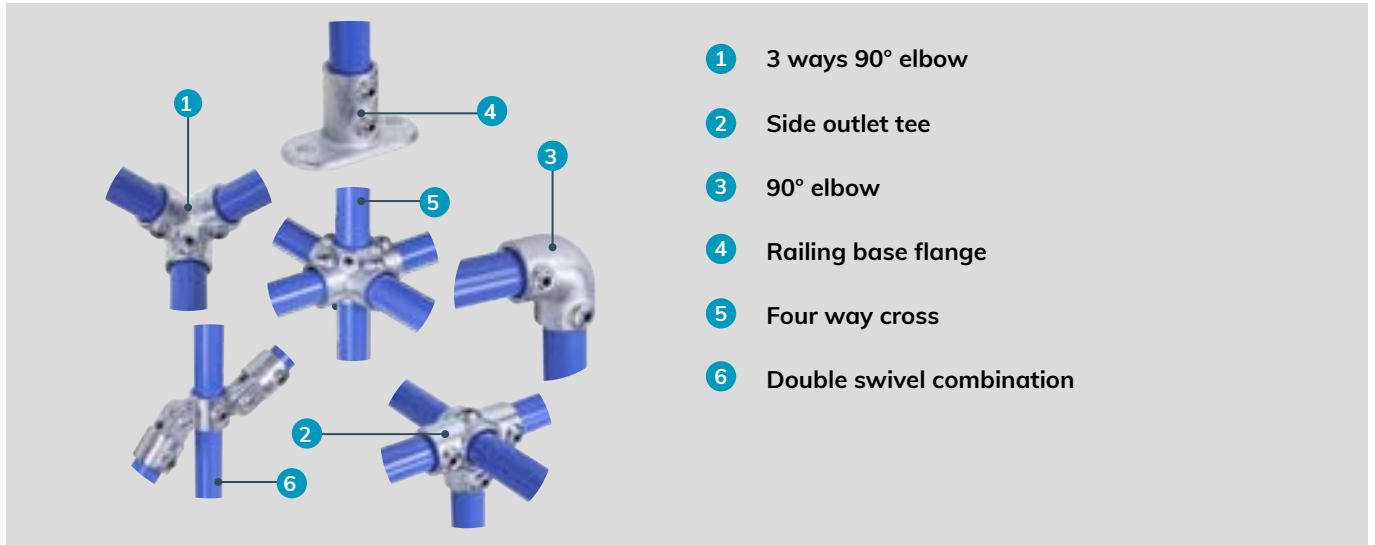

Tube clamp fittings for safety systems

Made of malleable galvanized iron to ensure strength, quality and conformity of production. NORMAFIX® Tube Clamp Fittings can be easily assembled on pipes in order to create safety systems.

Advantages at a glance

- ✓ Stainless steel screw
- ✓ Warranty up to 1500 N/m load
- ✓ No welding, so no fire permits required
- ✓ No threading, no bolting
- ✓ Can be assembled with a simple hexagonal key
- ✓ A versatile system that allows changes on site
- ✓ Can be painted

Applications

- Handrails
- Safety rails/Protective barriers
- Fall protections
- Other applications for safety work
- Fix railings
- Machinery guard
- Playgrounds

Material

Malleable galvanized iron

Sleeve joint



| NORMAFIX® SLEEVE JOINT | | | |
|------------------------|----------------|------|---------------------------------------|
| Designation | Diameter in mm | a mm | Malleable galvanized iron Product No. |
| SLEEVE JOINT 26.9 | 26.9 | 76 | 0819 6301 027 |
| SLEEVE JOINT 33.7 | 33.7 | 90 | 0819 6301 034 |
| SLEEVE JOINT 42.4 | 42.4 | 100 | 0819 6301 042 |
| SLEEVE JOINT 48.3 | 48.3 | 100 | 0819 6301 048 |
| SLEEVE JOINT 60.3 | 60.3 | 120 | 0819 6301 060 |

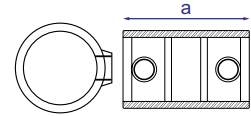

Refer to page 195 and 196

Expanding connector



| NORMAFIX® EXPANDING CONNECTOR | | | | |
|-------------------------------|----------------|------|------|---------------------------------------|
| Designation | Diameter in mm | a mm | b mm | Malleable galvanized iron Product No. |
| EXPANDING CONNECTOR 33.7 | 33.7 | 78 | 20 | 0819 6302 034 |
| EXPANDING CONNECTOR 42.4 | 42.4 | 78 | 20 | 0819 6302 042 |
| EXPANDING CONNECTOR 48.3 | 48.3 | 78 | 20 | 0819 6302 048 |

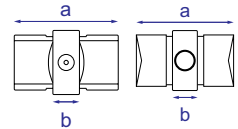

Refer to page 195 and 196

90° elbow



| NORMAFIX® 90° ELBOW | | | |
|---------------------|----------------|------|---------------------------------------|
| Designation | Diameter in mm | a mm | Malleable galvanized iron Product No. |
| 90° ELBOW 26.9 | 26.9 | 41 | 0819 6303 027 |
| 90° ELBOW 33.7 | 33.7 | 46 | 0819 6303 034 |
| 90° ELBOW 42.4 | 42.4 | 60 | 0819 6303 042 |
| 90° ELBOW 48.3 | 48.3 | 68 | 0819 6303 048 |
| 90° ELBOW 60.3 | 60.3 | 84 | 0819 6303 060 |

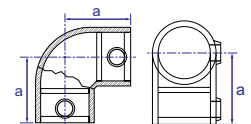

Refer to page 195 and 196

NORMAFIX®

TUBE CLAMP FITTINGS

Short T



| NORMAFIX® SHORT T | | | |
|-------------------|----------------|------|---------------------------------------|
| Designation | Diameter in mm | a mm | Malleable galvanized iron Product No. |
| SHORT T 26.9 | 26.9 | 41 | 0819 6304 027 |
| SHORT T 33.7 | 33.7 | 46 | 0819 6304 034 |
| SHORT T 42.4 | 42.4 | 60 | 0819 6304 042 |
| SHORT T 48.3 | 48.3 | 68 | 0819 6304 048 |
| SHORT T 60.3 | 60.3 | 84 | 0819 6304 060 |

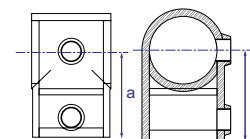

Refer to page 195 and 196

Long T



NORMAFIX®

| NORMAFIX® LONG T | | | | |
|------------------|----------------|------|------|---------------------------------------|
| Designation | Diameter in mm | a mm | b mm | Malleable galvanized iron Product No. |
| LONG T 26.9 | 26.9 | 41 | 82 | 0819 6305 027 |
| LONG T 33.7 | 33.7 | 46 | 92 | 0819 6305 034 |
| LONG T 42.4 | 42.4 | 60 | 120 | 0819 6305 042 |
| LONG T 48.3 | 48.3 | 68 | 135 | 0819 6305 048 |
| LONG T 60.3 | 60.3 | 84 | 168 | 0819 6305 060 |

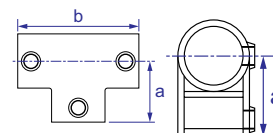

Refer to page 195 and 196

Wall flange



| NORMAFIX® WALL FLANGE | | | | | |
|-----------------------|----------------|------|------|------|---------------------------------------|
| Designation | Diameter in mm | b mm | c mm | d mm | Malleable galvanized iron Product No. |
| WALL FLANGE 26.9 | 26.9 | 42 | 83 | 59 | 0819 6306 027 |
| WALL FLANGE 33.7 | 33.7 | 48 | 89 | 65 | 0819 6306 034 |
| WALL FLANGE 42.4 | 42.4 | 51 | 102 | 76 | 0819 6306 042 |
| WALL FLANGE 48.3 | 48.3 | 59 | 114 | 88.5 | 0819 6306 048 |
| WALL FLANGE 60.3 | 60.3 | 64 | 128 | 97 | 0819 6306 060 |

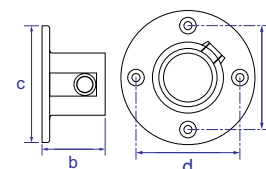

Refer to page 195 and 196

Railing base flange



| NORMAFIX® RAILING BASE FLANGE | | | | | | |
|-------------------------------|----------------|------|------|------|------|---------------------------------------|
| Designation | Diameter in mm | a mm | c mm | d mm | e mm | Malleable galvanized iron Product No. |
| RAILING BASE FLANGE 26.9 | 26.9 | 60 | 105 | 76 | 52 | 0819 6307 027 |
| RAILING BASE FLANGE 33.7 | 33.7 | 71 | 127 | 89 | 62 | 0819 6307 034 |
| RAILING BASE FLANGE 42.4 | 42.4 | 84 | 139 | 101 | 72 | 0819 6307 042 |
| RAILING BASE FLANGE 48.3 | 48.3 | 89 | 152 | 114 | 86 | 0819 6307 048 |
| RAILING BASE FLANGE 60.3 | 60.3 | 104 | 165 | 127 | 96 | 0819 6307 060 |

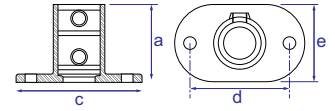

Refer to page 195 and 196

Handrail bracket



| NORMAFIX® HANDRAIL BRACKET | | | | | | | |
|----------------------------|----------------|------|------|------|------|------|---------------------------------------|
| Designation | Diameter in mm | a mm | b mm | c mm | d mm | e mm | Malleable galvanized iron Product No. |
| HANDRAIL BRACKET 26.9 | 26.9 | 54 | 77 | 57 | 44 | 7 | 0819 6308 027 |
| HANDRAIL BRACKET 33.7 | 33.7 | 57 | 80 | 62 | 44 | 7 | 0819 6308 034 |
| HANDRAIL BRACKET 42.4 | 42.4 | 62 | 102 | 82.5 | 45 | 7 | 0819 6308 042 |
| HANDRAIL BRACKET 48.3 | 48.3 | 70 | 107 | 82.5 | 50 | 7 | 0819 6308 048 |

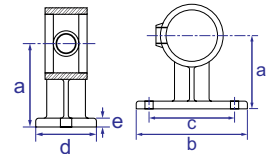

Refer to page 195 and 196

3 ways 90° elbow



| NORMAFIX® 3 WAYS 90° ELBOW | | | |
|----------------------------|----------------|------|---------------------------------------|
| Designation | Diameter in mm | a mm | Malleable galvanized iron Product No. |
| 3 WAYS 90° ELBOW 26.9 | 26.9 | 41 | 0819 6309 027 |
| 3 WAYS 90° ELBOW 33.7 | 33.7 | 48 | 0819 6309 034 |
| 3 WAYS 90° ELBOW 42.4 | 42.4 | 60 | 0819 6309 042 |
| 3 WAYS 90° ELBOW 48.3 | 48.3 | 68 | 0819 6309 048 |
| 3 WAYS 90° ELBOW 60.3 | 60.3 | 84 | 0819 6309 060 |

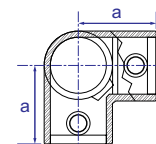

Refer to page 195 and 196



TUBE CLAMP FITTINGS

Corner C/W through tube



| NORMAFIX® CORNER C/W THROUGH TUBE | | | |
|-----------------------------------|----------------|------|---------------------------------------|
| Designation | Diameter in mm | a mm | Malleable galvanized iron Product No. |
| CORNER C/W THRO TUBE 26.9 | 26.9 | 41 | 0819 6310 027 |
| CORNER C/W THRO TUBE 33.7 | 33.7 | 46 | 0819 6310 034 |
| CORNER C/W THRO TUBE 42.4 | 42.4 | 60 | 0819 6310 042 |
| CORNER C/W THRO TUBE 48.3 | 48.3 | 68 | 0819 6310 048 |
| CORNER C/W THRO TUBE 60.3 | 60.3 | 84 | 0819 6310 060 |

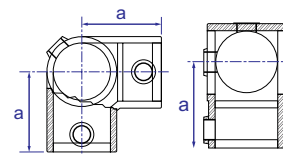

Refer to page 195 and 196

Two socket cross



| NORMAFIX® TWO SOCKET CROSS | | | |
|----------------------------|----------------|------|---------------------------------------|
| Designation | Diameter in mm | a mm | Malleable galvanized iron Product No. |
| TWO SOCKET CROSS 26.9 | 26.9 | 82 | 0819 6311 027 |
| TWO SOCKET CROSS 33.7 | 33.7 | 92 | 0819 6311 034 |
| TWO SOCKET CROSS 42.4 | 42.4 | 120 | 0819 6311 042 |
| TWO SOCKET CROSS 48.3 | 48.3 | 135 | 0819 6311 048 |
| TWO SOCKET CROSS 60.3 | 60.3 | 168 | 0819 6311 060 |

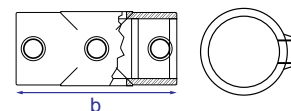

Refer to page 195 and 196

Side outlet tee



| NORMAFIX® SIDE OUTLET TEE | | | | |
|---------------------------|----------------|------|------|---------------------------------------|
| Designation | Diameter in mm | a mm | b mm | Malleable galvanized iron Product No. |
| SIDE OUTLET TEE 26.9 | 26.9 | 41 | 82 | 0819 6312 027 |
| SIDE OUTLET TEE 33.7 | 33.7 | 46 | 92 | 0819 6312 034 |
| SIDE OUTLET TEE 42.4 | 42.4 | 60 | 120 | 0819 6312 042 |
| SIDE OUTLET TEE 48.3 | 48.3 | 68 | 136 | 0819 6312 048 |
| SIDE OUTLET TEE 60.3 | 60.3 | 84.5 | 169 | 0819 6312 060 |

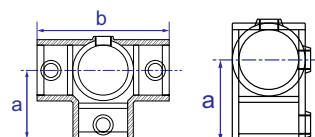

Refer to page 195 and 196

Four way cross and center



| NORMAFIX® FOUR WAY CROSS AND CENTER | | | |
|-------------------------------------|----------------|------|---------------------------------------|
| Designation | Diameter in mm | a mm | Malleable galvanized iron Product No. |
| FOUR WAY CROSS AND CENTER 26.9 | 26.9 | 41 | 0819 6313 027 |
| FOUR WAY CROSS AND CENTER 33.7 | 33.7 | 46 | 0819 6313 034 |
| FOUR WAY CROSS AND CENTER 42.4 | 42.4 | 60 | 0819 6313 044 |
| FOUR WAY CROSS AND CENTER 48.3 | 48.3 | 68 | 0819 6313 048 |

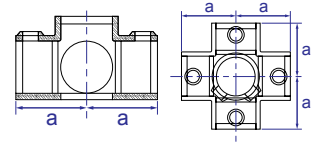

Refer to page 195 and 196

Fixing pad



| NORMAFIX® FIXING PAD | | | | |
|----------------------|----------------|------|------|---------------------------------------|
| Designation | Diameter in mm | a mm | b mm | Malleable galvanized iron Product No. |
| FIXING PAD 33.7 | 33.7 | 60 | 43 | 0819 6314 034 |
| FIXING PAD 42.4 | 42.4 | 66 | 48 | 0819 6314 042 |
| FIXING PAD 48.3 | 48.3 | 70 | 52 | 0819 6314 048 |

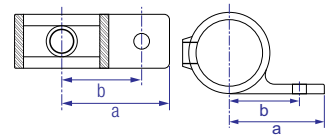

Refer to page 195 and 196

Double wall coupler



| NORMAFIX® DOUBLE WALL COUPLER | | | | |
|-------------------------------|----------------|------|------|---------------------------------------|
| Designation | Diameter in mm | a mm | b mm | Malleable galvanized iron Product No. |
| DOUBLE WALL COUPLER 33.7 | 33.7 | 86 | 120 | 0819 6315 034 |
| DOUBLE WALL COUPLER 42.4 | 42.4 | 95 | 130 | 0819 6315 042 |
| DOUBLE WALL COUPLER 48.3 | 48.3 | 104 | 140 | 0819 6315 048 |

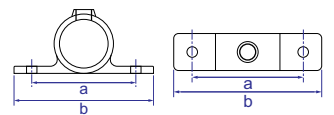

Refer to page 195 and 196

NORMAFIX®

TUBE CLAMP FITTINGS

Male swivel



| NORMAFIX® MALE SWIVEL | | | |
|-----------------------|----------------|------|---------------------------------------|
| Designation | Diameter in mm | b mm | Malleable galvanized iron Product No. |
| MALE SWIVEL 33.7 | 33.7 | 43.5 | 0819 6316 034 |
| MALE SWIVEL 42.4 | 42.4 | 48 | 0819 6316 042 |
| MALE SWIVEL 48.3 | 48.3 | 53 | 0819 6316 048 |
| MALE SWIVEL 60.3 | 60.3 | 60 | 0819 6316 060 |

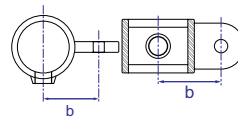

Refer to page 195 and 196

Female swivel



| NORMAFIX® FEMALE SWIVEL | | | | |
|-------------------------|----------------|------|------|---------------------------------------|
| Designation | Diameter in mm | a mm | b mm | Malleable galvanized iron Product No. |
| FEMALE SWIVEL 33.7 | 33.7 | 61 | 38 | 0819 6317 034 |
| FEMALE SWIVEL 42.4 | 42.4 | 69 | 46 | 0819 6317 042 |
| FEMALE SWIVEL 48.3 | 48.3 | 77 | 55 | 0819 6317 048 |
| FEMALE SWIVEL 60.3 | 60.3 | 89 | 65 | 0819 6317 060 |

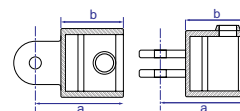

Refer to page 195 and 196

Gate eye



| NORMAFIX® GATE EYE | | | | |
|--------------------|----------------|------|------|---------------------------------------|
| Designation | Diameter in mm | a mm | b mm | Malleable galvanized iron Product No. |
| GATE EYE 33.7 | 33.7 | 33 | 25.5 | 0819 6318 034 |
| GATE EYE 42.4 | 42.4 | 38 | 25 | 0819 6318 042 |
| GATE EYE 48.3 | 48.3 | 41 | 25 | 0819 6318 048 |

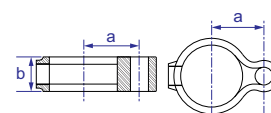

Refer to page 195 and 196

Gate hinge



| NORMAFIX® GATE HINGE | | | | | | |
|----------------------|----------------|------|------|------|------|---------------------------------------|
| Designation | Diameter in mm | a mm | b mm | c mm | d mm | Malleable galvanized iron Product No. |
| GATE HINGE 33.7 | 33.7 | 33 | 25.5 | 38 | 12 | 0819 6319 034 |
| GATE HINGE 42.4 | 42.4 | 38 | 25 | 38 | 12 | 0819 6319 042 |
| GATE HINGE 48.3 | 48.3 | 25 | 25 | 38 | 12 | 0819 6319 048 |

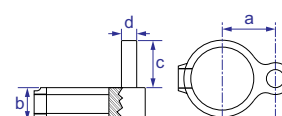

Refer to page 195 and 196

Double male swivel



| NORMAFIX® DOUBLE MALE SWIVEL | | | |
|------------------------------|----------------|------|---------------------------------------|
| Designation | Diameter in mm | b mm | Malleable galvanized iron Product No. |
| DOUBLE MALE SWIVEL 33.7 | 33.7 | 84 | 0819 6320 034 |
| DOUBLE MALE SWIVEL 42.4 | 42.4 | 95 | 0819 6320 042 |
| DOUBLE MALE SWIVEL 48.3 | 48.3 | 105 | 0819 6320 048 |
| DOUBLE MALE SWIVEL 60.3 | 60.3 | 124 | 0819 6320 060 |

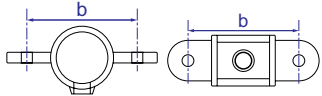

Refer to page 195 and 196

90° corner male swivel



| NORMAFIX® 90° CORNER MALE SWIVEL | | | |
|----------------------------------|----------------|------|---------------------------------------|
| Designation | Diameter in mm | a mm | Malleable galvanized iron Product No. |
| 90° CORNER MALE SWIVEL 33.7 | 33.7 | 43.5 | 0819 6321 034 |
| 90° CORNER MALE SWIVEL 42.4 | 42.4 | 48 | 0819 6321 042 |
| 90° CORNER MALE SWIVEL 48.3 | 48.3 | 53 | 0819 6321 048 |
| 90° CORNER MALE SWIVEL 60.3 | 60.3 | 62 | 0819 6321 060 |

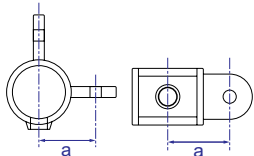

Refer to page 195 and 196

90° crossover



| NORMAFIX® 90° CROSSOVER | | | | |
|-------------------------|----------------|------|------|---------------------------------------|
| Designation | Diameter in mm | a mm | b mm | Malleable galvanized iron Product No. |
| 90° CROSSOVER 26.9 | 26.9 | 31.5 | 38 | 0819 6322 027 |
| 90° CROSSOVER 33.7 | 33.7 | 38.5 | 41 | 0819 6322 034 |
| 90° CROSSOVER 42.4 | 42.4 | 46 | 49.5 | 0819 6322 042 |
| 90° CROSSOVER 48.3 | 48.3 | 51 | 55 | 0819 6322 048 |
| 90° CROSSOVER 60.3 | 60.3 | 61 | 67 | 0819 6322 060 |

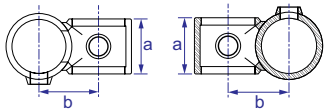

Refer to page 195 and 196

NORMAFIX®

TUBE CLAMP FITTINGS

Single swivel combination



| NORMAFIX® SINGLE SWIVEL COMBINATION | | | | |
|-------------------------------------|----------------|------|-------|---------------------------------------|
| Designation | Diameter in mm | a mm | b mm | Malleable galvanized iron Product No. |
| SINGLE SWIVEL COMBINATION 26.9 | 26.9 | 61 | 106 | 0819 6323 027 |
| SINGLE SWIVEL COMBINATION 33.7 | 33.7 | 61 | 104.5 | 0819 6323 034 |
| SINGLE SWIVEL COMBINATION 42.4 | 42.4 | 69 | 117 | 0819 6323 042 |
| SINGLE SWIVEL COMBINATION 48.3 | 48.3 | 77 | 130 | 0819 6323 048 |
| SINGLE SWIVEL COMBINATION 60.3 | 60.3 | 89 | 152 | 0819 6323 060 |

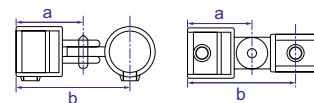

Refer to page 195 and 196

Base swivel combination



| NORMAFIX® BASE SWIVEL COMBINATION | | | | | | | |
|-----------------------------------|----------------|------|------|------|------|------|---------------------------------------|
| Designation | Diameter in mm | a mm | b mm | c mm | d mm | e mm | Malleable galvanized iron Product No. |
| BASE SWIVEL COMBINATION 33.7 | 33.7 | 61 | 112 | 85 | 93 | 52 | 0819 6324 034 |
| BASE SWIVEL COMBINATION 42.4 | 42.4 | 69 | 112 | 85 | 98 | 52 | 0819 6324 042 |
| BASE SWIVEL COMBINATION 48.3 | 48.3 | 77 | 112 | 85 | 109 | 52 | 0819 6324 048 |
| BASE SWIVEL COMBINATION 60.3 | 60.3 | 89 | 112 | 85 | 121 | 152 | 0819 6324 060 |

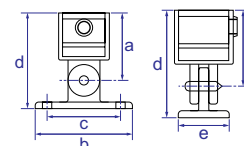

Refer to page 195 and 196

Double swivel combination



| NORMAFIX® DOUBLE SWIVEL COMBINATION | | | |
|-------------------------------------|----------------|------|---------------------------------------|
| Designation | Diameter in mm | b mm | Malleable galvanized iron Product No. |
| DOUBLE SWIVEL COMBINATION 33.7 | 33.7 | 208 | 0819 6325 034 |
| DOUBLE SWIVEL COMBINATION 42.4 | 42.4 | 228 | 0819 6325 042 |
| DOUBLE SWIVEL COMBINATION 48.3 | 48.3 | 259 | 0819 6325 048 |

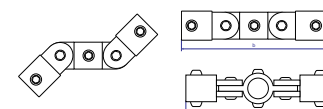

Refer to page 195 and 196

90° corner swivel combination



| NORMAFIX® 90° CORNER SWIVEL COMBINATION | | | |
|---|----------------|-------|---------------------------------------|
| Designation | Diameter in mm | a mm | Malleable galvanized iron Product No. |
| 90° CORNER SWIVEL COMBINATION 33.7 | 33.7 | 104.5 | 0819 6326 034 |
| 90° CORNER SWIVEL COMBINATION 42.4 | 42.4 | 117 | 0819 6326 042 |
| 90° CORNER SWIVEL COMBINATION 48.3 | 48.3 | 130 | 0819 6326 048 |

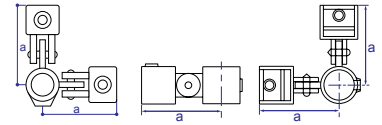

Refer to page 195 and 196

Short tee swivel



| NORMAFIX® SHORT TEE SWIVEL | | | |
|----------------------------|----------------|------|---------------------------------------|
| Designation | Diameter in mm | a mm | Malleable galvanized iron Product No. |
| SHORT TEE SWIVEL 26.9 | 26.9 | 53 | 0819 6327 027 |
| SHORT TEE SWIVEL 33.7 | 33.7 | 59 | 0819 6327 034 |
| SHORT TEE SWIVEL 42.4 | 42.4 | 73 | 0819 6327 042 |
| SHORT TEE SWIVEL 48.3 | 48.3 | 93 | 0819 6327 048 |

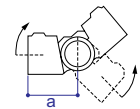

Refer to page 195 and 196

Clamp on tee



| NORMAFIX® CLAMP ON TEE | | | |
|------------------------|----------------|------|---------------------------------------|
| Designation | Diameter in mm | a mm | Malleable galvanized iron Product No. |
| CLAMP ON TEE 33.7 | 33.7 | 52.5 | 0819 6328 034 |
| CLAMP ON TEE 42.4 | 42.4 | 67 | 0819 6328 042 |
| CLAMP ON TEE 48.3 | 48.3 | 76.5 | 0819 6327 048 |

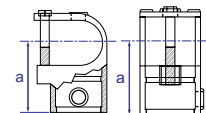

Refer to page 195 and 196

Fence building clamp



| NORMAFIX® FENCE BUILDING CLAMP | | |
|--------------------------------|----------------|--|
| Designation | Diameter in mm | Electrolytic yellow passivated Product No. |
| FENCE BUILDING CLAMP | 48 | 0819 6333 048 |

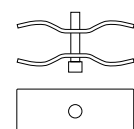

Refer to page 195 and 196

ALU BAND CLAMP

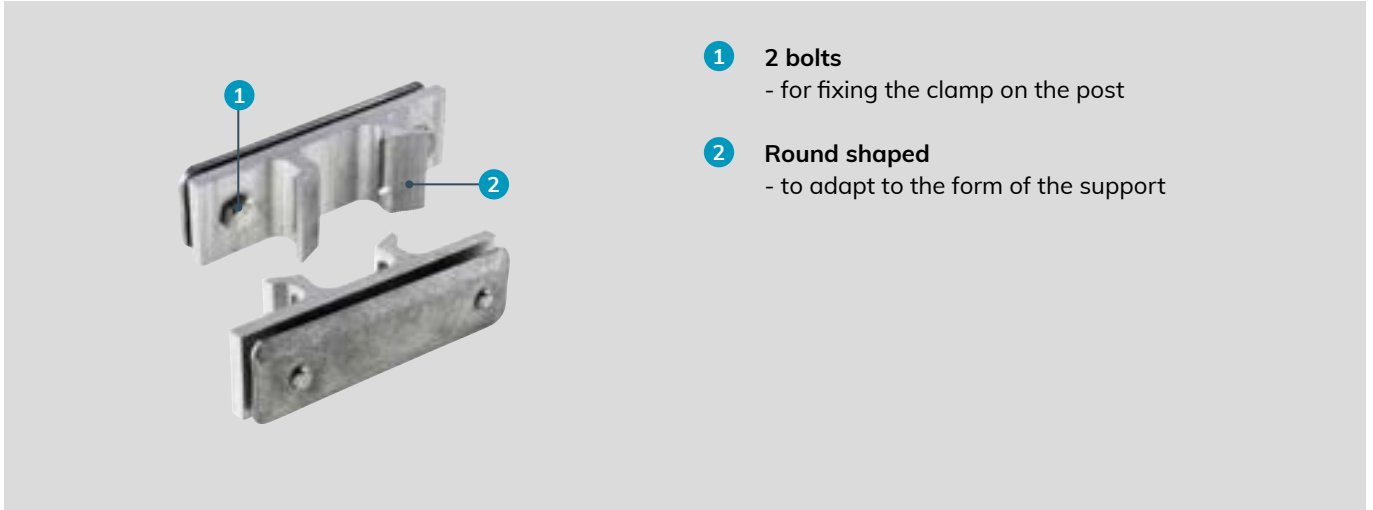

- 1 2 bolts**
- for fixing the clamp on the post
- 2 Round shaped**
- to adapt to the form of the support

Universal traffic sign fixation

Mainly used to hold road signs on a diversity of metal posts or lamppost diameters.



NORMAFIX®

Information

- Includes 2 bolts
- To be used with a worm drive hose clamp

Material

Aluminum

Applications

Traffic signs industry

Technical data & Ordering information

| NORMAFIX® ALU BAND CLAMP | | | |
|--------------------------|--------------|-----------------|----------------------|
| Designation | Length in mm | Number of bolts | Aluminum Product No. |
| ALU BAND CLAMP | 82 | 2 | 0560 7563 082 |
| ALU BAND CLAMP | 120 | 2 | 0560 7563 120 |

Did you know?

We have the right hose clamp for you: Hi-Torque Clamp, simply check page 26.

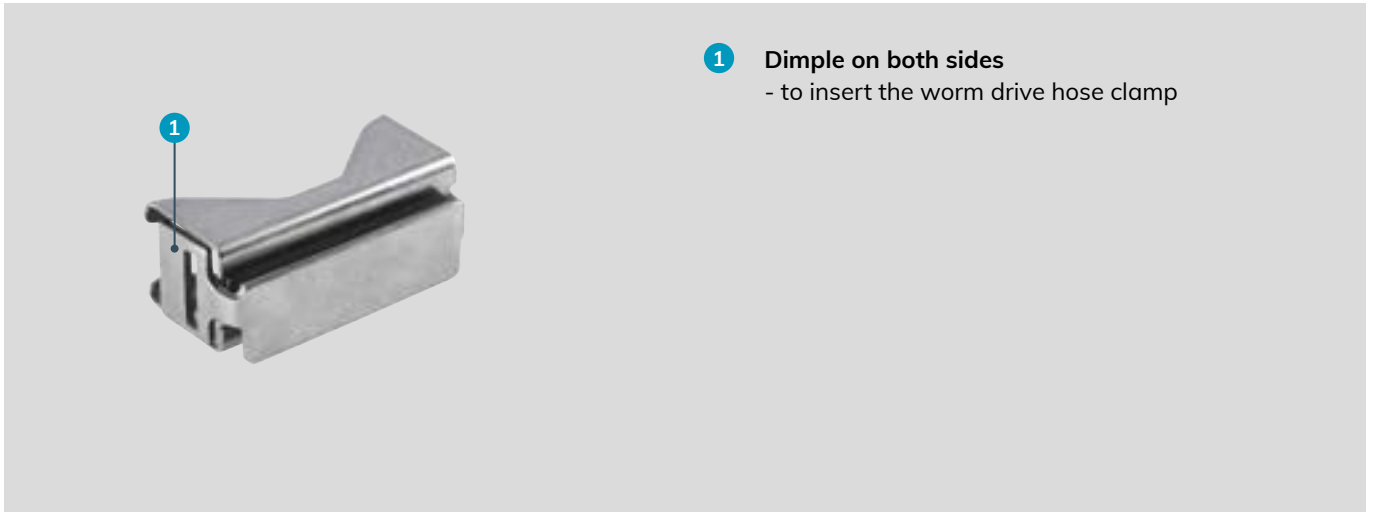

- 1 **Dimple on both sides**
- to insert the worm drive hose clamp

Universal traffic sign fixation

Mainly used to hold road signs on a diversity of metal posts or lamppost diameters.



Information

- To be used with a worm drive hose clamp

Applications

Traffic signs industry

Materials

Stainless steel

Technical data & Ordering information

| NORMAFIX® UNIVERSAL UCC CLAMP | |
|-------------------------------|--------------------------------|
| Designation | Stainless steel Product No. |
| UNIVERSAL UCC CLAMP | 0560 7620 000 |

Did you know?
We have the right hose clamp for you: Hi-Torque product, simply check page 26.

NORMAPLAST® – Hose Connectors

For a helping hand in industrial, commercial and private applications

NORMAPLAST® plastic hose connectors – the NORMA® range of products for rapidly connecting hoses and pipes – are the helping hands that no one working in industrial, commercial or private applications should be without.



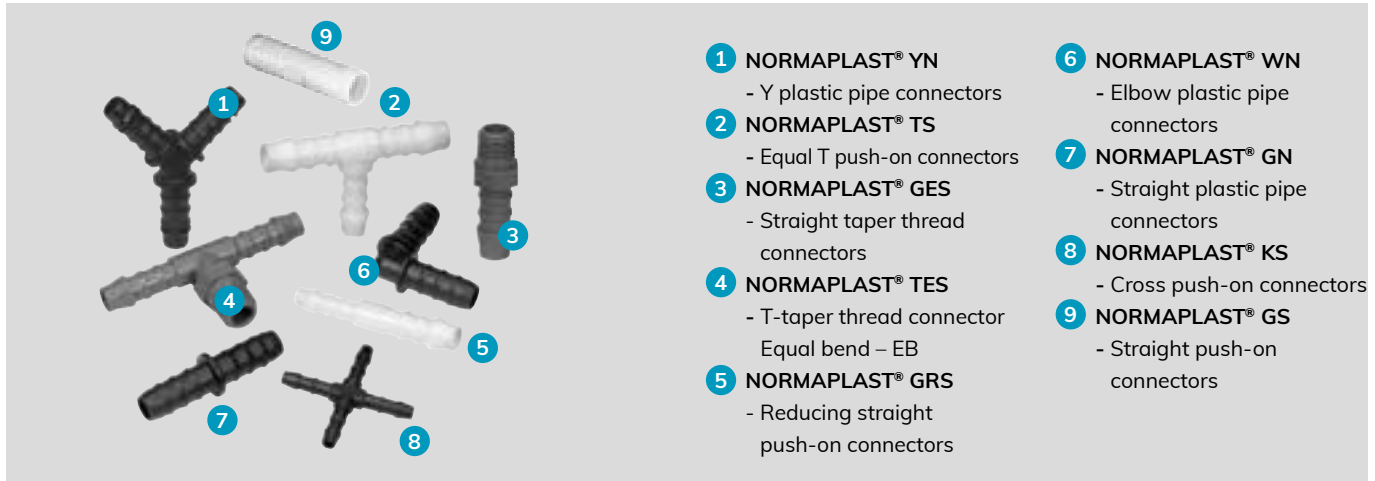

- 1 NORMAPLAST® YN**
- Y plastic pipe connectors
- 2 NORMAPLAST® TS**
- Equal T push-on connectors
- 3 NORMAPLAST® GES**
- Straight taper thread connectors
- 4 NORMAPLAST® TES**
- T-taper thread connector
Equal bend – EB
- 5 NORMAPLAST® GRS**
- Reducing straight push-on connectors
- 6 NORMAPLAST® WN**
- Elbow plastic pipe connectors
- 7 NORMAPLAST® GN**
- Straight plastic pipe connectors
- 8 NORMAPLAST® KS**
- Cross push-on connectors
- 9 NORMAPLAST® GS**
- Straight push-on connectors

Hose connectors

NORMAPLAST® SV products are proven plastic hose and pipe connection components that create secure, reliable and affordable connections in lines used for transporting media. NORMAPLAST® SV hose and pipe connectors are used in the automotive construction industry as well as practically every other industrial sector. They are manufactured according to automotive standards and are NOT suitable for medical applications.

Advantages at a glance

- ✓ Extremely strong
- ✓ Durable
- ✓ Low weight
- ✓ Can be used for damping/absorption
- ✓ Resistant to abrasion
- ✓ Highly resistant to impact

Applications

- Machine building
- White goods
- Chemical industry
- Irrigation systems
- Food and beverage industry
- Railway industry
- Agricultural machines
- Building machines
- Engine manufacturing
- Pump and filter

Did you know?

We also offer products for medical applications with our brand CONNECTORS. You can find more information on the following website:

www.normagroup.com/connectors

Materials

| Materials | | | | |
|--------------------------|--|---|---|---|
| Mechanical Properties | PP Moplen HP501H | POM Polyacetal copolymer standard material hose connectors | PA6 Polyamide unreinforced standard material threaded connectors | PA with glass fiber Polyamide reinforced standard material pipe connectors |
| Operation temperature | 0°C to +80°C short term (up to 1h) max. +100°C | -40°C to 80°C, short-term (up to 1h) 110°C | -40°C to 90°C, short-term (up to 1h) 120°C | -40°C to 120°C, short-term (up to 1h) 150°C |
| Max. admissible pressure | 10bar | 10bar | 10bar | 10bar |

| Applications | Recommended material range |
|--|----------------------------|
| Food area / drinking water area / chemical area | >POM< |
| Chemical area | >PP< |
| Chemical area (with aggressive media) | >PVDF< |
| Fuel / UREA (AdBlue) crank case ventilation | >PA12-GF30< |
| Cooling water / Windshield washer fluid | >PA6.6-GF30< |
| Air (Vaccum brake, Secondary air) TOC (Oil cooler, transmission oil) | >PA6-GF30< |

Thermal properties

In the case of threaded spigots, the expansion coefficient 100×10^{-6} for thermoplastic material must be taken into consideration if temperature fluctuations occur. Our standard materials are classified in accordance with the UL (Underwriters Laboratories) system as follows:

- Flammability rating (UL94)
- POM, PP, PA6, PA6.6, and PA12: HB (Horizontal Burning)

Materials

| Chemical properties of the plastics used | | | | | | | | |
|--|---|-----------------------------|-------------|-----|---------|------|--------|-------|
| No. | Chemical substance | Concentration | Temperature | POM | PP | PA 6 | PA 6.6 | PA 12 |
| 1 | Acetone | 100% | 20 °C/50 °C | 1/3 | 1/1 | 1/0 | 1/0 | 1/0 |
| 2 | Formic acid | 98-100% | 20 °C/50 °C | 4/4 | 1/3 | 4/4 | 4/4 | 4/4 |
| 3 | Ammonium hydroxide (spirits of ammonia) | Any | 20 °C/50 °C | 1/2 | 1/1 | 1/0 | 1/0 | 1/0 |
| 4 | Benzine; normal and super unleaded | Commercial | 20 °C/50 °C | 1/1 | 3/4 | 1/1 | 1/1 | 1/1 |
| 5 | Benzene, benzene hydrocarbons | 100% | 20 °C/50 °C | 3/3 | 3/4 | 1/0 | 1/0 | 1/0 |
| 6 | Bleaching lye (12.5% active chlorine) | Aqueous solution 12.5% | 20 °C/50 °C | 4/4 | 3/3 | 4/4 | 4/4 | 3/3 |
| 7 | Brake fluid (DOT4) | Commercial | 20 °C/50 °C | 1/1 | 1/1 | 1/1 | 1/1 | 1/1 |
| 8 | Butanol | Technically pure | 20 °C/50 °C | 1/2 | 1/1 | 1/0 | 1/0 | 1/0 |
| 9 | Chlorine, chlorine water | Commercial | 20 °C/50 °C | 4/4 | 4/4 | 4/4 | 4/4 | 4/4 |
| 10 | Disinfectant phenols | Diluted solution | 20 °C/50 °C | 4/4 | 1/1 | 4/4 | 4/4 | 4/4 |
| 11 | Diesel fuel, diesel oil | Commercial | 20 °C/50 °C | 1/1 | 1/3 | 1/1 | 1/1 | 1/1 |
| 12 | Decalcifier | Aqueous solution~10% | 20 °C/50 °C | 4/4 | 1/1 | 2/3 | 2/3 | 2/3 |
| 13 | Photographic developer (1:100) | Commercial | 20 °C/50 °C | 1/1 | 1/1 | 4/4 | 4/4 | 4/4 |
| 14 | Natural gas (town gas, coal gas) | Commercial | 20 °C/50 °C | 1/1 | 1/1 | 1/1 | 1/1 | 1/1 |
| 15 | Crude oil | Commercial | 20 °C/50 °C | 1/1 | 3/3 | 1/1 | 1/1 | 1/1 |
| 16 | Acetic acid (glacial acetic acid) | 90% | 20 °C/50 °C | 4/4 | 1/2 | 4/4 | 4/4 | 4/4 |
| 17 | Ethyl alcohol | 96% ((tech. pure) | 20 °C/50 °C | 1/2 | 1/1 | 1/0 | 1/0 | 1/0 |
| 18 | Photographic emulsion | Commercial | 20 °C/50 °C | 1/0 | 1/1 | 1/0 | 1/0 | 1/0 |
| 19 | Fruit juices | Commercial | 20 °C/50 °C | 1/1 | 1/1 | 1/1 | 1/1 | 1/1 |
| 20 | Glycerine | Technically pure | 20 °C/50 °C | 1/1 | 1/1 | 1/1 | 1/1 | 1/1 |
| 21 | Glystantin | Commercial | 20 °C/50 °C | 1/1 | 1/1 | 3/3 | 3/3 | 3/3 |
| 22 | Heating oil | Commercial | 20 °C/50 °C | 1/1 | 1/3 | 1/1 | 1/1 | 1/1 |
| 23 | Hydraulic fluid | Commercial | 20 °C/50 °C | 1/0 | 1/3 | 1/1 | 1/1 | 1/1 |
| 24 | Carbon dioxide, carbonic acid | Technically pure, saturated | 20 °C/50 °C | 1/1 | 1/1 | 1/0 | 1/0 | 1/0 |
| 25 | Coolants (based on glycol) | Commercial | 20 °C/50 °C | 1/1 | 1/1 | 3/3 | 1/1 | 1/1 |
| 26 | Methane | Technically pure | 20 °C/50 °C | 1/1 | 1/1 | 1/1 | 1/1 | 1/1 |
| 27 | Methanol | Technically pure | 20 °C/50 °C | 1/1 | 1/1 | 1/1 | 1/1 | 3/3 |
| 28 | Methyl ethyl ketone | 100% | 20 °C/50 °C | 3/3 | 1/3 | 1/0 | 1/0 | 1/1 |
| 29 | Engine oils (HD) | Commercial | 20 °C/50 °C | 1/1 | 1/3 | 1/1 | 1/1 | 1/1 |
| 30 | Sodium hydroxide (lye; caustic soda) | 40% | 20 °C/50 °C | 1/1 | 1/1 | 1/1 | 1/1 | 1/1 |
| 31 | Ozone | Gaseous | 20 °C/50 °C | 4/4 | 3/4 | 3/4 | 3/4 | 3/4 |
| 32 | Propanol | Technically pure | 20 °C/50 °C | 1/1 | 1/1 | 1/1 | 1/1 | 2/2 |
| 33 | Propane (liquefied gas) | Liquid | 20 °C/50 °C | 1/1 | 1/1 | 1/0 | 1/0 | 1/0 |
| 34 | Propene | 96% | 20 °C/50 °C | 1/0 | 1/1 | 1/0 | 1/0 | 1/0 |
| 35 | Rape oil (rape oil methyl ester) | Commercial | 20 °C/50 °C | 1/1 | 2/2 (*) | 1/1 | 1/1 | 1/1 |
| 36 | Hydrochloric acid | Aqueous, 10% | 20 °C/50 °C | 4/4 | 1/1 | 4/4 | 4/4 | 3/3 |
| 37 | Lubricating oil/grease, soft soap | Commercial | 20 °C/50 °C | 1/1 | 1/2 | 1/1 | 1/1 | 1/1 |
| 38 | Sulphuric acid | Aqueous, 10% | 20 °C/50 °C | 4/4 | 1/2 | 3/3 | 3/3 | 2/2 |
| 39 | De-icing salt solution (brine) | Saturated | 20 °C/50 °C | 1/2 | 1/1 | 1/1 | 1/1 | 1/1 |
| 40 | Soap suds (dissolved detergent) | Diluted solution | 20 °C/50 °C | 1/1 | 2/2 (*) | 1/1 | 1/1 | 1/1 |
| 41 | Water (drinking, river, sea) | Technically pure | 20 °C/50 °C | 1/1 | 1/1 | 1/1 | 1/1 | 1/1 |
| 42 | Citric acid | 10% | 20 °C/50 °C | 2/4 | 1/1 | 1/0 | 1/0 | 1/0 |

Explanation of abbreviations:

POM = Acetal copolymer

PP = Polypropylene

PA = Polyamide

0 = No data available/Not possible to make an appropriate statement

1 = Highly stable/suitable (change in dimensions: none or negligible and reversible; no damage even after extended period)

2 = Very stable/suitable (change in dimensions after short period: none or negligible and reversible; little change in dimensions, possibly irreversible change to properties after extended period)

3 = Limited stability (considerable changes to dimensions, possibly irreversible change to properties after extended period)

4 = Unstable/unsuitable (soluble or serious effects after a short period)

(*) Moisture expansion

The specifications in this catalogue are based on tests carried out by the granular material manufacturer. They are intended to serve as guidelines for our customers, but cannot simply be applied to any case in which customers expose these products to demands which fall outside the scope of the tests performed. On no account should this be done without first consulting us.

Our customers must perform their own tests to determine whether our NORMAPLAST® plastic hose connecting components are suitable for the application they are intended to be used in. We will be happy to offer any advice or information required.

Our liability is subject exclusively to our terms of delivery and sale. Special versions can be produced if an appropriate quantity of the component in question is ordered.

Please contact the relevant manufacturer before using a product as a safety component.



Use as a hose connector

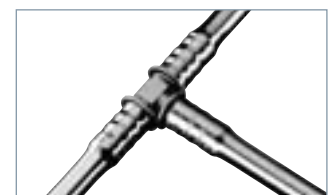

Use as a push-on connector

GES – Straight taper thread connectors

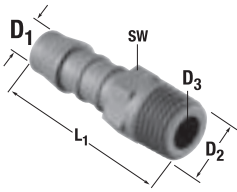

| GES – STRAIGHT TAPER THREAD CONNECTORS | | | | | | | |
|--|---------------------|----------------|-----------------|----------------|------------------|---------------|-----------------------------|
| Nominal size ID hose (in mm) | Designation | D ₁ | D ₂ | D ₃ | L ₁ ~ | SW | Material PA6 Product No. |
| 3 | GES 3 / M 5 | 3 | M 5 cyl | 2.5 | 19.5 | 6 | 0710 8952 003 |
| 4 | GES 4 / M 8 x 1 | 4 | M 8 x 1 con. | 2.5 | 27 | 10 | 0710 8901 004 |
| | GES 4 / M 8 x 1.25 | 4 | M 8 x 1.25 con. | 2.5 | 27 | 10 | 0710 8902 004 |
| | GES 4 / M 10 x 1 | 4 | M 10 x 1 con. | 2.5 | 27 | 10 | 0710 8903 004 |
| | GES 4 / M 12 x 1.5 | 4 | M 12 x 1.5 con. | 2.5 | 32 | 14 | 0710 8904 004 |
| | GES 4 / M 14 x 1.5 | 4 | M 14 x 1.5 con. | 2.5 | 32 | 14 | 0710 8905 004 |
| | GES 4 / R 1/8 | 4 | R 1/8 con. | 2.5 | 27 | 10 | 0710 8910 004 |
| | GES 4 / R 1/4 | 4 | R 1/4 con. | 2.5 | 32 | 14 | 0710 8911 004 |
| | GES 4 / 1/8 NPT | 4 | 1/8 NPT | 2.5 | 29 | 10 | 0710 8917 004 |
| GES 4 / 1/4 NPT | 4 | 1/4 NPT | 2.5 | 35 | 14 | 0710 8918 004 | |
| 5 | GES 5 / M 12 x 1.5 | 5 | M 12 x 1.5 con. | 3 | 36 | 14 | 0710 8904 005 |
| | GES 5 / M 14 x 1.5 | 5 | M 14 x 1.5 con. | 3 | 36 | 14 | 0710 8905 005 |
| | GES 5 / R 1/4 | 5 | R 1/4 con. | 3 | 36 | 14 | 0710 8911 005 |
| | GES 5 / R 1/4 NPT | 5 | R 1/4 NPT | 3 | 39 | 14 | 0710 8918 005 |
| 6 | GES 6 / M 10 x 1 | 6 | M 10 x 1 con. | 4 | 32.5 | 10 | 0710 8903 006 |
| | GES 6 / M 12 x 1.5 | 6 | M 12 x 1.5 con. | 4 | 37.5 | 14 | 0710 8904 006 |
| | GES 6 / M 14 x 1.5 | 6 | M 14 x 1.5 con. | 4 | 36.5 | 14 | 0710 8905 006 |
| | GES 6 / R 1/8 | 6 | R 1/8 con. | 4 | 32.5 | 10 | 0710 8910 006 |
| | GES 6 / R 1/4 | 6 | R 1/4 con. | 4 | 37.5 | 14 | 0710 8911 006 |
| | GES 6 / R 3/8 | 6 | R 3/8 con. | 4 | 39 | 17 | 0710 8912 006 |
| | GES 6 / 1/8 NPT | 6 | 1/8 NPT | 4 | 34.5 | 10 | 0710 8917 006 |
| | GES 6 / 1/4 NPT | 6 | 1/4 NPT | 4 | 40.5 | 14 | 0710 8918 006 |
| 8 | GES 8 / M 10 x 1 | 8 | M 10 x 1 con. | 5.6 | 38 | 14 | 0710 8903 008 |
| | GES 8 / M 12 x 1.5 | 8 | M 12 x 1.5 con. | 5.6 | 41 | 14 | 0710 8904 008 |
| | GES 8 / M 14 x 1.5 | 8 | M 14 x 1.5 con. | 5.6 | 41 | 14 | 0710 8905 008 |
| | GES 8 / M 18 x 1.5 | 8 | M 18 x 1.5 con. | 5.6 | 49 | 22 | 0710 8907 008 |
| | GES 8 / M 22 x 1.5 | 8 | M 22 x 1.5 con. | 5.6 | 49 | 22 | 0710 8949 008 |
| | GES 8 / M 26 x 1.5 | 8 | M 26 x 1.5 con. | 5.6 | 58 | 27 | 0710 8908 008 |
| | GES 8 / R 1/8 | 8 | R 1/8 con. | 5.6 | 38 | 14 | 0710 8910 008 |
| | GES 8 / R 1/4 | 8 | R 1/4 con. | 5.6 | 41 | 14 | 0710 8911 008 |
| | GES 8 / R 3/8 | 8 | R 3/8 con. | 5.6 | 41 | 17 | 0710 8912 008 |
| | GES 8 / R 1/2 | 8 | R 1/2 con. | 5.6 | 49 | 22 | 0710 8913 008 |
| GES 8 / 1/4 NPT | 8 | 1/4 NPT | 5.6 | 44 | 14 | 0710 8918 008 | |
| 10 | GES 10 / M 12 x 1.5 | 10 | M 12 x 1.5 con. | 7 | 43.5 | 14 | 0710 8904 010 |
| | GES 10 / M 14 x 1.5 | 10 | M 14 x 1.5 con. | 7 | 43.5 | 14 | 0710 8905 010 |
| | GES 10 / M 16 x 1.5 | 10 | M 16 x 1.5 con. | 7 | 43.5 | 17 | 0710 8906 010 |
| | GES 10 / R 1/4 | 10 | R 1/4 con. | 7 | 43.5 | 14 | 0710 8911 010 |
| | GES 10 / R 3/8 | 10 | R 3/8 con. | 7 | 43.5 | 17 | 0710 8912 010 |
| | GES 10 / 1/4 NPT | 10 | 1/4 NPT | 7 | 46.5 | 14 | 0710 8918 010 |
| | GES 10 / 3/8 NPT | 10 | 3/8 NPT | 7 | 46.5 | 17 | 0710 8919 010 |
| 12 | GES 12 / M 16 x 1.5 | 12 | M 16 x 1.5 con. | 8.6 | 45.5 | 17 | 0710 8906 012 |
| | GES 12 / M 18 x 1.5 | 12 | M 18 x 1.5 con. | 8.6 | 54 | 22 | 0710 8907 012 |
| | GES 12 / M 22 x 1.5 | 12 | M 22 x 1.5 con. | 8.6 | 54 | 22 | 0710 8949 012 |
| | GES 12 / M 26 x 1.5 | 12 | M 26 x 1.5 con. | 8.6 | 58 | 27 | 0710 8909 012 |
| | GES 12 / R 3/8 | 12 | R 3/8 con. | 8.6 | 45.5 | 17 | 0710 8912 012 |
| | GES 12 / R 1/2 | 12 | R 1/2 con. | 8.6 | 54 | 22 | 0710 8913 012 |
| | GES 12 / 3/8 NPT | 12 | 3/8 NPT | 8.6 | 48 | 17 | 0710 8919 012 |
| 14 | GES 14 / M 20 x 1.5 | 14 | M 20 x 1.5 con. | 10 | 56 | 22 | 0710 8908 014 |
| | GES 14 / R 3/8 | 14 | R 3/8 con. | 10 | 56 | 17 | 0710 8912 014 |
| | GES 14 / R 1/2 | 14 | R 1/2 con. | 10 | 56 | 22 | 0710 8913 014 |
| | GES 14 / R 1/2 NPT | 14 | R 1/2 NPT | 10 | 58 | 22 | 0710 8920 014 |
| 16 | GES 16 / M 26 x 1.5 | 16 | M 26 x 1.5 con. | 12 | 58 | 27 | 0710 8909 016 |
| | GES 16 / R 1/2 | 16 | R 1/2 con. | 12 | 58 | 22 | 0710 8913 016 |
| | GES 16 / R 3/4 | 16 | R 3/4 con. | 12 | 58 | 27 | 0710 8914 016 |
| 19 | GES 19 / M 26 x 1.5 | 19 | M 26 x 1.5 con. | 15 | 58 | 27 | 0710 8909 019 |
| | GES 19 / R 3/4 | 19 | R 3/4 con. | 15 | 58 | 27 | 0710 8914 019 |
| 25 | GES 25 / R 1 | 25 | R 1 con. | 21 | 69 | 32 | 0710 8915 025 |

BST – Blanking plugs with screw-in thread

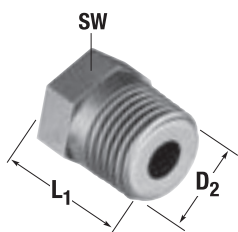

| BST – BLANKING PLUGS WITH SCREW-IN THREAD | | | | |
|---|-----------------|------------------|----|-----------------------------|
| Designation | D ₂ | L ₁ ~ | SW | Material PA6 Product No. |
| BST M 8 x 1 | M 8 x 1 con. | 13 | 10 | 0711 8901 000 |
| BST M 10 x 1 | M 10 x 1 con. | 13.5 | 10 | 0711 8903 000 |
| BST M 12 x 1.5 | M 12 x 1.5 con. | 17.5 | 14 | 0711 8904 000 |
| BST M 14 x 1.5 | M 14 x 1.5 con. | 17.5 | 14 | 0711 8905 000 |
| BST M 18 x 1.5 | M 18 x 1.5 con. | 26.5 | 22 | 0711 8907 000 |
| BST M 20 x 1.5 | M 20 x 1.5 con. | 25 | 22 | 0711 8908 000 |
| BST M 26 x 1.5 | M 26 x 1.5 con. | 26.5 | 22 | 0711 8909 000 |
| BST R 1/8 | R 1/8 con. | 26 | 22 | 0711 8910 000 |
| BST R 1/4 | R 1/4 con. | 12.5 | 10 | 0711 8911 000 |
| BST R 3/8 | R 3/8 con. | 17.5 | 14 | 0711 8912 000 |
| BST R 1/2 | R 1/2 con. | 27 | 17 | 0711 8913 000 |
| BST 1/8 NPT | 1/8 NPT | 27.5 | 22 | 0711 8917 000 |
| BST 1/4 NPT | 1/4 NPT | 14 | 10 | 0711 8918 000 |
| BST M 22 x 1.5 | M 22 x 1.5 con. | 20.5 | 14 | 0711 8949 000 |

TES – T-taper thread connectors

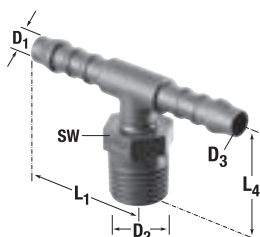

| TES – T-TAPER THREAD CONNECTORS | | | | | | | | |
|------------------------------------|--------------------|----------------|-----------------|----------------|------------------|------------------|----|-----------------------------|
| Nominal size ID hose (in mm) | Designation | D ₁ | D ₂ | D ₃ | L ₁ ~ | L ₄ ~ | SW | Material PA6 Product No. |
| 4 | TES 4 / M 8 x 1 | 4 | M 8 x 1 con. | 2.5 | 21 | 18 | 10 | 0720 8901 004 |
| | TES 4 / M 10 x 1 | 4 | M 10 x 1 con. | 2.5 | 21 | 18 | 10 | 0720 8903 004 |
| | TES 4 / M 12 x 1.5 | 4 | M 12 x 1.5 con. | 2.9 | 21 | 23 | 14 | 0720 8904 004 |
| | TES 4 / R 1/8 | 4 | R 1/8 con. | 2.5 | 21 | 18 | 10 | 0720 8910 004 |
| | TES 4 / R 1/4 | 4 | R 1/4 con. | 2.5 | 21 | 23 | 14 | 0720 8911 004 |
| | TES 4 / 1/8 NPT | 4 | 1/8 NPT | 2.5 | 21 | 20 | 10 | 0720 8917 004 |
| | TES 4 / 1/4 NPT | 4 | 1/4 NPT | 2.5 | 21 | 26 | 14 | 0720 8918 004 |
| 6 | TES 6 / M 10 x 1 | 6 | M 10 x 1 con. | 4 | 28.5 | 21 | 10 | 0720 8903 006 |
| | TES 6 / M 12 x 1.5 | 6 | M 12 x 1.5 con. | 4 | 28.5 | 26 | 14 | 0720 8904 006 |
| | TES 6 / R 1/8 | 6 | R 1/8 con. | 4 | 28.5 | 21 | 10 | 0720 8910 006 |
| | TES 6 / R 1/4 | 6 | R 1/4 con. | 4 | 28.5 | 26 | 14 | 0720 8911 006 |
| | TES 6 / 1/8 NPT | 6 | 1/8 NPT | 4 | 28.5 | 23 | 10 | 0720 8917 006 |
| | TES 6 / 1/4 NPT | 6 | 1/4 NPT | 4 | 28.5 | 29 | 14 | 0720 8918 006 |
| 8 | TES 8 / M 12 x 1.5 | 8 | M 12 x 1.5 con. | 5.6 | 33 | 27.5 | 14 | 0720 8904 008 |
| | TES 8 / M 14 x 1.5 | 8 | M 14 x 1.5 con. | 5.6 | 33 | 27.5 | 14 | 0720 8905 008 |
| | TES 8 / R 1/4 | 8 | R 1/4 con. | 5.6 | 33 | 27.5 | 14 | 0720 8911 008 |
| | TES 8 / 1/4NPT | 8 | 1/4NPT | 5.6 | 33 | 30.5 | 14 | 0720 8918 008 |
| 10 | TES 10 / R 3/8 | 10 | R 3/8 con. | 7 | 35.5 | 30 | 17 | 0720 8912 010 |

WES – Elbow taper thread connectors

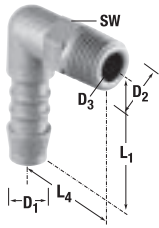

| WES – ELBOW TAPER THREAD CONNECTORS | | | | | | | | |
|-------------------------------------|---------------------|----------------|-----------------|----------------|------------------|------------------|---------------|--------------------------|
| Nominal size ID hose (in mm) | Designation | D ₁ | D ₂ | D ₃ | L ₁ ~ | L ₄ ~ | SW | Material PA6 Product No. |
| 3 | WES 3 / M 5 cyl. | 3 | M 5 cyl. | 2.5 | 12.5 | 12.5 | 6 | 0730 8952 003 |
| 4 | WES 4 / M 8 x 1 | 4 | M 8 x 1 con. | 2.7 | 21 | 16 | 10 | 0730 8901 004 |
| | WES 4 / M 10 x 1 | 4 | M 10 x 1 con. | 2.7 | 21 | 16 | 10 | 0730 8903 004 |
| | WES 4 / M 12 x 1.5 | 4 | M 12 x 1.5 con. | 2.7 | 21 | 25 | 14 | 0730 8904 004 |
| | WES 4 / M 14 x 1.5 | 4 | M 14 x 1.5 con. | 2.7 | 21 | 25 | 14 | 0730 8905 004 |
| | WES 4 / R 1/8 | 4 | R 1/8 con. | 2.7 | 21 | 16 | 10 | 0730 8910 004 |
| | WES 4 / R 1/4 | 4 | R 1/4 con. | 2.7 | 21 | 25 | 14 | 0730 8911 004 |
| | WES 4 / 1/8 NPT | 4 | 1/8 NPT | 2.7 | 21 | 18 | 10 | 0730 8917 004 |
| | WES 4 / 1/4 NPT | 4 | 1/4 NPT | 2.7 | 21 | 28 | 14 | 0730 8918 004 |
| 6 | WES 6 / M 10 x 1 | 6 | M 10 x 1 con. | 4 | 28.5 | 21 | 10 | 0730 8903 006 |
| | WES 6 / M 12 x 1.5 | 6 | M 12 x 1.5 con. | 4 | 28.5 | 26 | 14 | 0730 8904 006 |
| | WES 6 / R 1/8 | 6 | R 1/8 con. | 4 | 28.5 | 21 | 10 | 0730 8910 006 |
| | WES 6 / R 1/4 | 6 | R 1/4 con. | 4 | 28.5 | 26 | 14 | 0730 8911 006 |
| | WES 6 / R 3/8 | 6 | R 3/8 con. | 4 | 28.5 | 27 | 17 | 0730 8912 006 |
| | WES 6 / 1/8 NPT | 6 | 1/8 NPT | 4 | 28.5 | 23 | 10 | 0730 8917 006 |
| | WES 6 / 1/4 NPT | 6 | 1/4 NPT | 4 | 28.5 | 29 | 14 | 0730 8918 006 |
| 8 | WES 8 / M 10 x 1 | 8 | M 10 x 1 con. | 5.6 | 33 | 23.5 | 14 | 0730 8903 008 |
| | WES 8 / M 12 x 1.5 | 8 | M 12 x 1.5 con. | 5.6 | 33 | 27.5 | 14 | 0730 8904 008 |
| | WES 8 / M 14 x 1.5 | 8 | M 14 x 1.5 con. | 5.6 | 33 | 27.5 | 14 | 0730 8905 008 |
| | WES 8 / M 16 x 1.5 | 8 | M 16 x 1.5 con. | 5.6 | 36 | 27.5 | 17 | 0730 8906 008 |
| | WES 8 / M 18 x 1.5 | 8 | M 18 x 1.5 con. | 5.6 | 36 | 36 | 19 | 0730 8907 008 |
| | WES 8 / M 22 x 1.5 | 8 | M 22 x 1.5 con. | 5.6 | 36 | 36 | 22 | 0730 8949 008 |
| | WES 8 / R 1/8 | 8 | R 1/8 con. | 5.6 | 33 | 23 | 14 | 0730 8910 008 |
| | WES 8 / R 1/4 | 8 | R 1/4 con. | 5.6 | 33 | 27.5 | 14 | 0730 8911 008 |
| | WES 8 / R 3/8 | 8 | R 3/8 con. | 5.6 | 36 | 31 | 17 | 0730 8912 008 |
| | WES 8 / R 1/2 | 8 | R 1/2 con. | 5.6 | 36 | 36 | 22 | 0730 8913 008 |
| WES 8 / 1/4 NPT | 8 | 1/4 NPT | 5.6 | 33 | 30.5 | 14 | 0730 8918 008 | |
| 10 | WES 10 / M 14 x 1.5 | 10 | M 14 x 1.5 con. | 7 | 38 | 30 | 14 | 0730 8905 010 |
| | WES 10 / R 1/4 | 10 | R 1/4 | 7 | 38 | 30 | 14 | 0730 8911 010 |
| | WES 10 / R 3/8 | 10 | R 3/8 | 7 | 38 | 30 | 17 | 0730 8912 010 |
| | WES 10 / 1/2 NPT | 10 | 1/2 NPT | 7 | 38 | 38 | 22 | 0730 8920 010 |
| 12 | WES 12 / M 16 x 1.5 | 12 | M 16 x 1.5 con. | 8.6 | 40.5 | 30 | 17 | 0730 8906 012 |
| | WES 12 / M 18 x 1.5 | 12 | M 18 x 1.5 con. | 8.6 | 40.5 | 36 | 19 | 0730 8907 012 |
| | WES 12 / M 22 x 1.5 | 12 | M 22 x 1.5 con. | 8.6 | 40.5 | 36 | 22 | 0730 8949 012 |
| | WES 12 / M 26 x 1.5 | 12 | M 26 x 1.5 con. | 8.6 | 40.5 | 36 | 22 | 0730 8909 012 |
| | WES 12 / R 3/8 | 12 | R 3/8 | 8.6 | 40.5 | 31 | 17 | 0730 8912 012 |
| | WES 12 / R 1/2 | 12 | R 1/2 | 8.6 | 40.5 | 36 | 22 | 0730 8913 012 |
| | WES 12 / 3/8 NPT | 12 | 3/8 NPT | 8.6 | 40.5 | 31 | 19 | 0730 8919 012 |
| 19 | WES 19 / M 24 x 2 | 19 | M 24 x 2 con. | 15 | 45 | 42.8 | 27 | 0730 8953 019 |
| | WES 19 / R 3/4 | 19 | R 3/4 con. | 15 | 45.5 | 42.8 | 27 | 0730 8914 019 |
| 25 | WES 25 / R 1 | 25 | R 1 con. | 21 | 60 | 49 | 32 | 0730 8915 025 |

GS – Straight push-on connectors

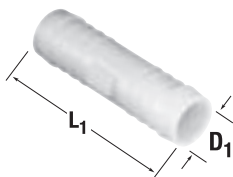

| GS – STRAIGHT PUSH-ON CONNECTORS | | | | | |
|----------------------------------|-------------|----------------|----------------|------------------|--------------------------|
| Nominal size ID hose (in mm) | Designation | D ₁ | D ₂ | L ₁ ~ | Material POM Product No. |
| 3 | GS 3 | 3 | 2.5 | 25 | 0750 8900 003 |
| 4 | GS 4 | 4 | 2.7 | 35 | 0750 8900 004 |
| 5 | GS 5 | 5 | 3 | 45 | 0750 8900 005 |
| 6 | GS 6 | 6 | 4 | 49 | 0750 8900 006 |
| 8 | GS 8 | 8 | 5.6 | 56 | 0750 8900 008 |
| 10 | GS 10 | 10 | 7 | 63 | 0750 8900 010 |
| 12 | GS 12 | 12 | 8.6 | 66.5 | 0750 8900 012 |
| 13 | GS 13 | 13 | 8.6 | 73 | 0750 8900 013 |
| 14 | GS 14 | 14 | 10 | 79 | 0750 8900 014 |
| 16 | GS 16 | 16 | 12 | 75 | 0750 8900 016 |
| 19 | GS 19 | 19 | 15 | 76 | 0750 8900 019 |
| 25 | GS 25 | 25 | 21 | 95 | 0750 8900 025 |

Additional materials available on request



Refer to page 188 and 189

GRS – Reducing straight push-on connectors

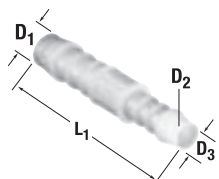

| GRS – REDUCING STRAIGHT PUSH-ON CONNECTORS | | | | | | |
|--|-------------|----------------|----------------|----------------|------------------|--------------------------|
| Nominal size ID hose (in mm) | Designation | D ₁ | D ₂ | D ₃ | L ₁ ~ | Material POM Product No. |
| 4 - 3 | GRS 4 - 3 | 4 | 2.5 | 3 | 30 | 0751 8904 003 |
| 5 - 4 | GRS 5 - 4 | 5 | 2.7 | 3 | 41 | 0751 8905 004 |
| 6 - 4 | GRS 6 - 4 | 6 | 2.7 | 4 | 42.5 | 0751 8906 004 |
| 8 - 4 | GRS 8 - 4 | 8 | 2.7 | 4 | 48 | 0751 8908 004 |
| 8 - 6 | GRS 8 - 6 | 8 | 4 | 6 | 54 | 0751 8908 006 |
| 10 - 6 | GRS 10 - 6 | 10 | 4 | 6 | 58 | 0751 8910 006 |
| 10 - 8 | GRS 10 - 8 | 10 | 5.6 | 8 | 60.5 | 0751 8910 008 |
| 12 - 8 | GRS 12 - 8 | 12 | 5.6 | 8 | 62.5 | 0751 8912 008 |
| 12 - 10 | GRS 12 - 10 | 12 | 7 | 10 | 64 | 0751 8912 010 |

Additional materials available on request



Refer to page 189

TS – Equal T push-on connectors

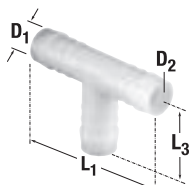

| TS – EQUAL T PUSH-ON CONNECTORS | | | | | | |
|---------------------------------|-------------|----------------|----------------|------------------|------------------|--------------------------|
| Nominal size ID hose (in mm) | Designation | D ₁ | D ₂ | L ₁ ~ | L ₃ ~ | Material POM Product No. |
| 3 | TS 3 | 3 | 2.5 | 25 | 12.5 | 0760 8900 003 |
| 4 | TS 4 | 4 | 2.7 | 35 | 19.5 | 0760 8900 004 |
| 5 | TS 5 | 5 | 3 | 42 | 22 | 0760 8900 005 |
| 6 | TS 6 | 6 | 4 | 50 | 26 | 0760 8900 006 |
| 7 | TS 7 | 7 | 5 | 50 | 26 | 0760 8900 007 |
| 8 | TS 8 | 8 | 5.6 | 58 | 30 | 0760 8900 008 |
| 10 | TS 10 | 10 | 7 | 62.5 | 33.5 | 0760 8900 010 |
| 12 | TS 12 | 12 | 8.6 | 69 | 36 | 0760 8900 012 |
| 13 | TS 13 | 13 | 8.6 | 68 | 36 | 0760 8900 013 |
| 14 | TS 14 | 14 | 10 | 77.5 | 41.5 | 0760 8900 014 |
| 15 | TS 15 | 15 | 11 | 79.5 | 43.5 | 0760 8900 015 |
| 16 | TS 16 | 16 | 12 | 81 | 45 | 0760 8900 016 |
| 19 | TS 19 | 19 | 15 | 85 | 45 | 0760 8900 019 |
| 25 | TS 25 | 25 | 21 | 105 | 52.5 | 0760 8900 025 |

Additional materials available on request



Refer to page 188 and 189

KS – Cross push-on connectors

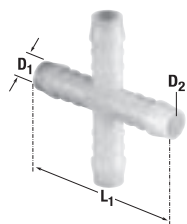

| KS – CROSS PUSH-ON CONNECTORS | | | | | |
|-------------------------------|-------------|----------------|----------------|------------------|--------------------------|
| Nominal size ID hose (in mm) | Designation | D ₁ | D ₂ | L ₁ ~ | Material POM Product No. |
| 4 | KS 4 | 4 | 2.9 | 39 | 0772 8900 004 |
| 5 | KS 5 | 5 | 3 | 48 | 0772 8900 005 |
| 6 | KS 6 | 6 | 4 | 48 | 0772 8900 006 |
| 12 | KS 12 | 12 | 8.6 | 69 | 0772 8900 012 |

Additional materials available on request

TRS – Reducing T push-on connectors

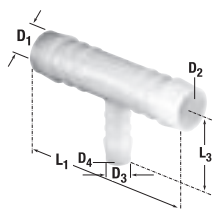

| TRS – REDUCING T PUSH-ON CONNECTORS | | | | | | | | |
|-------------------------------------|------------------|----------------|----------------|----------------|----------------|------------------|------------------|--------------------------|
| Nominal size ID hose (in mm) | Designation | D ₁ | D ₂ | D ₃ | D ₄ | L ₁ ~ | L ₂ ~ | Material POM Product No. |
| 3 - 4 - 3 | TRS 3 - 4 - 3 | 3 | 2.5 | 4 | 2.5 | 25 | 17.5 | 0761 8903 004 |
| 4 - 6 - 4 | TRS 4 - 6 - 4 | 4 | 2.7 | 6 | 4 | 37 | 24 | 0761 8904 006 |
| 6 - 4 - 6 | TRS 6 - 4 - 6 | 6 | 4 | 4 | 2.5 | 49 | 20.5 | 0761 8906 004 |
| 8 - 4 - 8 | TRS 8 - 4 - 8 | 8 | 5.6 | 4 | 2.5 | 56 | 22 | 0761 8908 004 |
| 8 - 6 - 8 | TRS 8 - 6 - 8 | 8 | 5.6 | 6 | 4 | 56 | 28 | 0761 8908 006 |
| 8 - 12 - 8 | TRS 8 - 12 - 8 | 8 | 5.6 | 12 | 8.6 | 57 | 34 | 0761 8908 012 |
| 10 - 6 - 10 | TRS 10 - 6 - 10 | 10 | 7 | 6 | 4 | 62 | 28 | 0761 8910 006 |
| 10 - 8 - 10 | TRS 10 - 8 - 10 | 10 | 7 | 8 | 5.6 | 62 | 31 | 0761 8910 008 |
| 10 - 13 - 10 | TRS 10 - 13 - 10 | 10 | 7 | 13 | 8.6 | 64 | 38 | 0761 8910 013 |
| 12 - 6 - 12 | TRS 12 - 6 - 12 | 12 | 8.6 | 6 | 4 | 69 | 29 | 0761 8912 006 |
| 12 - 8 - 12 | TRS 12 - 8 - 12 | 12 | 8.6 | 8 | 5.6 | 69 | 31 | 0761 8912 008 |
| 12 - 10 - 12 | TRS 12 - 10 - 12 | 12 | 8.6 | 10 | 7 | 69 | 33 | 0761 8912 010 |
| 15 - 6 - 15 | TRS 15 - 6 - 15 | 15 | 11 | 6 | 4 | 78 | 28 | 0761 8915 006 |
| 15 - 8 - 15 | TRS 15 - 8 - 15 | 15 | 11 | 8 | 5.6 | 79 | 33 | 0761 8915 008 |
| 18 - 10 - 18 | TRS 18 - 10 - 18 | 18 | 14 | 10 | 7 | 79 | 36 | 0761 8918 010 |
| 18 - 15 - 18 | TRS 18 - 15 - 18 | 18 | 14 | 15 | 11 | 80 | 44 | 0761 8918 015 |

Additional materials available on request

YRS – Reducing Y push-on connectors

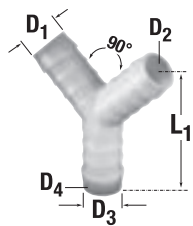

| YRS – REDUCING Y PUSH-ON CONNECTORS | | | | | | | |
|-------------------------------------|---------------|----------------|----------------|----------------|----------------|------------------|--------------------------|
| Nominal size ID hose (in mm) | Designation | D ₁ | D ₂ | D ₃ | D ₄ | L ₁ ~ | Material POM Product No. |
| 4 - 6 - 4 | YRS 4 - 6 - 4 | 4 | 2.7 | 6 | 4 | 35 | 0771 8904 006 |
| 6 - 8 - 6 | YRS 6 - 8 - 6 | 6 | 4 | 8 | 5.6 | 49 | 0771 8906 008 |

Additional materials available on request

WS – Elbow push-on connectors

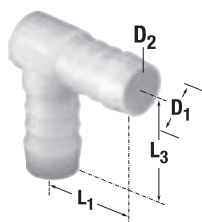

| WS – ELBOW PUSH-ON CONNECTORS | | | | | | |
|-------------------------------|-------------|----------------|----------------|------------------|------------------|--------------------------|
| Nominal size ID hose (in mm) | Designation | D ₁ | D ₂ | L ₁ ~ | L ₃ ~ | Material POM Product No. |
| 3 | WS 3 | 3 | 2.5 | 12.5 | 12.5 | 0762 8900 003 |
| 4 | WS 4 | 4 | 2.5 | 17.5 | 19.5 | 0762 8900 004 |
| 5 | WS 5 | 5 | 3 | 21 | 22 | 0762 8900 005 |
| 6 | WS 6 | 6 | 4 | 25 | 26 | 0762 8900 006 |
| 8 | WS 8 | 8 | 5.6 | 29 | 30 | 0762 8900 008 |
| 10 | WS 10 | 10 | 7 | 31 | 33.5 | 0762 8900 010 |
| 12 | WS 12 | 12 | 8.6 | 34.5 | 36 | 0762 8900 012 |
| 13 | WS 13 | 13 | 8.6 | 36.5 | 38.5 | 0762 8900 013 |
| 14 | WS 14 | 14 | 10 | 38.5 | 41.5 | 0762 8900 014 |
| 15 | WS 15 | 15 | 11 | 40 | 43.5 | 0762 8900 015 |
| 16 | WS 16 | 16 | 12 | 40.5 | 45 | 0762 8900 016 |
| 19 | WS 19 | 19 | 15 | 43.5 | 46 | 0762 8900 019 |
| 25 | WS 25 | 25 | 21 | 52.5 | 52.5 | 0762 8900 025 |

Additional materials available on request

YS – Equal Y push-on connectors

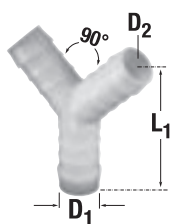

| YS – EQUAL Y PUSH-ON CONNECTORS | | | | | |
|---------------------------------|-------------|----------------|----------------|------------------|--------------------------|
| Nominal size ID hose (in mm) | Designation | D ₁ | D ₂ | L ₁ ~ | Material POM Product No. |
| 3 | YS 3 | 3 | 2.5 | 21 | 0770 8900 003 |
| 4 | YS 4 | 4 | 2.5 | 25.5 | 0770 8900 004 |
| 5 | YS 5 | 5 | 3 | 43 | 0770 8900 005 |
| 6 | YS 6 | 6 | 4 | 44 | 0770 8900 006 |
| 8 | YS 8 | 8 | 5.6 | 51 | 0770 8900 008 |
| 10 | YS 10 | 10 | 7 | 54 | 0770 8900 010 |
| 12 | YS 12 | 12 | 8.6 | 64 | 0770 8900 012 |
| 13 | YS 13 | 13 | 9 | 65 | 0770 8900 013 |
| 14 | YS 14 | 14 | 10 | 65 | 0770 8900 014 |
| 16 | YS 16 | 16 | 12 | 67 | 0770 8900 016 |
| 19 | YS 19 | 19 | 15 | 72 | 0770 8900 019 |

Additional materials available on request



Refer to page 189

NORMAPLAST®

GN – Straight plastic pipe connectors

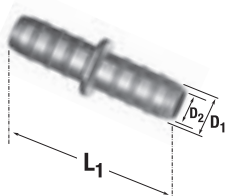

| GN – STRAIGHT PLASTIC PIPE CONNECTORS | | | | | | | |
|---------------------------------------|-------------|----------------|----------------|------------------|---------------------------------|---------------------------------|---------------------------------|
| Nominal size ID PA tube (in mm) | Designation | D ₁ | D ₂ | L ₁ ~ | Material PA6 -GF30* Product No. | Material PA12-GF20* Product No. | Material PA12-GF30* Product No. |
| 6 | GN 6 | 6.4 | 4.75 | 45 | | | 0750 8200 006 |
| 8 | GN 8 | 9.2 | 6.8 | 46 | 0750 8074 008 | | |
| 10 | GN 10 | 11 | 8 | 46 | 0750 8300 010 | | 0750 8200 010 |
| 15 | GN 15 | 16.9 | 12 | 32 | | 0750 8001 015 | |
| 19 | GN 19 | 21 | 16 | 39 | | 0750 8001 019 | |
| 27 | GN 27 | 29 | 24 | 42 | | 0750 8001 027 | |
| 27 - 19 | GRN 27 - 19 | 29 - 21 | 24 - 16 | 44 | | 0751 8045 000 | |

* Glass fiber content

TN – T plastic pipe connectors

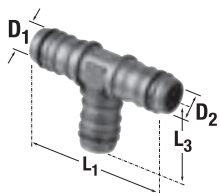

| TN – T PLASTIC PIPE CONNECTORS | | | | | | | | |
|---------------------------------|-------------|----------------|----------------|------------------|------------------|---------------------------------|---------------------------------|---------------------------------|
| Nominal size ID PA tube (in mm) | Designation | D ₁ | D ₂ | L ₁ ~ | L ₃ ~ | Material PA6 -GF30* Product No. | Material PA66-GF30* Product No. | Material PA12-GF30* Product No. |
| 4 | TN 4 | 4.6 | 2.5 | 43 | 23 | 0760 8129 004 | | |
| 6 | TN 6 | 6.4 | 4.75 | 56.5 | 28.5 | 0760 8202 006 | 0760 8203 006 | 0760 8200 006 |
| 8 | TN 8 | 9.2 | 6.8 | 58 | 29 | 0760 8112 008 | | 0760 8200 008 |
| 10 | TN 10 | 11 | 8 | 60 | 30 | | | 0760 8200 010 |
| 15 | TN 15 | 16.4 | 12 | 72 | 36 | | | 0760 8200 015 |
| 19 | TN 19 | 18.9 | 16 | 65 | 32.5 | | | 0760 8201 019 |
| 15-8-15 | TN 15-8-15 | 16.4-8.9-16.4 | 12-6-12 | 72 | 35 | | | 0761 8052 000 |
| 15-12-15 | TN 15-12-15 | 16.4-13.5-16.4 | 12-10.5-12 | 72 | 35.5 | | | 0761 8015 012 |

* Glass fiber content

WN – Elbow plastic pipe connectors

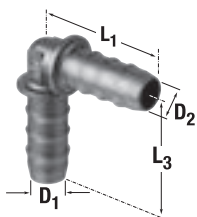

| WN – ELBOW PLASTIC PIPE CONNECTORS | | | | | | | | |
|------------------------------------|-------------|----------------|----------------|------------------|------------------|---------------------------------|---------------------------------|---------------------------------|
| Nominal size ID PA tube (in mm) | Designation | D ₁ | D ₂ | L ₁ ~ | L ₃ ~ | Material PA6 -GF30* Product No. | Material PA66-GF30* Product No. | Material PA12-GF30* Product No. |
| 6 | WN 6 | 6.4 | 4.75 | 28 | 28 | | 0762 8205 006 | 0762 8200 006 |
| 8 | WN 8 | 9.2 | 6.8 | 29 | 29 | 0762 8067 008 | | 0762 8200 008 |
| 10 | WN 10 | 11 | 8 | 30 | 30 | 0762 8201 010 | | 0762 8200 010 |
| 19 | WN 19 | 18.9 | 16 | 32 | 32 | | | 0762 8200 019 |

* Glass fiber content

YN – Y plastic pipe connectors



| YN – Y PLASTIC PIPE CONNECTORS | | | | | | | |
|---------------------------------|-------------|----------------|----------------|------------------|---------------------------------|---------------------------------|---------------------------------|
| Nominal size ID PA tube (in mm) | Designation | D ₁ | D ₂ | L ₁ ~ | Material PA66-GF30* Product No. | Material PA12-GF20* Product No. | Material PA12-GF30* Product No. |
| 8 | YN 8 | 8.4 | 5.8 | 50.5 | 0770 8203 008 | | 0770 8200 008 |
| 10 | YN 10 | 11 | 8 | 80 | | | 0770 8200 010 |
| 15 | YN 15 | 14.9 | 12 | 49.3 | | | 0770 8200 015 |
| 19 | YN 19 | 18.9 | 16 | 85 | | 0770 8201 019 | |

* Glass fiber content

EG – Straight compression connectors



| EG – STRAIGHT COMPRESSION CONNECTORS | | | | | | | |
|--------------------------------------|------------------|----------------|----------------|------------------|----|---------------|---------------------------------|
| Nominal size ID PA tube (in mm) | Designation | D ₁ | D ₂ | L ₁ ~ | SW | Diameter | Material PA12-GF30* Product No. |
| 6 | EG 6 x 1-R 1/8 | 6 x 1 | R 1/8 con. | 25 | 13 | 6 x 1-R 1/8 | 0780 8900 001 |
| | EG 6 x 1-R 1/4 | 6 x 1 | R 1/4 con. | 31 | 17 | 6 x 1-R 1/4 | 0780 8900 002 |
| | EG 6 x 1-M10 x 1 | 6 x 1 | M10 x 1 con. | 25 | 13 | 6 x 1-M10 x 1 | 0780 8900 003 |
| 8 | EG 8 x 1-R 1/8 | 8 x 1 | R 1/8 con. | 25 | 13 | 8 x 1-R 1/8 | 0780 8900 021 |
| | EG 8 x 1-R 1/4 | 8 x 1 | R 1/4 con. | 31 | 17 | 8 x 1-R 1/4 | 0780 8900 022 |
| | EG 8 x 1-M10 x 1 | 8 x 1 | M10 x 1 con. | 25 | 13 | 8 x 1-M10 x 1 | 0780 8900 023 |

* Glass fiber content

EWS – Swivel elbow compression connectors



| EWS – SWIVEL ELBOW COMPRESSION CONNECTORS | | | | | | | | |
|---|-------------------|----------------|----------------|------------------|------------------|------------------|----|--------------------------------|
| Nominal size ID PA tube (in mm) | Designation | D ₁ | D ₂ | L ₁ ~ | L ₂ ~ | L ₃ ~ | SW | Material PA6-GF30* Product No. |
| 6 | EWS 6 x 1-R 1/8 | 6 x 1 | R 1/8 | 14 | 21 | 30 | 13 | 0780 8901 001 |
| | EWS 6 x 1-R 1/4 | 6 x 1 | R 1/4 | 15 | 23 | 33.5 | 17 | 0780 8901 002 |
| | EWS 6 x 1-M10 x 1 | 6 x 1 | M10 x 1 | 14 | 21 | 30 | 13 | 0780 8901 003 |
| 8 | EWS 8 x 1-R 1/8 | 8 x 1 | R 1/8 | 14 | 21 | 30 | 13 | 0780 8901 021 |
| | EWS 8 x 1-R 1/4 | 8 x 1 | R 1/4 | 15 | 23 | 33.5 | 17 | 0780 8901 022 |
| | EWS 8 x 1-M10 x 1 | 8 x 1 | M10 x 1 | 14 | 21 | 30 | 13 | 0780 8901 023 |

* Glass fiber content

ET – T compression connectors



| ET – T COMPRESSION CONNECTORS | | | | | | |
|---------------------------------|------------------|----------------|----------------|------------------|------------------|--------------------------------|
| Nominal size ID PA tube (in mm) | Designation | D ₁ | D ₂ | L ₁ ~ | L ₂ ~ | Material PA6-GF30* Product No. |
| 6 | ET 6 x 1-R 1/8 | 6 x 1 | R 1/8 con. | 19 | 23 | 0780 8904 001 |
| | ET 6 x 1-R 1/4 | 6 x 1 | R 1/4 con. | 23 | 23 | 0780 8904 002 |
| | ET 6 x 1-M10 x 1 | 6 x 1 | M10 x 1 con. | 19 | 23 | 0780 8904 003 |
| 8 | ET 8 x 1-R 1/8 | 8 x 1 | R 1/8 con. | 19 | 23 | 0780 8904 021 |
| | ET 8 x 1-R 1/4 | 8 x 1 | R 1/4 con. | 23 | 23 | 0780 8904 022 |
| | ET 8 x 1-M10 x 1 | 8 x 1 | M10 x 1 con. | 19 | 23 | 0780 8904 023 |

* Glass fiber content

EW/WV – Elbow compression connectors



| EW/WV – ELBOW COMPRESSION CONNECTORS | | | | | | |
|--------------------------------------|--------------------|----------------|----------------|------------------|------------------|--------------------------------|
| Nominal size ID PA tube (in mm) | Designation | D ₁ | D ₂ | L ₁ ~ | L ₂ ~ | Material PA6-GF30* Product No. |
| 6 | EW 6 x 1 - R 1/8 | 6 x 1 | R 1/8 con. | 19 | 23 | 0780 8905 001 |
| | EW 6 x 1 - R 1/4 | 6 x 1 | R 1/4 con. | 23 | 23 | 0780 8905 002 |
| | EW 6 x 1 - M10 x 1 | 6 x 1 | M10 x 1 con. | 19 | 23 | 0780 8905 003 |
| 8 | EW 8 x 1 - R 1/8 | 8 x 1 | R 1/8 con. | 19 | 23 | 0780 8905 021 |
| | EW 8 x 1 - R 1/4 | 8 x 1 | R 1/4 con. | 23 | 23 | 0780 8905 022 |
| | EW 8 x 1 - M10 x 1 | 8 x 1 | M10 x 1 con. | 19 | 23 | 0780 8905 023 |
| | WV 8 x 1 | 8 x 1 | 8 x 1 | 23 | 23 | 0781 8900 011 |

* Glass fiber content

VT/VTR – Equal T and reducing T compression connectors



| VT/VTR – EQUAL T AND REDUCING T COMPRESSION CONNECTORS | | | | | | |
|--|-----------------------|----------------|----------------|------------------|------------------|--------------------------------|
| Nominal size ID PA tube (in mm) | Designation | D ₁ | D ₂ | L ₁ ~ | L ₂ ~ | Material PA6-GF30* Product No. |
| 6 and/or 8 | VT 6 x 1 | 6 x 1 | 6 x 1 | 23 | 23 | 0781 8900 001 |
| | VT 8 x 1 | 8 x 1 | 8 x 1 | 23 | 23 | 0781 8900 002 |
| | VTR 6 x 1-8 x 1-6 x 1 | 6 x 1 | 8 x 1 | 23 | 23 | 0781 8900 021 |
| | VTR 8 x 1-6 x 1-8 x 1 | 8 x 1 | 6 x 1 | 23 | 23 | 0781 8900 022 |

* Glass fiber content

VG/VGR – Straight/Reducing compression connectors



| VG/VGR – STRAIGHT/REDUCING COMPRESSION CONNECTORS | | | | | |
|---|-------------------|----------------|------------------|----|--------------------------------|
| Nominal size ID PA tube (in mm) | Designation | D ₁ | L ₁ ~ | SW | Material PA6-GF30* Product No. |
| 6 and/or 8 | VG 6 x 1 | 6 x 1 | 31 | 17 | 0781 8901 003 |
| | VG 8 x 1 | 8 x 1 | 31 | 17 | 0781 8901 002 |
| | VGR 8 x 1 - 6 x 1 | 6 x 1 | 31 | 17 | 0781 8901 004 |

* Glass fiber content

NORMAQUICK® – Quick Connectors

Innovative, secure and quick fit plug-in connectors

NORMA Group's quick connector range offers state-of-the-art connections. They are made from synthetic material and can be used for most media-carrying lines. Excellent temperature and chemical resistance is combined with a lightweight and compact design to reduce assembly times.



Robust elements for fluid transport – NORMAQUICK®



NORMA Group offers a wide selection of high-quality, robust quick connectors for use in fuel systems, oil systems and other lines that transport media. Their compact, lightweight design helps to cut costs and save weight in any application. They are also suitable for installation in very tight spaces. Our Quick Connectors are used in many industrial applications, e.g. on lubrication lines in industrial machinery.

Product benefits at a glance

- ✓ Leakproof connections
- ✓ Fast assembly
- ✓ Sturdy, compact design

Range and applications

NORMAQUICK® S Quick Connectors are attached to their counterparts (spigots) to connect a fluid system with a technical component. They transport air, fuel, oil, cooling water, battery fluid and other fluids. Each has a locking mechanism at the head made of metal or plastic to ensure safe fluid transport.



S
Highest safety performance according to SAE standard for use in the field of fuel.

NORMAQUICK® SR Single-Lock connectors have a chamfer design-based locking mechanism for reliable connection of fuel lines. Here the safety requirements are especially rigorous: fuel must never leak from the tank or engine of a vehicle. The chamfer feature in the connector locks the retainer under pressure ensuring 100% reliable connection.



SR Single-Lock
Simple and safe with single-lock mechanism for use in fuel and urea.

NORMAQUICK® PS3 “Push & Seal” plastic quick connectors are an ideal means for the secure connection of coolant and heater hoses as well as charged air systems.



PS3
“Push & Seal” connection for cooling water/heating pipes and charged air.

NORMAQUICK® V2 quick connectors are an ideal means to connect media carrying lines as well as ventilation and exhaust lines. The connectors can be used for both line-to-line and line-to-device connections. Our V2 can be applied on both plastic and metal spigots.



V2
Secure connection of media carrying lines, ventilation and exhaust lines.

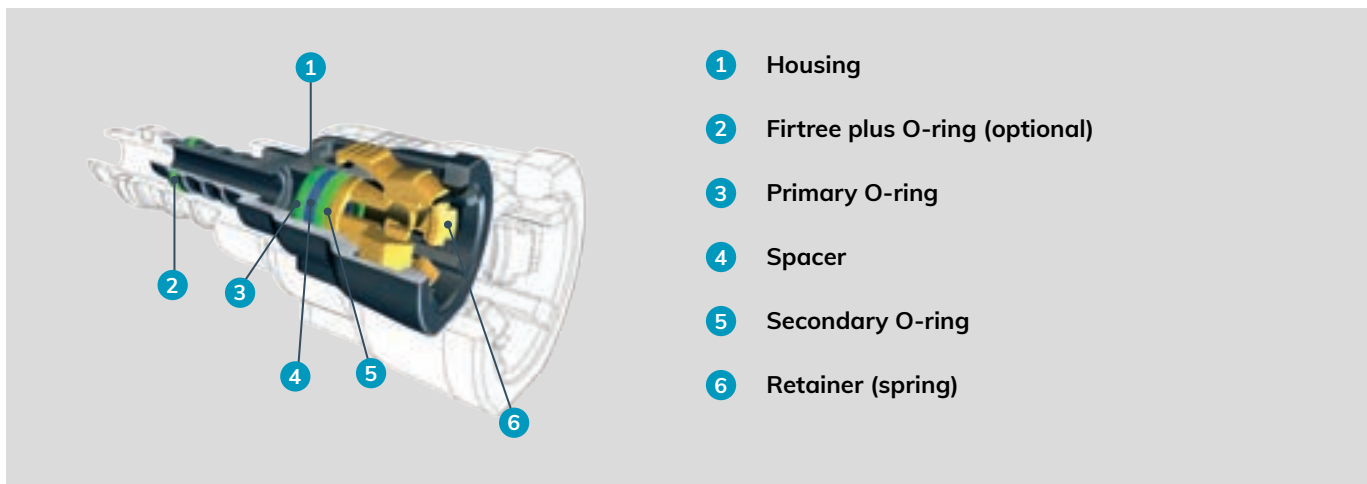

- 1 Housing
- 2 Firtree plus O-ring (optional)
- 3 Primary O-ring
- 4 Spacer
- 5 Secondary O-ring
- 6 Retainer (spring)

Efficient connection of fuel carrying lines

NORMAQUICK® S plastic quick connectors designed according to SAE standard are the ideal means for connecting media carrying lines in combustion engines. It has been especially developed for fuel system applications and is characterized by its “click” sound as well as its quick and safe connection.

Advantages at a glance

- ✓ Leak-proof connection due to sealing with two O-rings
- ✓ Cannot be opened under pressure due to two locking arms
- ✓ Offers audible indicator to ensure locking
- ✓ Compact design allows for assembly in narrow spaces
- ✓ No assembly tool required

Materials

| | |
|----------|--|
| Housing | PA12-GF50 |
| Retainer | PA12-GF30 |
| O-rings | Inside housing FPM & FVMQ; on fir tree FPM |

Technical drawing

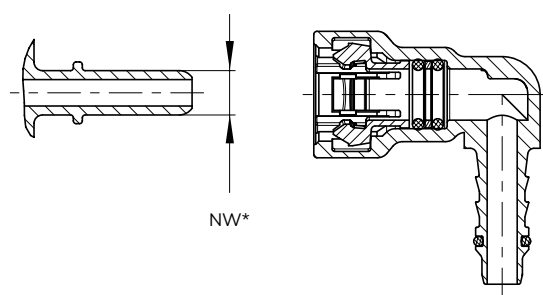

* NW (Nominal Width): Diameter of the connecting spigot

Applications

NORMAQUICK® S connectors are ideal means for connecting fuel lines. They are designed to connect worldwide standardized spigots as per SAEJ2044 guidelines.

Technical data & Ordering information

| NORMAQUICK® S | | |
|---------------------------------------|------------------------------|---------------|
| Designation | Ø Nominal width (mm or inch) | Product No. |
| NORMAQUICK® S NW 1/4" - 1/4" - 0° | 1/4" | 0715 6002 006 |
| NORMAQUICK® S NW 1/4" - 1/4" - 90° | 1/4" | 0715 6001 006 |
| NORMAQUICK® S NW 5/16" - 5/16" - 0° | 5/16" | 0715 6103 008 |
| NORMAQUICK® S NW 5/16" - 5/16" - 90° | 5/16" | 0715 6555 008 |
| NORMAQUICK® S NW 5/16" - 6 mm - 0° | 5/16" | 0715 6509 008 |
| NORMAQUICK® S NW 5/16" - 6 mm - 90° | 5/16" | 0715 6511 008 |
| NORMAQUICK® S NW 8 mm - 6 mm - 0° | 8 mm | 0715 6501 008 |
| NORMAQUICK® S NW 8 mm - 6 mm - 90° | 8 mm | 0715 6502 008 |
| NORMAQUICK® S NW 3/8" - 6 mm - 0° | 3/8" | 0715 6550 010 |
| NORMAQUICK® S NW 3/8" - 6 mm - 90° | 3/8" | 0715 6510 010 |
| NORMAQUICK® S NW 3/8" - 5/16" - 0° | 3/8" | 0715 6509 010 |
| NORMAQUICK® S NW 3/8" - 5/16" - 90° | 3/8" | 0715 6519 010 |
| NORMAQUICK® S NW 9.89 mm - 8 mm - 0° | 9.89 mm | 0715 6701 010 |
| NORMAQUICK® S NW 9.89 mm - 8 mm - 90° | 9.89 mm | 0715 6702 010 |
| NORMAQUICK® S NW 1/2" - 10 mm - 0° | 1/2" | 0715 6595 012 |
| NORMAQUICK® S NW 1/2" - 10 mm - 90° | 1/2" | 0715 6596 012 |
| NORMAQUICK® S NW 1/2" - 12 mm - 0° | 1/2" | 0715 6506 012 |
| NORMAQUICK® S NW 1/2" - 12 mm - 90° | 1/2" | 0715 6507 012 |
| NORMAQUICK® S NW 5/8" - 5/8" - 0° | 5/8" | 0715 6501 016 |
| NORMAQUICK® S NW 5/8" - 5/8" - 90° | 5/8" | 0715 6502 016 |

NORMAQUICK®



- 1 Chamfer
- 2 O-ring
- 3 Housing

Connection of media-carrying lines in vehicles

NORMAQUICK® SR Single-Lock quick connectors are used mainly in the automotive fluid line applications. Designed according to SAE standard, they are known for their high quality and ease of assembly and disassembly process.

Advantages at a glance

- ✓ Chamfer feature locks the retainer under pressure, making the connection highly reliable
- ✓ Audible indicator (“click”) confirms locking of the adapter
- ✓ Compact design allows for assembly in narrow spaces
- ✓ Zero leakage
- ✓ No assembly tool required

Applications

NORMAQUICK® SR Single-Lock connectors are an ideal means of connecting fuel lines. They are designed to meet SAE J2044 standards. Ø 13 mm is used for crankcase ventilation systems.

Technical data & Ordering information

| NORMAQUICK® SR Single-Lock | | |
|---|--------------------|---------------|
| Designation | Nominal width (mm) | Product No. |
| SR Single-Lock - Ø 7.89 mm - tube ID 6.00 mm - 0° | 7.89 | A614A50-06M04 |
| SR Single-Lock - Ø 7.89 mm - tube ID 6.00 mm - 90° | 7.89 | A624E50-06M04 |
| SR Single-Lock - Ø 8.00 mm - tube ID 6.00 mm - 0° | 8.00 | A610R08-06M02 |
| SR Single-Lock - Ø 8.00 mm - tube ID 6.00 mm - 90° | 8.00 | A620N08-06M02 |
| SR Single-Lock - Ø 9.49 mm - tube ID 8.00 mm - 0° | 9.49 | A613A53-08M02 |
| SR Single-Lock - Ø 9.49 mm - tube ID 8.00 mm - 90° | 9.49 | A623C53-08M04 |
| SR Single-Lock - Ø 9.89 mm - tube ID 8.00 mm - 0° | 9.89 | A614-52-08M01 |
| SR Single-Lock - Ø 9.89 mm - tube ID 8.00 mm - 90° | 9.89 | A624-52-08M01 |
| SR Single-Lock - Ø 10.00 mm - tube ID 8.00 mm - 0° | 10.00 | A610M10-08M02 |
| SR Single-Lock - Ø 10.00 mm - tube ID 8.00 mm - 90° | 10.00 | A620N10-08M02 |
| SR Single-Lock - Ø 13.00 mm - tube ID 8.00 mm - 0° | 13.00 | 9615 13 10M05 |
| SR Single-Lock - Ø 13.00 mm - tube ID 8.00 mm - 90° | 13.00 | 9625 13 10M05 |

Materials

| | |
|----------|--|
| Housing | PA12-GF30 (Ø 7.89 mm to 10.00 mm) and PA66-GF30 (Ø 13.00 mm) |
| Retainer | PA12-GF30 |

Technical drawing

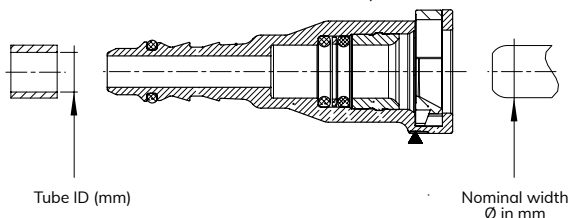

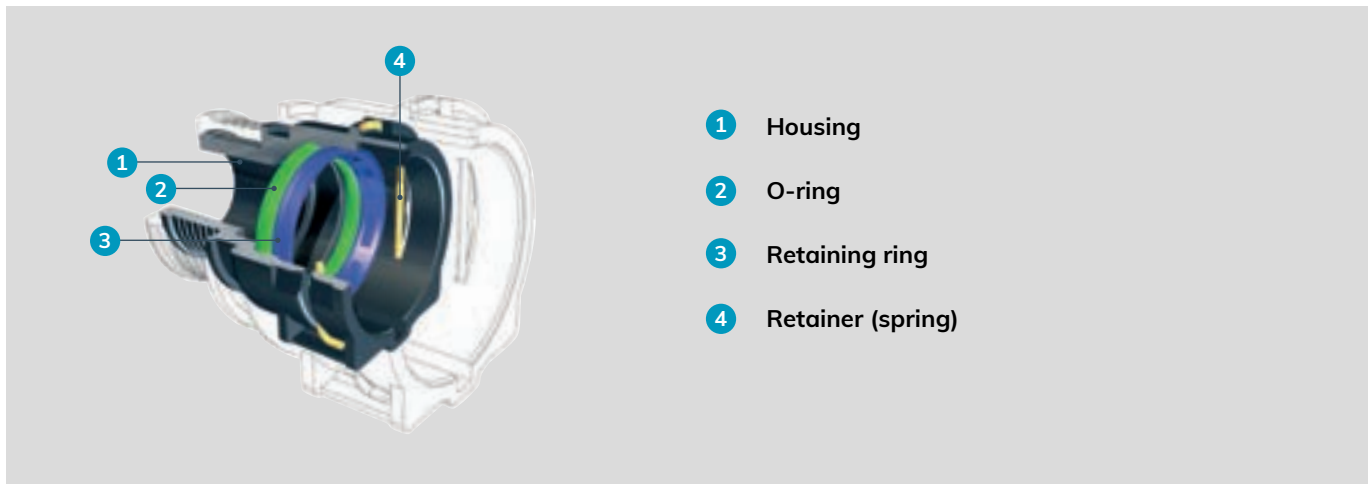

Secure connection for cooling water and heating hoses

NORMAQUICK® PS3 “Push & Seal” plastic quick connectors are an ideal means for the secure connection of cooling water and heating hoses.

Advantages at a glance

- ✓ Time and cost reduction due to snap assembly without tool
- ✓ Application in extremely narrow spaces thanks to compact dimensions
- ✓ Optimal tightness through integrated seal
- ✓ Designed to be mounted on standard spigot design
- ✓ Resistance to coolant medium thanks to O-ring consisting of peroxide cured EPDM
- ✓ PA66 (GF30 housing and retainer) stabilized against heat and hydrolysis effect for direct contact with coolant
- ✓ Made from recyclable materials

Technical data & Ordering information

| NORMAQUICK® PS3 | | |
|-----------------------------|--------------------|---------------|
| Designation | Nominal width (mm) | Product No. |
| NORMAQUICK® PS3 NW 06-0° | 6.00 | 0702 8003 006 |
| NORMAQUICK® PS3 NW 06-6-90° | 6.00 | 0702 8008 006 |
| NORMAQUICK® PS3 NW 08-0° | 8.00 | 0702 7002 008 |
| NORMAQUICK® PS3 NW 08-90° | 8.00 | 0702 7703 008 |
| NORMAQUICK® PS3 NW 12-0° | 12.00 | 0702 6009 012 |
| NORMAQUICK® PS3 NW 12-90° | 12.00 | 0702 6008 012 |
| NORMAQUICK® PS3 NW 16-0° | 16.00 | 0702 7019 016 |
| NORMAQUICK® PS3 NW 16-90° | 16.00 | 0702 6020 016 |
| NORMAQUICK® PS3 NW 20-0° | 20.00 | 0702 7003 020 |
| NORMAQUICK® PS3 NW 20-90° | 20.00 | 0702 7004 020 |
| NORMAQUICK® PS3 NW 26-0° | 26.00 | 0702 6007 026 |
| NORMAQUICK® PS3 NW 26-90 | 26.00 | 0702 7011 026 |
| NORMAQUICK® PS3 NW 32-0° | 32.00 | 0702 7018 032 |
| NORMAQUICK® PS3 NW 32-90° | 32.00 | 0702 7042 032 |

Materials

| | |
|-------------------|---|
| Housing | PA66-GF30 |
| O-ring | EPDM (peroxide cured) |
| Fastening ring | PA66-GF30 |
| Retainer (spring) | Stainless steel 1.4310 (DIN EN 10270-3) |

Applications

NORMAQUICK® PS3 connectors are used for leak proof connection of cooling water lines or heating lines in passenger and commercial vehicles.

Technical drawing

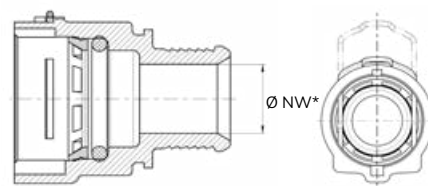

* Ø NW: Nominal Width



Quick assembly and compact design

NORMAQUICK® Single-Lock quick connectors are used mainly in the automotive fluid line applications. Designed according to SAE standard, they are known for their high quality and ease of assembly and disassembly process.

Advantages at a glance

- ✓ Quick assembly time equaling cost reduction
- ✓ Automated production, no human factor means less margin of error
- ✓ No tools needed
- ✓ Compact dimensions allowing ease of use in narrow spaces
- ✓ An integrated seal provides optimal tightness
- ✓ All seals can be visually checked, permitting safe assembly

Technical data & Ordering information

| NORMAQUICK® V2 | | | | | |
|-----------------|-----------|--------------------------|----------------|------------------|---------------|
| Designation | Ø NW (mm) | Recommended applications | Primary O-ring | Secondary O-ring | Product No. |
| V2 NW 06-90° | 6 | VAC, AFS, SAS | FPM | HNBR | 0713 7006 006 |
| V2 NW 08-0° | 8 | VAC, AFS, SAS | FPM | FVMQ | 0713 6029 008 |
| V2 NW 08-90° | 8 | VAC, AFS, SAS | FPM | FVMQ | 0713 6012 008 |
| V2 NW 08-90° | 8 | VAC, AFS, SAS | FPM | HNBR | 0713 7010 008 |
| V2 NW 10-06-90° | 10 | VAC, AFS, SAS | FPM | - | 0713 7095 010 |
| V2 NW 10-10-90° | 10 | VAC, AFS, SAS | FPM | - | 0713 7012 010 |
| V2 NW 10-08-90° | 10 | VAC, AFS, SAS | FPM | - | 0713 7034 010 |
| V2 NW 10-10-0° | 10 | VAC, AFS, SAS | FPM | - | 0713 6033 010 |
| V2 NW 12-12-0° | 12 | CVS, OTS, AFS, SAS | FPM | - | 0713 7030 012 |
| V2 NW 12-12-0° | 12 | CVS, OTS, TVS, AFS, SAS | FPM | HNBR | 0713 6038 012 |
| V2 NW 15-15-0° | 15 | CVS, OTS, AFS, SAS | FPM | - | 0713 6015 015 |
| V2 NW 19-19-0° | 19 | CVS, OTS, AFS, SAS | FPM | - | 0713 6005 019 |
| V2 NW 19-19-90° | 19 | CVS, OTS, TVS, AFS, SAS | FPM | HNBR | 0713 6005 019 |
| V2 NW 27-27-0° | 27 | CVS, OTS, AFS, SAS | FPM | - | 0713 4002 027 |
| V2 NW 27-27-90° | 27 | CVS, OTS, AFS, SAS | FPM | - | 0713 6169 027 |

NORMAQUICK®

Materials

| | |
|---------|---------------------------------------|
| Housing | Polyamide with reinforced glass fibre |
| O-ring | FPM / FVMQ / HNBR |

Applications

- Air intake and induction
- Fuel and oil systems

Technical drawing

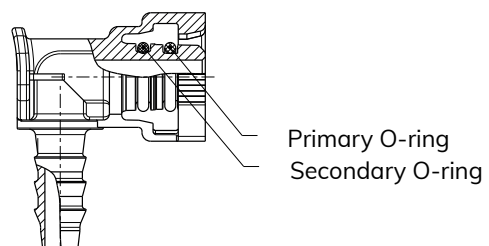

NORMAEXTRA® – Kits, Assortments, Displays, Tools and Accessories

A wide range of assortments, displays, dispensers and tools

NORMA assortments section offers the possibility of having several clamp diameters in one package. All the accessories and the tools mentioned in this chapter are proposed to enable simple and easy installation of the NORMA products.



NORMAEXTRA

KITS

NORMACLAMP® Quick Lock Band-on-roll



| NORMACLAMP® QUICK LOCK BAND-ON-ROLL | | | | | |
|-------------------------------------|-----------------|-------------|--------------------|----------------|----------------|
| Width in mm | Designation | Length in m | Number of closures | W2 Product No. | W4 Product No. |
| 9 | BAND-ON-ROLL 3M | 3 | 8 | 0815 7121 001 | 0815 7131 001 |
| | BAND-ON-ROLL 5M | 5 | 8 | 0815 7121 003 | 0815 7131 003 |
| 12 | BAND-ON-ROLL 3M | 3 | 6 | 0815 6007 002 | |
| | BAND-ON-ROLL 5M | 5 | 6 | 0815 6007 004 | |

NORMA® FUEL LINE REPAIR KIT



| NORMA® FUEL LINE REPAIR KIT | | |
|---------------------------------------|----------|---------------|
| Content | Quantity | Product No. |
| NORMAQUICK S NW 3/8"-5/16"-0° Adapter | 2 | 0715 2000 003 |
| NORMAQUICK S NW 5/16"-6 mm-0° Adapter | 2 | |
| NORMAQUICK S NW 5/16"-6 mm-0° | 2 | |
| NORMAQUICK S NW 5/16"-6 mm-90° | 2 | |
| NORMAQUICK S NW 9.89 mm-8 mm-0° | 1 | |
| NORMAQUICK S NW 9.89 mm-8 mm-90° | 1 | |
| NORMAQUICK S NW 3/8"-5/16"-0° | 2 | |
| NORMAQUICK S NW 3/8"-5/16"-90° | 2 | |
| Sleeve - Ø 6 mm | 4 | |
| Sleeve - Ø 8 mm | 4 | |
| Rubber hose - ID 8 mm | 2 | |
| Rubber hose - ID 10 mm | 2 | |
| ABA MINI 14/9 W4 | 8 | |
| ABA MINI 16/9 W4 | 8 | |

NORMACLAMP® TORRO® Assortment type 120 pcs



| NORMACLAMP® TORRO® ASSORTMENT TYPE 120 PCS | | | | | |
|--|-----------------|----------------------|----------|----------------|----------------|
| Width in mm | Designation | Clamping range in mm | Quantity | W1 Product No. | W4 Product No. |
| 9 | TORRO 8 - 16/9 | 8 - 16 | 40 | 0126 5005 012 | 0126 5005 014 |
| | TORRO 12 - 22/9 | 12 - 22 | 25 | | |
| | TORRO 16 - 27/9 | 16 - 27 | 20 | | |
| | TORRO 20 - 32/9 | 20 - 32 | 15 | | |
| | TORRO 25 - 40/9 | 25 - 40 | 10 | | |
| | TORRO 35 - 50/9 | 35 - 50 | 10 | | |
| NA | FLEXIDRIVER | NA | 1 | | |

TORRO® WF Assortment



| TORRO® WF ASSORTMENT | | | | |
|----------------------|----------------------|----------------------|----------|----------------|
| Width in mm | Designation | Clamping range in mm | Quantity | W3 Product No. |
| 9 | TORRO® WF 12 - 22/9 | 12 - 22 | 5 | 0137 9702 050 |
| | TORRO® WF 20 - 32/9 | 20 - 32 | 10 | |
| | TORRO® WF 30 - 45/9 | 30 - 45 | 10 | |
| 12 | TORRO® WF 40 - 60/12 | 40 - 60 | 10 | |
| | TORRO® WF 50 - 70/12 | 50 - 70 | 10 | |
| | TORRO® WF 60 - 80/12 | 60 - 80 | 5 | |

NORMACLAMP® COBRA Kit type 500 pcs



This workshop range is a clearly arranged collection of the most commonly used types of NORMACLAMP® COBRA hose clips in a practical plastic case (approx. 34 x 23 x 5 cm).

A workshop range comprises of 500 NORMACLAMP® COBRA hose clips made from stainless steel nickel chromium steel and with band widths of 7 mm and 8 mm as follows:

| NORMACLAMP® COBRA KIT TYPE 500 pcs | | | | |
|------------------------------------|--------------|----------------|----------|----------------|
| Width in mm | Designation | Diameter in mm | Quantity | W4 Product No. |
| 7 | COBRA 7.5/7 | 7.5 | 30 | 0773 9000 500 |
| | COBRA 8/7 | 8 | 25 | |
| | COBRA 8.5/7 | 8.5 | 25 | |
| | COBRA 9/7 | 9 | 25 | |
| | COBRA 9.5/7 | 9.5 | 25 | |
| | COBRA 10/7 | 10 | 25 | |
| | COBRA 10.5/7 | 10.5 | 25 | |
| | COBRA 11/7 | 11 | 25 | |
| | COBRA 11.5/7 | 11.5 | 25 | |
| 8 | COBRA 12/8 | 12 | 30 | |
| | COBRA 13/8 | 13 | 30 | |
| | COBRA 14/8 | 14 | 30 | |
| | COBRA 15/8 | 15 | 30 | |
| | COBRA 16/8 | 16 | 30 | |
| | COBRA 17/8 | 17 | 30 | |
| | COBRA 18/8 | 18 | 30 | |
| | COBRA 19/8 | 19 | 30 | |
| | COBRA 21/8 | 21 | 30 | |

NORMAEXTRA

ASSORTMENTS

NORMACLAMP® FBS Assortment



| NORMACLAMP® FBS ASSORTMENT | | |
|----------------------------|----------|------------------|
| Designation | Quantity | PA 6 Product No. |
| FBS 14/12 SW | 10 | 0112 7024 001 |
| FBS 16/12 SW | 10 | |
| FBS 17/12 SW | 10 | |
| FBS 19/12 SW | 10 | |
| FBS 23/12 SW | 10 | |
| FBS 27/12 SW | 5 | |
| FBS 29/12 SW | 5 | |
| FBS 32/12 SW | 5 | |
| FBS 40/12 SW | 5 | |
| FBS 44/12 SW | 5 | |

NORMAQUICK® PLAST® Assortment



| NORMAquick® PLAST® ASSORTMENT | | |
|-------------------------------|----------|------------------|
| Designation | Quantity | PA 6 Product No. |
| NQS NW 8-6 0° | 3 | 0700 2011 000 |
| NQS NW8-6 90° | 3 | |
| NQS NW10-8-0° | 3 | |
| NQS NW10-8-90° | 3 | |
| NQS NW1/4"-1/4"-0° | 3 | |
| NQS NW1/4"-1/4"-90° | 3 | |
| NQS NW5/16"-06-0° | 3 | |
| NQS NW5/16"-06-90° | 3 | |
| ADAPTER NQS 5/16"-6-0° | 3 | |
| NQS NW3/8"-5/16-0° | 3 | |
| NQS NW3/8"-5/16-90° | 3 | |
| ADAPTER NQSNW3/8"-5/16"-0° | 3 | |
| GS 6 | 5 | |
| TS 6 | 5 | |
| GS 8 | 5 | |
| TS 8 | 5 | |
| GS 10 | 5 | |
| TS 10 | 5 | |

NORMAPLAST® Assortment type 365 PA 6 and TORRO® W2



| NORMAPLAST® ASSORTMENT TYPE 365 PA 6 and TORRO® W2 | | | | |
|--|-------------------|----------------|----------|------------------------------|
| Width in mm | Designation | Diameter in mm | Quantity | PA 6 W2 (TORRO®) Product No. |
| NA | GS 4 | 4 | 50 | 0773 9000 365 |
| | TS 4 | 4 | 50 | |
| | YS 4 | 4 | 50 | |
| | GS 6 | 6 | 25 | |
| | TS 6 | 6 | 25 | |
| | YS 6 | 6 | 25 | |
| | GS 8 | 8 | 20 | |
| | TS 8 | 8 | 10 | |
| | YS 8 | 8 | 10 | |
| | GRS 8 - 6 | 8 | 20 | |
| 7.5 | TORRO 8 - 12/7.5 | 8 - 12 | 40 | |
| | TORRO 10 - 16/7.5 | 10 - 16 | 40 | |

NORMACLAMP® TORRO® Dispenser



| NORMACLAMP® TORRO® DISPENSER | | | | |
|------------------------------|------------------|----------------------|----------|----------------|
| Width in mm | Designation | Clamping range in mm | Quantity | W2 Product No. |
| 7.5 | TORRO 8 - 12/7.5 | 8 - 12 | 10 | 0126 9702 010 |
| 9 | TORRO 8 - 16/9 | 8 - 16 | 10 | |
| | TORRO 12 - 22/9 | 12 - 22 | 10 | |
| | TORRO 16 - 27/9 | 16 - 27 | 10 | |
| | TORRO 20 - 32/9 | 20 - 32 | 10 | |
| | TORRO 25 - 40/9 | 25 - 40 | 10 | |
| | TORRO 32 - 50/9 | 32 - 50 | 10 | |
| | TORRO 40 - 60/9 | 40 - 60 | 10 | |
| | TORRO 50 - 70/9 | 50 - 70 | 10 | |
| TORRO 60 - 80/9 | 60 - 80 | 10 | | |

NORMACLAMP® TORRO® Pallet



| NORMACLAMP® TORRO® PALLET | | | | | |
|---------------------------|-----------------|----------------------|----------|----------------|----------------|
| Width in mm | Designation | Clamping range in mm | Quantity | W1 Product No. | W4 Product No. |
| 9 | TORRO 8 - 16/9 | 8 - 16 | 40 | 0126 5006 012 | 0126 5006 015 |
| | TORRO 12 - 22/9 | 12 - 22 | 25 | | |
| | TORRO 16 - 27/9 | 16 - 27 | 20 | | |
| | TORRO 20 - 32/9 | 20 - 32 | 15 | | |
| | TORRO 25 - 40/9 | 25 - 40 | 10 | | |
| | TORRO 35 - 50/9 | 35 - 50 | 10 | | |
| NA | FLEXIDRIVER | NA | 1 | | |

NORMACLAMP® Quick Lock Band-on-roll dispenser



| NORMACLAMP® QUICK LOCK BAND-ON-ROLL DISPENSER | | | | |
|---|-----------------|-------------|----------------|----------------|
| Width in mm | Designation | Length in m | W2 Product No. | W4 Product No. |
| 9 | BAND-ON-ROLL 3M | 3 | 0815 5007 015 | 0815 5007 014 |
| | BAND-ON-ROLL 5M | 5 | 0815 5007 017 | 0815 5007 016 |

NORMAEXTRA

NORMACLAMP® TORRO® Assembly fixture



| NORMACLAMP® TORRO® ASSEMBLY FIXTURE | |
|-------------------------------------|---------------|
| Designation | Product No. |
| TORRO ASSEMBLY FIXTURE | 0126 9900 001 |

NORMACLAMP® COBRA Pneumatic pliers



These pneumatically assisted pliers are the ideal installation tool for industrial applications, allowing serial installation work involving large quantities to be handled with ease.

| NORMACLAMP® COBRA PNEUMATIC PLIERS | |
|------------------------------------|---------------|
| Designation | Product No. |
| COBRA PNEUMATIC PLIERS | 0110 8420 010 |

NORMACLAMP® FBS Pneumatic pliers

1



1 Version S

Suitable for “vertical” assembly operations where the clamp head is approached from above. Ideal for high volume series assembly.

2 Version W

Suitable for “horizontal” assembly operations where the clamp head is approached from the side. For high volume series assembly.

2



| NORMACLAMP® FBS PNEUMATIC PLIERS TYPE S | |
|---|-----------------|
| Designation | Product No. |
| FBS PNEUMATIC PLIERS TYPE S | 0115 0000 911*1 |
| FBS PNEUMATIC PLIERS TYPE S | 0115 0000 912*2 |

| NORMACLAMP® FBS PNEUMATIC PLIERS TYPE W | |
|---|-----------------|
| Designation | Product No. |
| FBS PNEUMATIC PLIERS TYPE W | 0115 0000 919*1 |
| FBS PNEUMATIC PLIERS TYPE W | 0115 0000 920*2 |

*1 jaws are opened before release
*2 jaws are closed before release

NORMACLAMP® FBS C Multi-release tool



For unlocking pre-opened FBS C, only our release tool is permitted.

| NORMACLAMP® FBS C MULTI-RELEASE TOOL | |
|--------------------------------------|---------------|
| Designation | Product No. |
| FBS C MULTI-RELEASE TOOL | 0115 0000 936 |

NORMAFIX® Cable tie pliers



2.2 to 4.8 mm



4.8 to 7.8 mm



3.6 mm to 13 mm



4.7 mm to 13 mm



3.6 mm to 13 mm



4.7 mm to 13 mm

| | |
|--|--|
| 1 | NORMAFIX® CABLE TIE PLIERS FROM 2.2 TO 4.8 MM |
| Designation | Product No. |
| PLIERS FOR NYLON CABLE TIE FROM 2.2 TO 4.8 MM - SEMI-AUTOMATIC | 0860 1000 001 |
| 2 | NORMAFIX® CABLE TIE PLIERS FROM 4.8 TO 7.8 MM |
| Designation | Product No. |
| PLIERS FOR NYLON CABLE TIE FROM 4.8 TO 7.8 MM - SEMI-AUTOMATIC | 0860 1000 004 |
| 3 | NORMAFIX® CABLE TIE PLIERS FROM 3.6 TO 13 MM |
| Designation | Product No. |
| PLIERS FOR NYLON CABLE TIE F ROM 3.6 TO 13 MM - MANUAL | 0860 1000 005 |
| 4 | NORMAFIX® CABLE TIE PLIERS FROM 4.7 TO 13 MM |
| Designation | Product No. |
| PLIERS FOR NYLON CABLE TIE FROM 4.7 TO 13 MM - MANUAL | 0892 0000 003 |
| 5 | NORMAFIX® PLIERS FOR STAINLESS STEEL BALL LOCKING CABLE TIES FROM 3.8 TO 9 MM |
| Designation | Product No. |
| PLIERS FOR STAINLESS STEEL BALL LOCKING CABLE TIES FROM 3.8 TO 9 MM - SEMI-AUTOMATIC | 0892 0000 001 |
| 6 | NORMAFIX® PLIERS FOR STAINLESS STEEL BALL LOCKING CABLE TIES FROM 3.8 TO 9 MM |
| Designation | Product No. |
| PLIERS FOR STAINLESS STEEL BALL LOCKING CABLE TIES FROM 3.8 TO 9 MM - MANUAL | 0892 0000 002 |

NORMAFIX® NORMETTA® Clamping and cutting tool



This high quality cast tool is recommended for professional work. Easy to use, it provides a tensile force of approximately 10,000 N (1000 KP).

| | |
|--|---------------|
| NORMAFIX® NORMETTA® CLAMPING AND CUTTING TOOL | |
| Designation | Product No. |
| CLAMPING AND CUTTING TOOL | 0560 8555 001 |

NORMACLAMP® Ear clip pliers



| NORMACLAMP® EARCLIP PLIERS | |
|------------------------------|---------------|
| Designation | Product No. |
| EAR CLIP PLIERS END CLOSING | 0819 0022 094 |
| EAR CLIP PLIERS SIDE CLOSING | 0819 0022 095 |

NORMACLAMP® COBRA Handheld pliers



CHT1



CHT2

These handheld pliers enable precise installation and removal. The tips of the pliers' head enable a secure grip on the clip's tool gripping points. The integrated smooth-running spring element keeps the pliers open continuously, allowing you to work quickly and comfortably.

CHT 1 allows a connect and disconnect function.
CHT 2 only allows a connection function.

| NORMACLAMP® COBRA CHT 1 | |
|-------------------------|---------------|
| Designation | Product No. |
| COBRA CHT 1 | 0110 8420 000 |

| NORMACLAMP® COBRA CHT 2 | |
|-------------------------|---------------|
| Designation | Product No. |
| COBRA CHT 2 | 0110 8420 004 |

PLIERS

NORMACLAMP® FBS Handheld pliers

1



2



For professional installation of FBS standard clamps, two types of handheld pliers are available depending on the nominal diameter involved:

- 1 Type 1: for small nominal diameters (up to 40 mm).
- 2 Type 2: for all diameters, with integrated safety lever for fixing the pliers in position.

| NORMACLAMP® FBS PLIERS | |
|------------------------|---------------|
| Designation | Product No. |
| FBS PLIERS | 0115 0000 903 |

| NORMACLAMP® FBS PLIERS WITH INTEGRATED SAFETY LEVER | |
|---|---------------|
| Designation | Product No. |
| FBS PLIERS WITH INTEGRATED SAFETY LEVER | 0115 0000 904 |

Pliers for the FBS R are available on request

NORMAFIX® RSGUV 1 / RSV 1 Handheld pliers



For professional installation of RSGUV 1 / RSV 1 clips, two types of handheld pliers are available depending on the band width involved.

| NORMAFIX® RSGUV 1 / RSV 1 PLIERS | |
|----------------------------------|---------------|
| Designation | Product No. |
| RSGUV 1 / RSV 1 PLIERS 15 | 0981 0000 151 |
| RSGUV 1 / RSV 1 PLIERS 20 | 0981 0000 201 |

NORMACLAMP® TORRO® Screwdriver SW6, SW7, SW6/7



| NORMACLAMP® TORRO® SCREWDRIVER SW6, SW7, SW6/7 | |
|--|---------------|
| Designation | Product No. |
| SW6 | 0000 0000 899 |
| SW7 | 0000 0000 898 |
| SW6/7 | 0000 0000 894 |

NORMACLAMP® Tamperproof Screwdriver



| NORMACLAMP® TAMPERPROOF SCREWDRIVER | |
|-------------------------------------|---------------|
| Designation | Product No. |
| TAMPERPROOF SCREWDRIVER | 0126 9900 003 |

NORMACLAMP® Hi-torque T-screwdriver



| NORMACLAMP® HI-TORQUE T-SCREWDRIVER | |
|-------------------------------------|---------------|
| Designation | Product No. |
| T-SCREWDRIVER FOR HI-TORQUE CLAMP | 0560 6600 001 |

NORMAFIX® Tube clamp fittings Hexagonal key



| NORMAFIX® HEXAGONAL KEY | | |
|------------------------------|----------------|---------------|
| Designation | Diameter in mm | Product No. |
| HEXAGONAL KEY 26.9/33.7 | 26.9/33.7 | 0819 6332 001 |
| HEXAGONAL KEY 42.4/48.3/60.3 | 42.4/48.3/60.3 | 0819 6332 002 |

NORMAEXTRA

NORMAFIX® Tube clamp fittings Plastic end cap



| NORMAFIX® PLASTIC END CAP | | |
|---------------------------|----------------|---------------|
| Designation | Diameter in mm | Product No. |
| PLASTIC END CAP 33.7 | 33.7 | 0819 6330 034 |
| PLASTIC END CAP 42.4 | 42.4 | 0819 6330 042 |
| PLASTIC END CAP 48.3 | 48.3 | 0819 6330 048 |

NORMAFIX® Tube clamp fittings Spare screws



| NORMAFIX® SPARE SCREW | | |
|----------------------------|----------------|---------------|
| Designation | Diameter in mm | Product No. |
| SPARE SCREW 26.9/33.7 | 26.9/33.7 | 0819 6331 001 |
| SPARE SCREW 42.4/48.3/60.3 | 42.4/48.3/60.3 | 0819 6331 002 |

NORMAFIX® Lamppost protection tape



| NORMAFIX® LAMPOST PROTECTION TAPE | | |
|--|-------------|-----------------|
| Designation | Length in m | PVC Product No. |
| BLACK EPDM PROTECTION TAPE ROLL OF 10 METERS | 10 | 0560 7640 010 |
| WRAP & SEAL VULCANIZING STRETCHABLE TAPE TAPE - BLACK 2.4 METERS | 2.4 | 0560 7640 002 |
| WRAP & SEAL VULCANIZING STRETCHABLE TAPE TAPE - BLACK 4.8 METERS | 4.8 | 0560 7640 004 |

NORMAFIX® Cable tie Wall plug bases for cable tie

For fixing cables and pipes to walls. Very easy installation for cable ties up to 9 mm width.



| NORMAFIX® WALL PLUG BASES FOR CABLE TIES | | | |
|---|---------------|---------------|---------------|
| Designation | PA 6.6 | | |
| | White | Black | Grey |
| | Product No. | Product No. | Product No. |
| WALL PLUG BASES FOR CABLE TIES WITHOUT FINS 8 MM BASE | 0860 0701 002 | 0860 0701 001 | |
| WALL PLUG BASES FOR CABLE TIES WITH FINS 6 MM BASE | 0860 0701 112 | 0860 0701 111 | 0860 0703 111 |
| WALL PLUG BASES FOR CABLE TIES WITH FINS 8 MM BASE | 0860 0701 102 | 0860 0701 101 | 0860 0703 101 |

NORMAFIX® Cable tie Mounting bases for cable tie

For fixing cables and pipes to walls. Very easy installation for cable ties up to 9 mm width.



| NORMAFIX® MOUNTING BASES FOR CABLE TIES WITHOUT ADHESIVE | | | | | | | | | |
|--|--|---------------------------------|-----------------|-------------|-----|---|-----|---------------|---------------|
| Number of entrances | Designation | For cable ties band width in mm | Dimensions (mm) | | | | | PA 6.6 | |
| | | | A | B | C | F | H | White | Black |
| | | | Product No. | Product No. | | | | | |
| 1 | MOUNTING BASES FOR CABLE TIES WITHOUT ADHESIVE 3.6 | 3.6 | 19 | 19 | 4.2 | 4 | 5 | 0860 0811 001 | 0860 0812 001 |
| | MOUNTING BASES FOR CABLE TIES WITHOUT ADHESIVE 4.8 | 4.8 | 27 | 27 | 4.2 | 6 | 7.4 | 0860 0811 002 | 0860 0812 002 |
| 2 | MOUNTING BASES FOR CABLE TIES WITHOUT ADHESIVE 3.6 | 3.6 | 19 | 19 | 4.1 | 4 | 5 | 0860 0911 001 | 0860 0912 001 |
| | MOUNTING BASES FOR CABLE TIES WITHOUT ADHESIVE 4.8 | 4.8 | 27 | 27 | 4.8 | 6 | 6.5 | 0860 0911 002 | 0860 0912 002 |

| NORMAFIX® MOUNTING BASES FOR CABLE TIES WITH ADHESIVE | | | | | | | | | |
|---|---|---------------------------------|-----------------|-------------|-----|---|-----|---------------|---------------|
| Number of entrances | Designation | For cable ties band width in mm | Dimensions (mm) | | | | | PA 6.6 | |
| | | | A | B | C | F | H | White | Black |
| | | | Product No. | Product No. | | | | | |
| 1 | MOUNTING BASES FOR CABLE TIES WITH ADHESIVE 3.6 | 3.6 | 19 | 19 | 4.2 | 4 | 5 | 0860 0831 001 | 0860 0832 001 |
| | MOUNTING BASES FOR CABLE TIES WITH ADHESIVE 4.8 | 4.8 | 27 | 27 | 4.2 | 6 | 7.4 | 0860 0831 002 | 0860 0832 002 |
| 2 | MOUNTING BASES FOR CABLE TIES WITH ADHESIVE 3.6 | 3.6 | 19 | 19 | 4.1 | 4 | 5 | 0860 0931 001 | 0860 0932 001 |
| | MOUNTING BASES FOR CABLE TIES WITH ADHESIVE 4.8 | 4.8 | 27 | 27 | 4.8 | 6 | 6.5 | 0860 0931 002 | 0860 0932 002 |

NORMAEXTRA

NOTES

A series of horizontal dotted lines for writing notes.

A series of horizontal dotted lines for writing.

A CONNECTION THAT LASTS



NORMA® Product Catalogue

Discover our complete portfolio

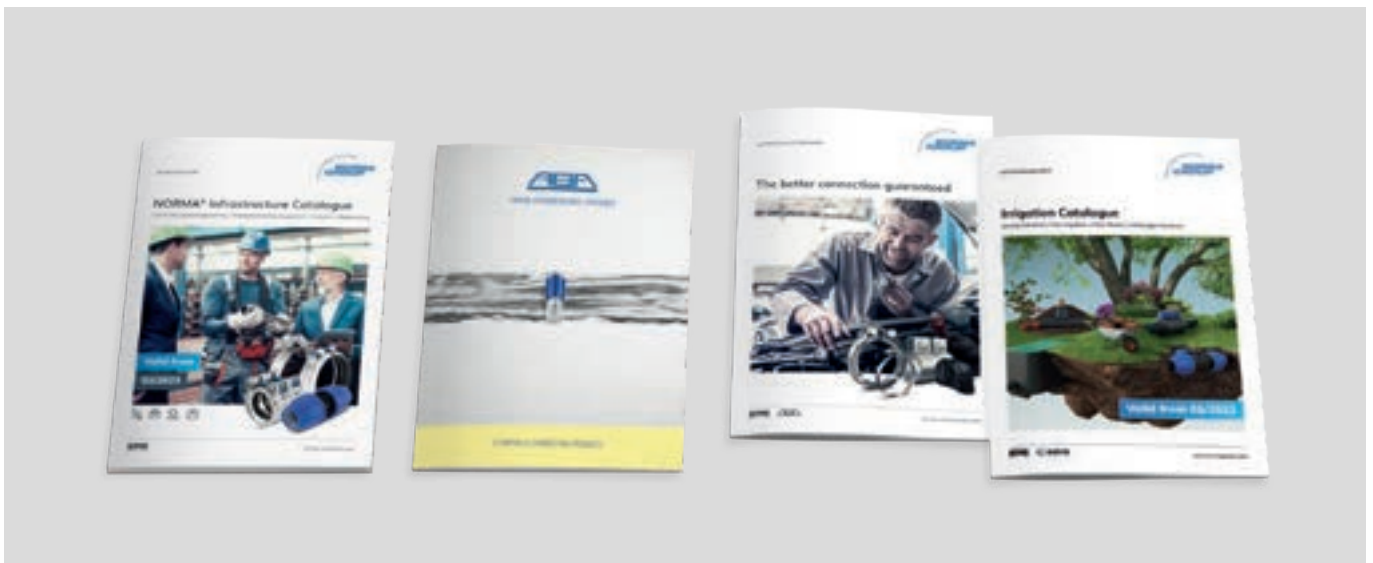

Want to have a look? Simply scan the QR code to download the catalogue.



Infrastructure catalogue

qrco.de/infra-catalogue-en



ABA catalogue

qrco.de/ABA-en



Automotive Aftermarket brochure

qrco.de/AUTO-en



Irrigation catalogue

qrco.de/IR-en



NORMA Group Holding GmbH

Edisonstraße 4
63477 Maintal | Germany

+49 6181-403-0
norma-connects@normagroup.com

Your local distributor:

NORMA Group Holding GmbH | Edisonstraße 4 | 63477 Maintal | Germany | normagroup.com

This document supersedes all previous issues. No part of this publication may be reproduced without our prior written consent. In NORMA Group's policy of continual product improvements to meet user needs and technological developments, all models and sets listed in this folder (photographs, specifications, sizes and weights) may be upgraded or discontinued without notice and without any obligation on our part to modify tools or equipment sold previously. The recommendations for use and safety given in this folder do not replace accepted good practice or the safety related legal and regulatory provisions. References to standards implemented as of February 27, 2023 are not contractually binding.