

NewTom GO COMPLETE.VISION

2D/3D CEPH INTEGRATED IMAGING



Cone Beam 3D Imaging
NewTom
what's next



Making Your Life Better.

BU Medical Equipment

Cefla Medical North America
6125 Harris Technology Blvd.
Charlotte, NC 28269
Ph: 704-598-0020

www.ceflamedicalna.com
info@cefladental.com

Sede legale ed amministrativa Headquarters

Cefla s.c.
Via Selice Provinciale, 23/a
40026 Imola - Bo (Italy)
tel. +39 0542 653111
fax +39 0542 653344

Stabilimento Plant

Via Bicocca, 14/c
40026 Imola - Bo (Italy)
tel. +39 0542 653441
fax +39 0542 653601

newtom.it



Focus PRO

Cone Beam 3D Imaging
NewTom
what's next

05/2024 NG3CPGB231500
According to the standards in force, in extra-EU areas the availability and specifications of some products and/or characteristics may vary. Please contact your local distributor for further information. Pictures are for illustration purpose only.

GO 2D/3D CEPH COMPLETE.VISION

IMAGING EXCELLENCE
COMBINED WITH
THE VERSATILITY
OF A COMPLETE
AND SAFE,
TECHNOLOGICALLY
ADVANCED SYSTEM.

Technological research, reliability and innovation. The functional evolution of the most compact NewTom system, ensuring top performance and the outstanding quality of 2D/3D and CEPH imaging in a versatile and accessible device.

VERSATILE AND PRECISE.

High quality images that meet a wide range of clinical diagnostic needs, all in one compact device.

GO 2D/3D/CEPH is a flexible platform that comes ready for the optional integration of the teleradiographic arm in a 2D or 3D configuration. Able to provide high resolution images, the platform prioritises patient health thanks to low exposure protocols and exclusive SafeBeam™ technology, which lets users adapt the dose to their actual diagnostic needs and the size of the scanned anatomical area.

Excellent ergonomics and an adaptive alignment system ensure correct positioning of the patient and perfect focusing for clear, detailed images. A virtual control panel guides the operator through each stage of the examination. NNT is the technologically advanced software platform to manage, process, consult and share diagnostic images.



BROAD DIAGNOSTIC POTENTIAL

A combination of device versatility and NewTom solutions designed to meet every diagnostic need broaden the opportunities available to the surgery.



ACCESSIBLE TECHNOLOGY

Guided procedures and smart automatic features have made this sophisticated technology available to everyone.



MINIMUM X-RAY DOSE

ECO Dose functions and SafeBeam™ technology, which automatically adapts the X-ray dose to the patient, put patient safety above all else.



MAXIMUM CONNECTIVITY

Acquired X-ray images can easily be stored, exported and shared with specialist third party software.



OUTSTANDING TECHNOLOGY.

Comprehensive NewTom CBCT technology combines with excellent 2D functions to provide reliable diagnostics.

Thanks to CBCT technology - first introduced to the dental industry by NewTom - GO provides extremely useful high definition (80 μm) diagnostics data, obtained with just one scan to minimise X-ray exposure. The field of view is defined according to diagnostic requirements and ranges from a minimum of 6 x 6 cm to a maximum of 10 x 10 cm.

2D images are available with multiple advanced-function protocols that allow dentists to obtain precise data; once again, every precaution is taken to safeguard patient health (e.g. adaptive FOV and quick scans).



HiRes 3D produces images with a voxel size of 80 μm , also available with maximum 10 x 10 cm FOV, critically important for in-depth studies of anatomical details. Other FOVs and other protocols (ECO SCAN and REGULAR QUALITY) allow lower doses to be used according to diagnostic objectives.

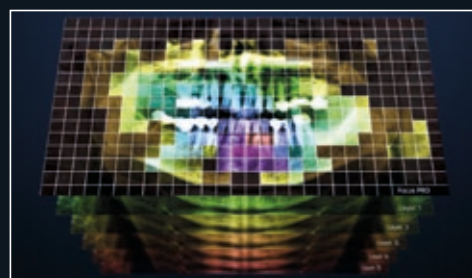

The quality of a panoramic image depends above all on correct focusing of the anatomical structures of interest, obviously in different positions depending on the patient's anatomy. Without any increase in dose, the new **Focus PRO** function automatically adapts the focus to different anatomical profiles and any patient malpositioning. This allows the best possible quality to be obtained in a single scan.



Integration of the teleradiographic arm (which can be done at a later stage) extends the diagnostic capacity of GO 2D/3D to cephalometric examinations. The compact arm, complete with dedicated CEPH sensor, has long and short head support rods to make positioning of adults and children easier. Collimation systems and fast scans minimise X-ray doses.



AUTOMATIC AND ERGONOMIC.

Solutions developed to maximise examination quality, from positioning systems to automated collimation.

To ensure accurate diagnoses in every situation, it is vital to observe procedures that ensure always sharp and clear images. GO 2D/3D has a single native 16-bit sensor that produces 2D and 3D images with thousands of grey levels. Image quality is ensured by advanced algorithms and protocols and by high-tech image sequencing. The high frequency, pulsed-emission generator adjusts exposure to obtain the best scans with a minimum dose.

Moreover, the cephalometric exam collimation system is based on automatic movement of the turret, which rotates and lowers the sensor, creating an opening for the X-rays directed at the 2D sensor on the teleradiographic arm.



With its five contact points, the 3D scan head support helps staff position the patient correctly and comfortably. Frontal and lateral contact points can be adjusted to maximise both patient stability during the scan and, consequently, the quality of the obtained data.

A specific protocol allows for tomographic scans of radiological templates, prostheses, models or impressions after they have been positioned on a special support.



HIGH QUALITY AND PRACTICAL.

Top quality 2D imaging obtained through many advanced functions for more effective diagnostics.

NewTom's established expertise and care for the patient are shared by the NewTom GO system, which today integrates complete cephalometric features.

It supplies detailed images thanks to the sensitivity of the newly developed CMOS sensor. Thanks to its advanced functions, trajectories and collimation designed specifically for each examination, and to special ApT filters that automatically and selectively optimise the display of the different anatomical regions for increasingly sharp details, NewTom GO meets every 2D scanning requirement.

Through the exclusive SafeBeam™ technology, sharp and homogeneous images are automatically obtained, in every anatomical region, auto-adapting exposure parameters to each patient, and minimising X-rays doses.



ORTHOGONAL PANORAMIC FUNCTION

The **adaptive PAN** function provides, in a single scan, 5 optimised images from which users can choose the panoramic view that best suits their diagnostic needs. Captured orthogonally, the dental arch image clearly highlights interproximal spaces and the entire root structure without any overlap.



NEW CEPH HR FUNCTION

The highly compact teleradiographic arm completes the available 2D functions with a wide range of CEPH tests carried out with dedicated protocols for high-resolution imaging. With collimation designed to reduce X-ray doses and quick scan times the focus is on the patient's health.



INTEGRATION OF CEPH ARM.

A complete, all-inclusive system for 2D and CEPH examinations, relocatable sensor, secondary collimator and smart head support unit.

To complete the range of available 2D examination options, the teleradiographic arm allows a full range of cephalometric examinations.

Compact and available with relocatable PAN-CEPH sensor, the CEPH extension is equipped with a dedicated head support unit with two available side rod lengths.

The CEPH application can be integrated at the time of purchase, but also retrofitted on equipment supplied in CEPH Ready version.



HEAD SUPPORT UNIT

The head support unit, which includes four partly adjustable contact points, guides the patient into the correct position for every kind of examination, including TMJ and maxillary sinus scanning.



CARPAL

The teleradiographic module includes a convenient support for carpal scanning.

CLINICAL EXCELLENCE IN 3D.

Detail-rich volumes for every clinical need while safeguarding patient health.

NewTom GO generates outstanding volumetric images and for each FOV, ranging from 6 x 6 to 10 x 10 cm, 3 protocols are available to better adjust the X-ray dose to diagnostic needs. User-friendly procedures help the dentist select the most appropriate examination and protocol, depending on the anatomical region of interest and according to clinical specialties - ranging from implantology to the measurement of maxillary sinus volumes, from endodontics to oral surgery.

aMAR

The aMAR (autoadaptive Metal Artifact Reduction) algorithm clearly shows the anatomical structures even when there are metal objects, such as amalgam or implants, that would impair image quality. This software function recognises the metal elements present and automatically generates an additional set of better quality images for a clearer view with artifacts reduced to a minimum.

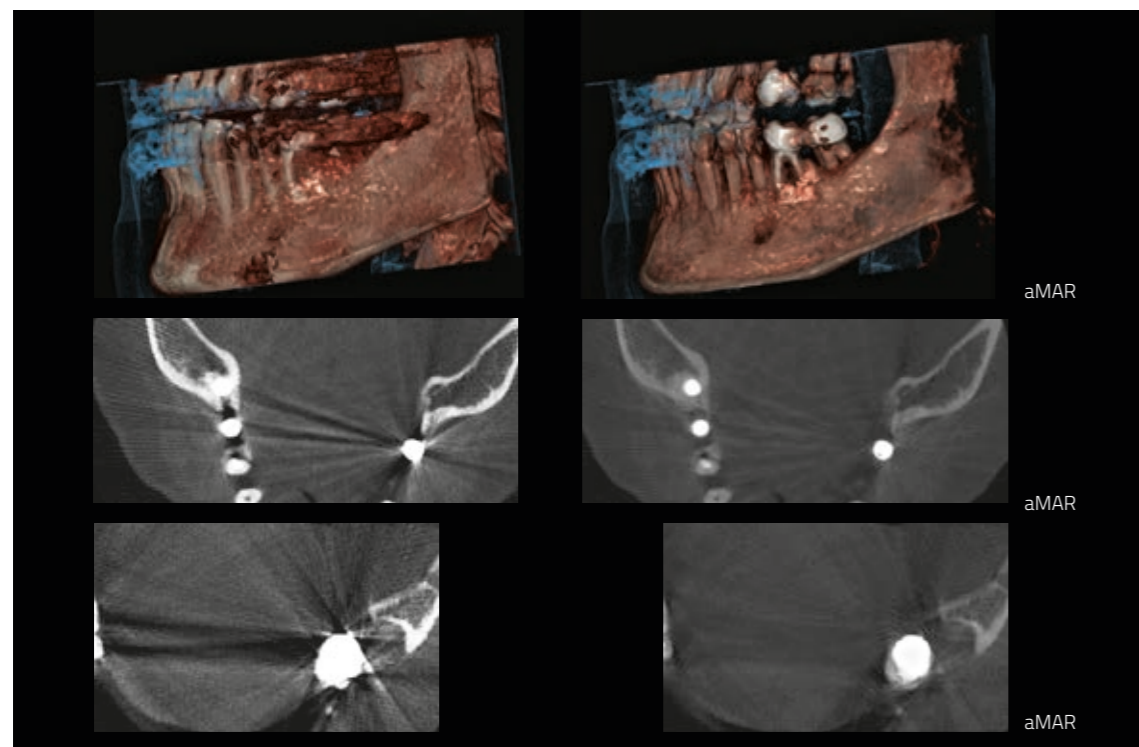

IMAGING 3D

OPTIMISED DOSE

A choice of 3 protocols allows the required X-ray dose to be adapted to specific needs: from very low for quick scans required by surgical follow-up checks, through regular for treatment planning, to a very high level of detail for the analysis of micro-structures.



COMPLETE ADULT DENTITION



The complete 10 x 10 cm FOV* is ideal to view inferior and superior third molar ratios with the complete dentition, including the maxillary sinus floor. Clear images even when there is metal or amalgam.

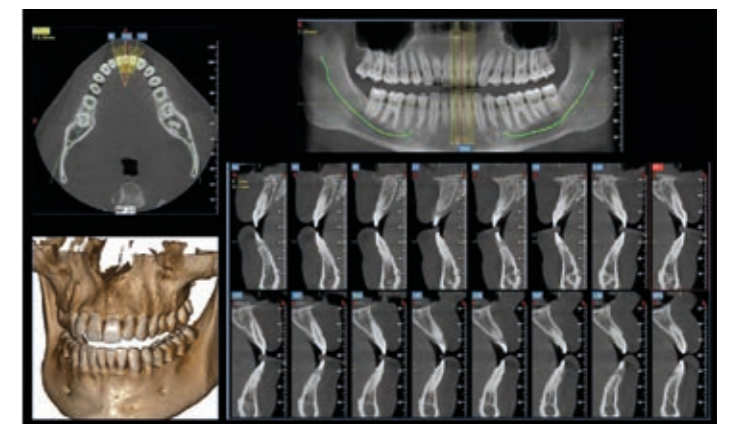

COMPLETE CHILD DENTITION

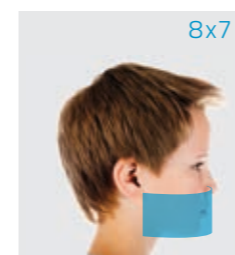

Small FOVs that are specific for paediatric applications can be chosen. The 8 x 7 cm volume offers high quality images of a child's complete dentition. It is especially useful for orthodontic applications and to diagnose more severe diseases, with always clear and detailed images as a result of filters to reduce artifacts.

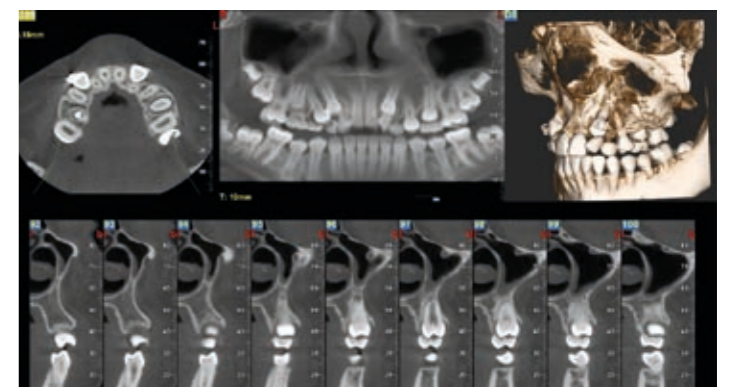

*3D FOVs 10x10, 10x7, 10x6, 8x10 could be disabled for dento-alveolar applications according to canadian requirements.

COMPLETE CHILD/ADULT SUPERIOR ARCH

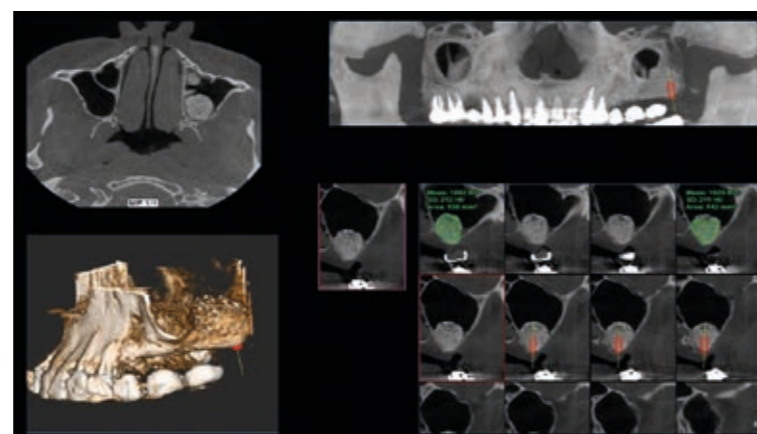

Volumes with FOV 8 x 6 cm and 10 x 6 cm* produce images of localised anatomical districts, such as, for example, a maxillary sinus with suitable lift to insert an implant. The ideal solution in the field of implantology to assess both implant site and bone density.

UPPER AND LOWER LOCAL INVESTIGATIONS

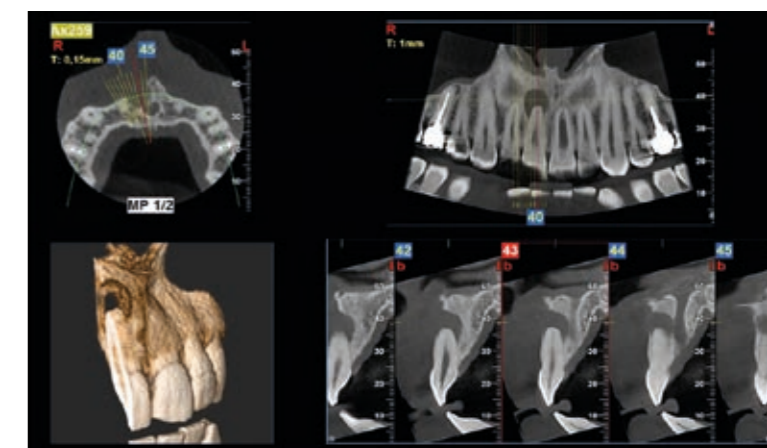
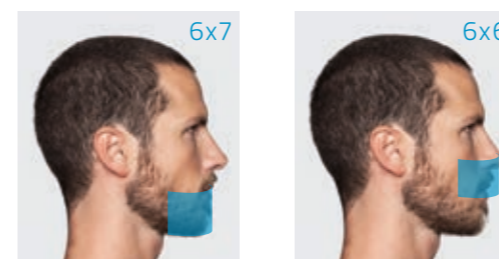

With FOVs 6 x 7 cm and 6 x 6 cm, scans can be performed with very high resolution to clearly see even the smallest detail. This mode is especially indicated for endodontic and periodontic applications.

COMPLETE CHILD/ADULT LOWER ARCH

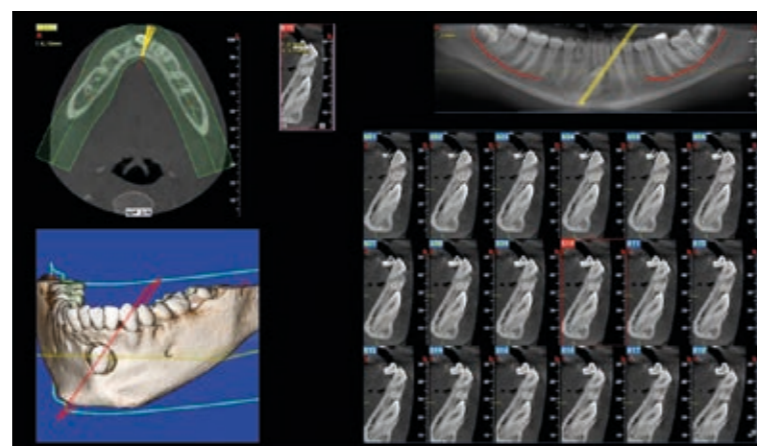

The 8 x 7 cm and 10 x 7 cm* FOVs are designed for analyses of the mandibular region. In the case of impacted canines, where it is necessary to assess their relationship with the mandibular canal and adjacent anatomical structures, the advanced image acquisition and processing functions allow to easily and rapidly highlight the slices of interest.

STUDYING ADULT/CHILD MAXILLARY SINUSES

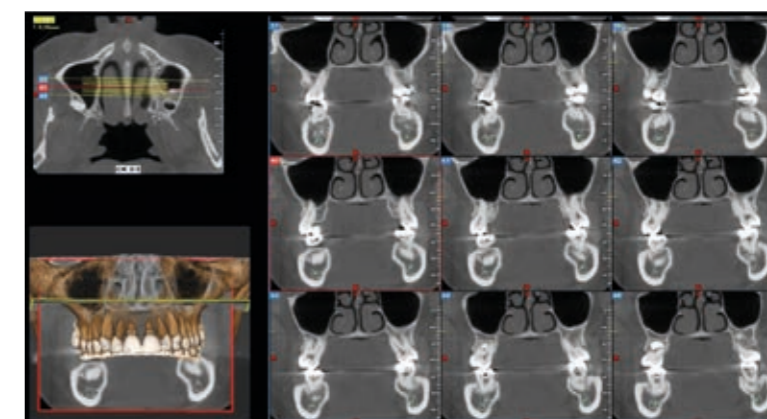
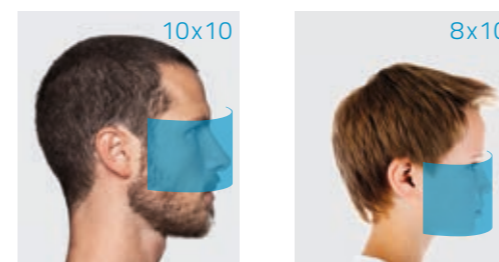

Complete view of maxillary sinuses and of upper airways, including the superior dental arch, using FOV 10 x 10 cm* and 8 x 10 cm*.

*3D FOVs 10x10, 10x7, 10x6, 8x10 could be disabled for dento-alveolar applications according to canadian requirements.

COMPLETE 2D VISION.

Consistently clear and homogeneous panoramic images thanks to ApT and aPAN technology.

GO 2D/3D offers quick and accurate diagnoses with several image acquisition software options designed to obtain high quality 2D images for all diagnostic needs.

Excellent, clear and detailed panoramic images with ApT (Autoadaptive picture Treatments) technology. The aPAN (adaptive PAN) function allows five layers of panoramic images to be captured in a single scan in order to choose the most suitable one for the scope of the examination.

ADULT PANORAMIC IMAGING

Standard panoramic software provides a complete, accurate view of the dental arches, maxillary sinuses and temporomandibular joints. The integrated feature of panoramic view orthogonal capturing perfectly highlights interproximal spaces and the entire root structure without any overlap.



CHILD PANORAMIC IMAGING

Child panoramic imaging with vertical collimation and low radiated dose: field of view and exposure are adapted to the paediatric patient's build.



IMAGING 2D

TEMPOROMANDIBULAR JOINT

The trajectories dedicated to the temporomandibular joints (TMJ) generate four projections with a single scan: two lateral and two postero-anterior, with mouth either open or closed.

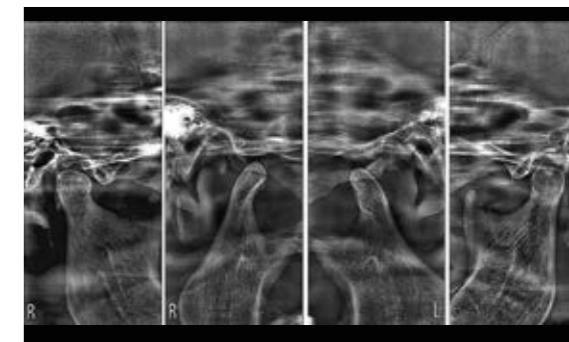

MAXILLARY SINUSES

The SIN software uses a focal layer that has been specially designed to improve maxillary sinus examinations. A dedicated support allows to obtain both frontal and lateral slices.

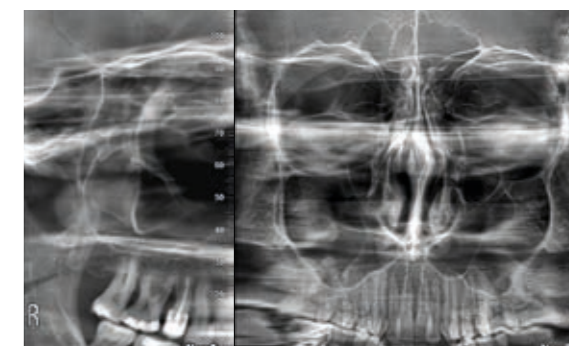

DENTITION

Clear detailed images limited only to the teeth, either whole or partial, with orthogonal projection and better signal-noise ratio. Ideal for periodontal controls.



BITEWING

Optimised collimated interproximal projection with a low dose to study dental crowns. An alternative to intraoral bitewings, with a less invasive and more comfortable procedure.

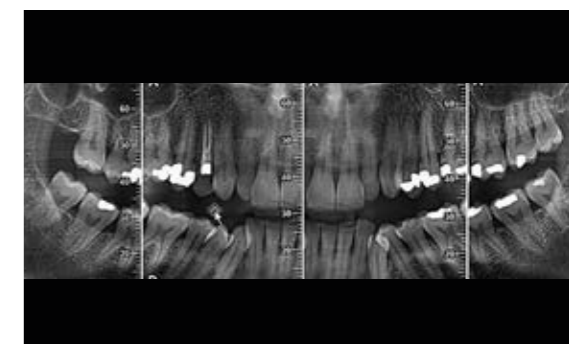

EXPANDING THE 2D VISION.

Clinical potential extended to meet all 2D diagnostic requirements through the CEPH arm.

Thanks to the integration of the teleradiographic arm, GO can respond to every 2D diagnostic need. High quality images are obtained for cephalometry and carpal examinations. All examinations are performed according to dedicated protocols for adults and children, optimised to reduce patient exposure based on actual scanning requirements. Accurate assessments before the application of dental braces, temporomandibular joint (TMJ) and maxillary sinus imaging, lateral and frontal teleradiographs. The use of longer ear guards for paediatric applications allows the skullcap to be included in the scan, while reducing thyroid exposure.



ApT (AUTOADAPTIVE PICTURE TREATMENTS)

Auto-adaptive filters automatically improve every 2D image to ensure the best result for every projection.

LATERAL CRANIAL TELERADIOGRAPHY

A.I. Automatic cephalometric tracing

Through lateral projections, detailed examinations of the bone structures with highlighted soft tissues are obtained, critically important for cephalometric studies. Try the innovative CEPH-X* online service for automatic cephalometric tracing based on an artificial intelligence algorithm.



FRONTAL CRANIAL TELERADIOGRAPHY

For the purpose of completing each treatment correctly, frontal projections can be used to scan for asymmetries and malocclusions.



CARPAL TELERADIOGRAPHY

Residual growth potential assessment through carpal examination. The dedicated support facilitates the correct performance of the scan.



*This is an independent software product. Verify with the local distributor whether this function is legally approved and available in your country. Not available in US and Canada.

MINIMUM DOSE, MAXIMUM DIAGNOSTIC QUALITY.

Advanced protocols and systems to reduce the radiated dose to a minimum.

Top quality imaging with a very low dose of radiations. Protocols defined by NewTom research in over 20 years of experience allow to automatically adapt exposure based on the anatomical characteristics of the patient, on the anatomical district examined and on actual diagnostic needs.

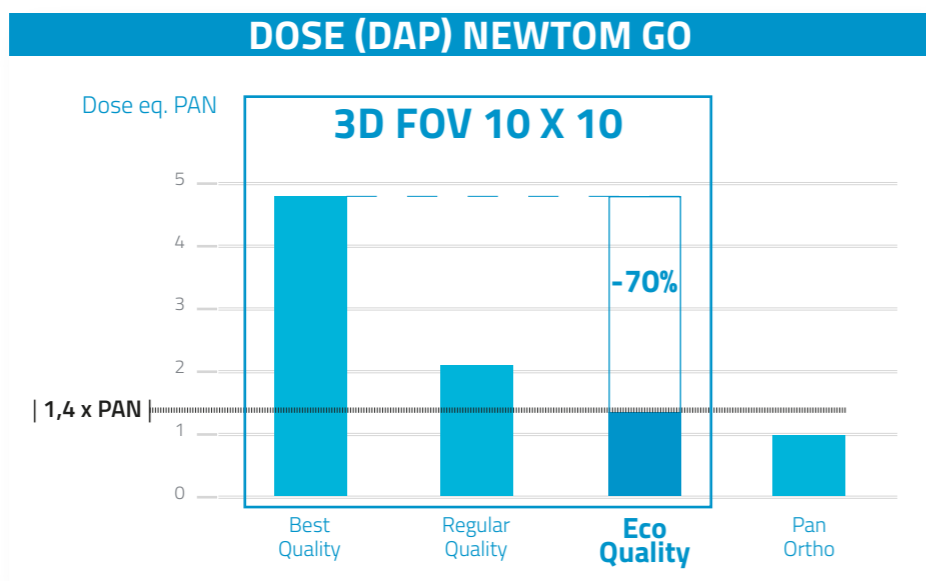

SAFEBEAM™

SafeBeam™ technology developed and patented by NewTom automatically adapts the radiated dose to the patient's anatomical characteristics in the chosen examination area, thus avoiding exposure to an unnecessarily high dose. An exclusive function that allows GO 2D/3D to control both power and intensity of radiations, and to obtain clear and detailed 2D and 3D images regardless of patient bone dimensions and density.



3.7s

ECO CEPH

Given the nature of a cephalometric examination, often used in cases of pedodontics, NewTom has developed a protocol that minimises the X-ray dose to which the patient is exposed. With a scan time limited to just 3.7 seconds, the patient benefits from minimal X-ray exposure and an extremely short time inside the device. In addition to the scanning mode, the longer ear guards protect the child's thyroid from unnecessary exposure during the examination.



6.4s

ECO SCAN AND ADAPTIVE FOV

NewTom, ever keen on patient health, was the first to use pulsed emission with CBCT technology applied to dental imaging, thus considerably reducing the dose of radiations emitted during 3D examinations. The introduction of the 3D ECO SCAN protocol (ultra rapid scan of only 6.4 seconds and actual emission time of only 1.6 seconds) provides the ideal solution for post-surgery follow-up examinations and for all situations where the X-ray dose must be kept to a minimum. Instead, the 3D aFOV (adaptive FOV) function allows the size of the radiated anatomical district to be limited in order to adapt to the different morphological features of adults and children or to simply perform sectional examinations up to a 6 x 6 cm FOV, with a minimum effective dose in ECO mode of 9 µSv.



6.6s

ECO PAN AND VARIABLE COLLIMATION

GO 2D/3D offers several PAN software options with variable collimation for adults and children, dedicated image acquisition for the dentition area only and bitewing views. The ECO PAN protocol allows an ultra rapid scan to be performed (6.6 seconds) to further reduce the radiation dose down to 5 µSv. Versatile, high quality 2D diagnoses with limited emission.



DOSESAVER

This hardware configuration allows high-quality panoramic images to be obtained - significantly reducing the emitted patient dose. Available in two pre-settable working modes, "80" and "100", which allows the PAN STANDARD scan dose to be reduced by a minimum of 20% to even exceed 40%. For 3D models, the DoseSaver 80 configuration is always combined with the latest generation **Focus PRO** algorithm, which allows image quality to be achieved regardless of the type of patient. It therefore reduces the need for repeated scans, compensating for possible positioning errors which could affect sharp focusing of significant details.

EXCELLENT ERGONOMICS AND ACCESSIBILITY.

Excellent comfort for fast and stable positioning of the patient.

Designed to ensure excellent positioning of the patient, GO 2D/3D allows to rapidly find the correct position for examinations that are always perfect. The device has an ideal functional structure for daily use that flawlessly merges into the clinic's diagnostic workflow. The outstanding ergonomic features of the device ensure excellent adaptability to every patient and, hence, ideal results for all applications.



EASY ACCESS

Extensive column scope and obstacle-free access to the scanning area allow to easily examine even patients with motor difficulties or in wheelchairs.

EXCELLENT POSITIONING

GO 2D/3D offers outstanding patient stability with stable and comfortable positioning, which is essential for perfect focusing and images that are always clear. The angled position of the rotary arm facilitates patient access and ensures a correct view for the operator. The column, which features a two-speed drive, reaches the desired height in a few seconds and precisely performs fine adjustments of patient position (e.g., for the Frankfurt Plane). The head support unit ensures exceptional stability with 5 contact points: three self-stabilising supports for head, bite and chin rest. Two metal handles for effective patient support and to ensure that the patient is correctly positioned during all the examination phases.



ACCURATE DIAGNOSES IN ALL CONDITIONS.

Automatic
technologically
advanced functions
ensure constant quality.

The self-adaptive functions of GO 2D/3D allow to perform accurate examinations with top quality, diagnostically valuable images.

The operator has tools for patient positioning and guided alignment to obtain perfect focusing.



GUIDED ALIGNMENT

Three laser guides and a wide front mirror allow quick and precise positioning of the patient. The device can be controlled by the operator via a user-friendly on-board keyboard or by using the dedicated App.



ALIGNMENT CHECKS

Before performing a 3D scan, two scout images allow to precisely check and adjust patient alignment via PC-controlled servo-assisted movements.

Focus PRO

Focus PRO is a new feature that delivers a single image always in focus and at high resolution instead of the 5 panoramic images with different focus levels of the aPAN (adaptive PAN) mode.

The output is a single image created automatically by selecting the most sharply focused pixels in each layer. In this way the highest possible image quality is achieved to facilitate diagnoses, while ensuring patient safety and avoiding any scan repeats.



VIRTUAL CONSOLE

Rapid and user-friendly image acquisition with the virtual console on PC or a dedicated software for iPad. The operator follows all examination phases, from the choice of an examination to scan start.

aPAN (DoseSaver 100)

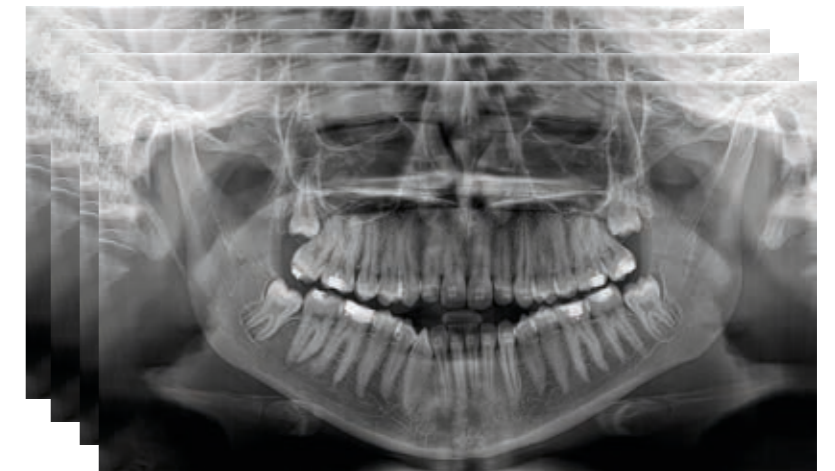

NEW Focus PRO (DoseSaver 80)

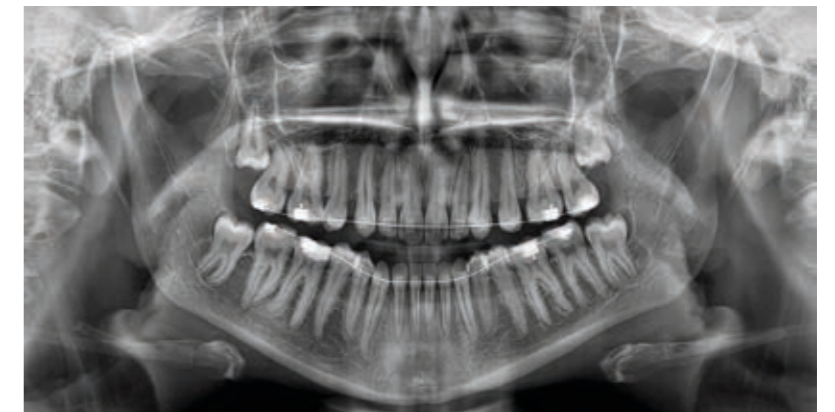

ADVANCED SOFTWARE FUNCTIONS.

Extensive sharing and processing power with the ultimate imaging platform.

NewTom's NNT software offers all functions required to perform, process, display and share 2D and 3D examinations. NNT also provides different application modes and functions specifically intended to plan the best treatment for implantology, endodontics, periodontics and radiology applications as well as maxillofacial surgery.



NNT 2D & 3D
All 2D/3D imaging tools in one certified software product that is perfectly integrated into the clinic's workflow.

NNT VOLUMETRIC IMPLANT SIMULATION

Rapid processing of 3D volumes acquired with realistic images to perform simulations either with implants present in the extensive library or with personalised ones. NNT functions allow the user to evaluate the 3D anatomical structures adjacent to the implant like the maxillary sinus anatomy. This 3D information permit to the dentist a better evaluation (compare to 2D images) of the implant size and its insertion axis. It is suggested to use it for better communication to explain the diagnostic case to the patient. The evaluation of morphological ratios performed on the 3D rendering allows tracing of lines directly on the virtual model, that simplifies the patient treatment planning. NIP* implant planning software permit simulation with volume and density analysis. Virtual endoscopy navigation ensures an even more intuitive dynamic analysis of the clinical data.

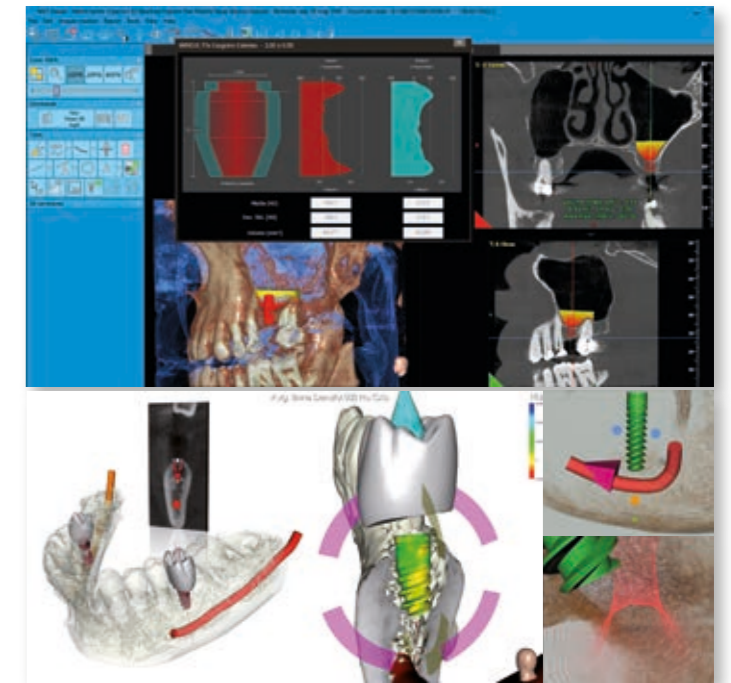

exocad PROSTHETICALLY GUIDED IMPLANT DESIGNING SOFTWARE exoplan* Core Version with TruSmile add-on module

exoplan is the high-performance and easy-to-use open software solution for prosthetically guided implant designing, created to offer maximum flexibility and a digital workflow featuring the highest level of usability and performance. With exoplan CBCT radiographic data can be aligned with intraoral scan or face scan data, making the most of the extra finishing tools provided to maximise alignment precision. The libraries available in exoplan include over 520 different implant systems, as well as more than 60,000 prosthetic components. The TruSmile module included in the supply ensures a virtually photorealistic level of detail in dental restoration rendering in real time during the design process, thus proving to be a powerful marketing tool for dentists who use chairside CAD/CAM systems, e.g. to talk a patient into opting for a ceramic restoration instead of a metal crown.

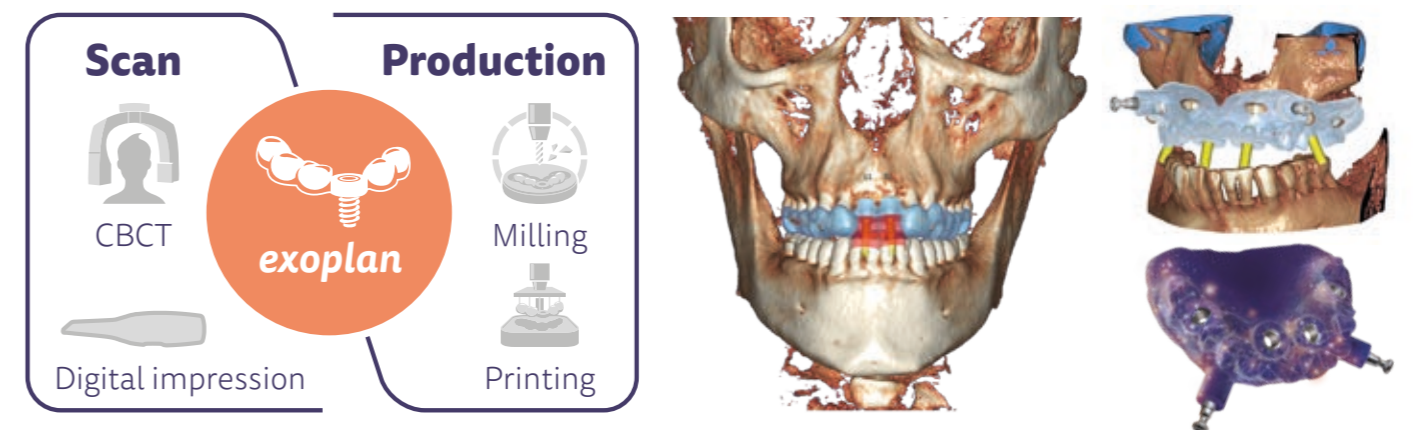

*This is an independent software product. Verify with the local distributor whether this function is legally approved and available in your country. NIP not available in US and Canada.

TOTAL SHARING DIAGNOSTICS, PROJECT AND PRODUCTION.

Advanced platform with cloud sharing for optimal management of implant treatment phases.

The dentist manages all the phases of implant rehabilitation in the smoothest, most effective way - being able to work on any device: PC, MAC and iPad. Cloud sharing of images and data for implantologist planning and dental technician operations are combined with support for the dentist, all to the advantage of the patient, whose therapy can be completed in the shortest possible time and having to undergo fewer treatment sessions.



NNT VIEWER (DEVICE&APP**)

The NNT software is characterised by user-friendliness and efficiency. It offers a rich set of tools for the management and sharing of diagnostic images, responding to typical clinical dentistry requirements. The 2D examination gallery is also compatible, via a free viewer, with iPad** systems ensuring even more extensive accessibility.

Creating NNT Viewer and exporting examination data in DICOM format are always guaranteed and included in the software. The NNT software is also compatible with the MAC platform through Parallels Desktop. Specialist/patient communication as well as communication with professionals who use other software is therefore guaranteed.



WORKFLOW ON CLOUD-BASED MULTI-PLATFORM

Using the multiple, constantly updated libraries of implants and abutments available on the cloud platform, implantologists can plan procedures and share data with dentists and technicians, also via secure chat lines. The platform allows for certified, optimised workflow designed for specialist clinical use, aimed at creating surgical templates by using 3DIEMME* services and/or the RealGUIDE DESIGN* software version and 3D printer. Among the many features available, there are importing and overlay of STL files, PLY of digital impressions and/or prosthetic design obtained via an optical scanner; simplified segmentation of the volumetric data of anatomical parts, exportable to STL; and project export to open CAD/CAM software for provisional implant management.



* This is an independent software product. Verify with the local distributor whether this function is legally approved and available in your country. RealGUIDE not available in US and Canada.
**Not available for US and Canada

COMPLETE CONNECTIVITY.

Excellent connectivity and integration with the modern systems adopted by NewTom. Workflow and clinical and diagnostic activities become much easier and highly performing.

VIRTUAL CONSOLE

Settings required for acquisition can be easily controlled from a remote virtual control panel on the PC, laptop, Windows tablet or iPad.

REMOTE ASSISTANCE AND I.O.T.

By connecting the device to the Internet, it is possible to carry out remote technical assistance and to monitor operation with Di.V.A. and Easy Check from an I.o.T. perspective. The device will send information on its own performance and any critical issues.

3D/2D VIEWER

Examinations can be shared with colleagues and patients by providing the Viewer directly on CD, DVD or a USB storage device.

1:1 PRINT

Complete and flexible report for storing and sharing colour reports on photographic paper or grey scale reports on X-ray-equivalent transparencies.

OTHER ACQUISITION DEVICES

Compatibility with TWAIN and DICOM 3.0 standards guarantees NNT software management of images from other 2D/3D image acquisition devices, such as video cameras, sensors, PSP and CBCT scanners.

MULTI-STATION DISPLAY AND PROCESSING

Image storage on a shared database in a local network that can be accessed from any workstation and iPad (only 2D). Management of multiple archives and access to password-protected data.

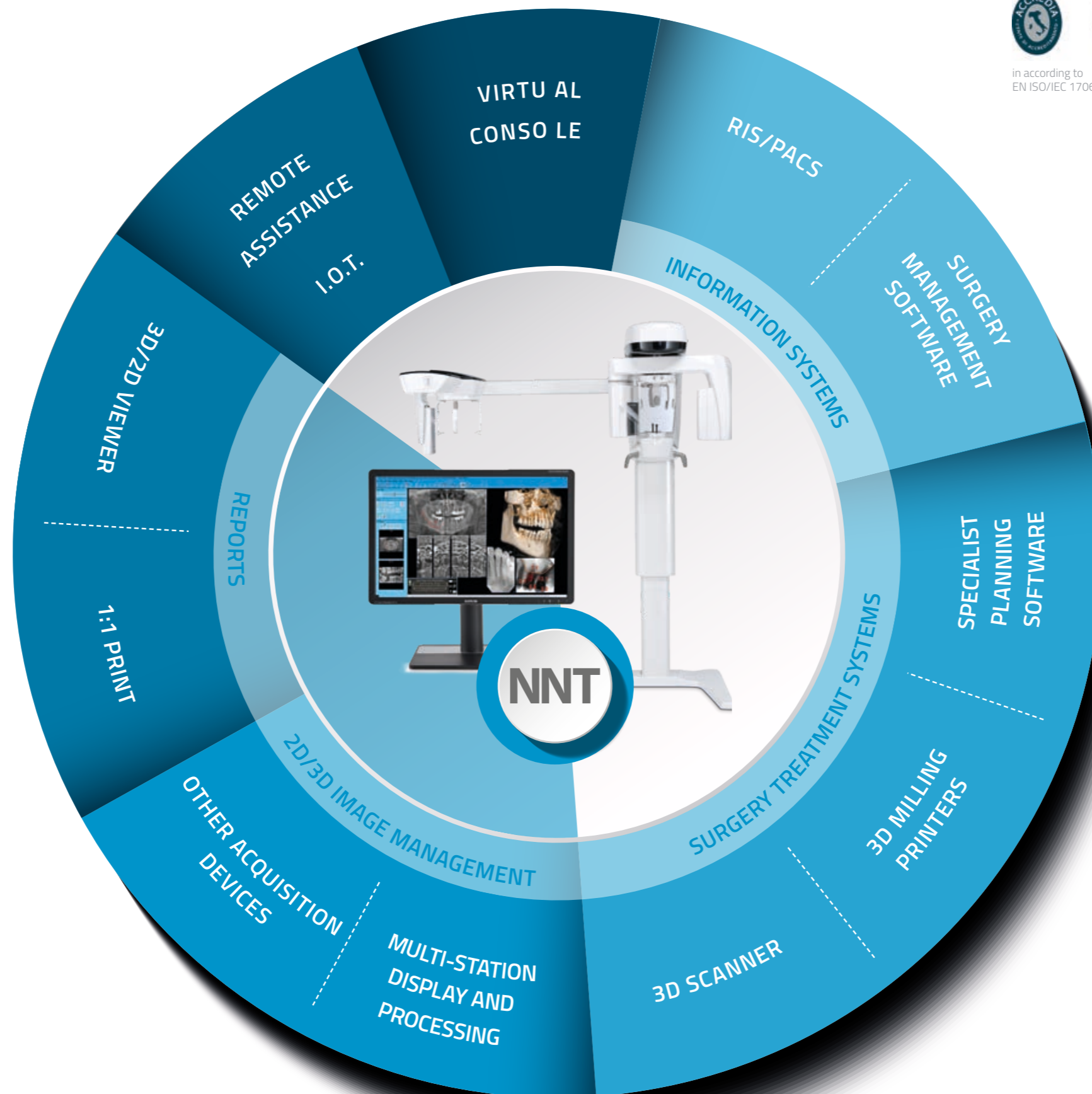

in according to
EN ISO/IEC 17065:2012

NNT: CERTIFIED SOFTWARE

NNT has been granted the ISDP® 10003 international scheme for data protection certification, to assess compliance with the European Regulation 2016/679 concerning the protection of individuals with regard to the processing of personal data.

Di.V.A. AND EASY CHECK

To ensure maximised workflow smoothness, the Di.V.A. digital virtual assistant provides data and usage statistics to plan workloads and maintenance. The Easy Check tool also ensures continuous remote technical monitoring, to facilitate maintenance scheduling and anticipate the resolution of any critical issues.

RIS/PACS

IHE compliant system that allows communication with RIS/PACS systems and DICOM printers. Complete services available: Print, Worklist, Storage Commitment, MPPS and Query/Retrieve.

SURGERY MANAGEMENT SOFTWARE

An open system designed for fast, efficient interfacing with the main dental surgery management software solutions via various standard VDDS, TWAIN and/or proprietary NNTBridge modes.

SPECIALIST PLANNING SOFTWARE

Exports in DICOM 3.0 format to specialist planning software to process orthodontic treatments, prostheses, implants, orthognathic and maxillofacial surgery.

3D MILLING PRINTERS

Software modules are available to segment the reconstructed volume and export to STL format the surfaces required to create 3D models that can underpin planning and treatment.

3D SCANNER

Prosthetically guided planning by integrating (via the dedicated software module) data in STL format from optical, intraoral or laboratory scanners, with volumetric data.

INDUSTRY 4.0.

TECHNICAL SPECIFICATIONS.

IMAGES	2D	3D
Type	Complete or partial adult and child panoramic imaging*, Orthogonal Panoramic ECO PAN, aPAN, Bitewing* Dentition, Frontal and Lateral (right and left) Maxillary sinuses, Temporomandibular Joint (2 x Lateral + 2 x Frontal), open and closed mouth. Teleradiography: AP-PA, LL Standard, Long, Quick, Carpal.	Complete examination of the 2 arches in a single scan for adults and children (reduced collimation). Studies of the maxillary region with maxillary sinuses*. Studies localised to region of interest.
(Maximum) theoretical resolution on the patient plane	2D: 5 - 6.9 lp/mm (pixel 100-73 µm) CEPH: 5.6 lp/mm (pixel 89 µm)	≥ 6 LP/mm (Voxel 80 µm minimum section thickness)
Equivalent radiograph size (cm)	PAN: 26.2 (length) x 14.4 (height) CEPH: 29.2 (length) x 22 (height)	-
Field of view (mm)	PAN: 210 (length) x 115 (height) CEPH: 258 (length) x 194 (height) PAN Child: 180 (length) x 100 (height) Dentition: 140 (length) x 100 (height) Bitewing: 167 (length) x 70 (height)	DENT and SIN**: 100 (diameter) x 100 (height) 100 (diameter) x 70 (height) 100 (diameter) x 60 (height) 80 (diameter) x 70 (height) 80 (diameter) x 60 (height) 80 (diameter) x 100 (height) 60 (diameter) x 70 (height) 60 (diameter) x 60 (height)
Maximum image data dimensions	PAN: 7.5 MB (single image) CEPH: 14 MB	720 MB
Magnification	PAN: 1.2 - 1.3 CEPH: 1.13	1 to 1 (Isotropic voxel)
Scan time	PAN: 13.7 s (ORTHO), 12.2 s (STD), 6.8 s (ECO) CEPH: 9.9 s (REG); 3.7 s (ECO)	BEST QUALITY: 16.8 s (High Resolution) REGULAR QUALITY: 9.6 s (Standard) ECO QUALITY: 6.4 s (Low Dose)
Estimate of typical effective dose (ICRP 103)	PAN: 5 - 9 µSv	FOV: 10x10 35 µSv (Voxel 160 µm) - 121 µSv (Voxel 80 µm) FOV: 6x6 9 µSv (Voxel 160 µm) - 40 µSv (Voxel 80 µm)
Minimum image display times	RealTime	15 s
Advanced filters	ApT (Autoadaptive Picture Treatments) Self-adaptive PAN	aMAR (Autoadaptive Metal Artifact Removal)

*Optional vertical collimation on 2D PAN version (included in the version "CEPH Ready" and 3D)
**3D FOVs 10x10, 10x7, 10x6, 8x10 could be disabled for dento-alveolar applications according to canadian requirements

X-RAY GENERATOR

VERSION	2D PAN or 2D PAN "CEPH READY" & 2D PAN-CEPH	3D PAN "CEPH READY" & 3D PAN-CEPH
Focal spot	0.5 mm (IEC 60336)	0.6 mm (IEC 60336)
Tensione anodica	60 kV – 85 kV continuous emission 60-70 kV continuous emission (only 2D PAN version*)	2D mode: 60 kV – 85 kV continuous emission 3D mode: 90 kV (pulsed mode)
Inherent filtration	> 2.5 mm Al eq. (at 85 kV)	2D: > 2.5 mm Al eq. (at 85 kV) 3D: 6 mm Al eq. (at 90 kV) - with automatic 3.5 mm filter
Generator type	Constant potential (DC)	
Anode current	4 mA - 15 mA	
Exposure control	SafeBeam™	
Maximum continuous anode input power	42 W (1:20 at 85 kV/ 10 mA)	
Embedded X-ray shielding behind receptor	IEC60601-1-3 compliant	

*Not available for US/Canada

DETECTOR

FUNCTION	PAN or PAN-CEPH	3D and PAN	CEPH
Type	CMOS (Csi)	Amorphous Silicon (CSI)	CMOS (Csi)
Dynamic range	14 bit (16,384 grey levels)	16 bit (65,536 grey levels)	14 bit (16,384 grey levels)

ERGONOMICS

Examination selection	Procedure guided from virtual control panel on PC and/or iPad
Patient positioning	Suggestion from virtual control panel - Servo-assisted alignment, 3 laser guides (Class 1 - IEC 60825-1) - 3D Scout View
Patient positioning	Efficient 4 contact point 2D version - 5 contact point version, adjustable 3D/2D right/left
Adjustments	2-speed height adjustment drive Keypad on machine and/or iPad app Servo-assisted alignment: Keypad on machine or remote control (via Scout View)
Other functions	Multilingual, parking position, remote control
Notes	Easy access for patients in wheelchairs

CONNECTIVITY

Connections	LAN / Ethernet
Software	NewTom NNT (ISDP®10003:2020 compliant in accordance with EN ISO/IEC 17065:2012 certificate number 2019003109-2) and iPad App* - NNT viewer (free), STL (NIP*; RealGUIDE*; EXOCAD)
Supported protocols	DICOM 3.0, TWAIN, VDDS, CLOUD shared (NIP*; RealGUIDE*; EXOCAD)
DICOM nodes	IHE compliant (Print; Storage Commitment; WorkList MPPS; Query/Retrieve)
iPad App	Virtual control panel for the device and for the NNT 2D viewer*
IOT - Remote Monitoring	Di.V.A. WEB-based applications & Easy Echeck with profiled user access (ISDP®10003:2020 compliant in accordance with EN ISO/IEC 17065:2012 certificate number 2020003704-2)

*Not available for US and Canada

INSTALLATION

Minimum space requirement (L x D)	CEPH Ready version: 872 x 1030 mm CEPH version: 1785 x 1030 mm
Package dimensions (L) x (D) x (H) in mm	Box1: 930 x 690 x 960 (base machine) Box2: 1860 x 355 x 350 (floor-mounted) Box3: 575 x 1275 x 380 (teleradiographic arm)
Weight	2D version: 87 kg (192 lb) 3D/2D version: 99 kg (218 lb) CEPH option: 21 kg (46 lb)
Accessories	Free standing base

POWER SUPPLY

Voltage Frequency	115 – 240 V single-phase 50 / 60 Hz
Maximum absorbed surge current	20 A at 115 V; 12 A at 240 V
Current absorption in standby mode	Maximum 0,5 A (240 V); 1 A (115 V)
Notes	Automatic adaptation for voltage and frequency

Specifications subject to change without prior notice.

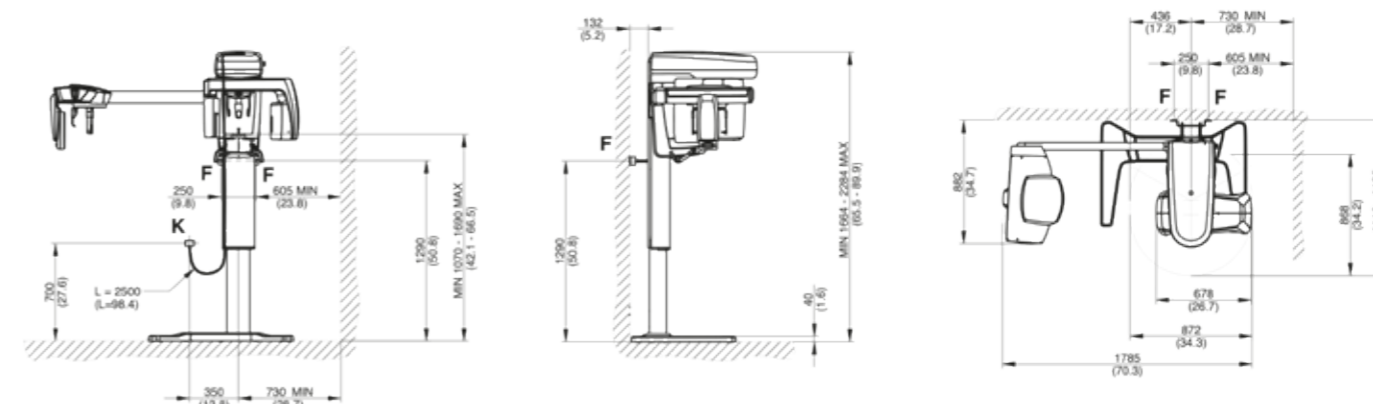

Dimensions in millimetres
(dimensions in inches)



0051



*Not available for US and Canada